



AD8510/AD8512/AD8513

FEATURES

- Fast settling time: 500 ns to 0.1%
- Low offset voltage: 400 μ V max
- Low T_cV_{os} : 1 μ V/ $^{\circ}$ C typ
- Low input bias current: 25 pA typ
- Dual-supply operation: ± 5 V to ± 15 V
- Low noise: 8 nV/ $\sqrt{\text{Hz}}$
- Low distortion: 0.0005%
- No phase reversal
- Unity gain stable

APPLICATIONS

- Instrumentation
- Multipole filters
- Precision current measurement
- Photodiode amplifiers
- Sensors
- Audio

GENERAL DESCRIPTION

The AD8510, AD8512, AD8513 are single-, dual-, and quad-precision JFET amplifiers that feature low offset voltage, input bias current, input voltage noise, and input current noise.

The combination of low offsets, low noise, and very low input bias currents makes these amplifiers especially suitable for high impedance sensor amplification and precise current measurements using shunts. The combination of dc precision, low noise, and fast settling time results in superior accuracy in medical instruments, electronic measurement, and automated test equipment. Unlike many competitive amplifiers, the AD8510/AD8512/AD8513 maintain their fast settling performance even with substantial capacitive loads. Unlike many older JFET amplifiers, the AD8510/AD8512/AD8513 do not suffer from output phase reversal when input voltages exceed the maximum common-mode voltage range.

Rev. E

Information furnished by Analog Devices is believed to be accurate and reliable. However, no responsibility is assumed by Analog Devices for its use, nor for any infringements of patents or other rights of third parties that may result from its use. Specifications subject to change without notice. No license is granted by implication or otherwise under any patent or patent rights of Analog Devices. Trademarks and registered trademarks are the property of their respective owners.

PIN CONFIGURATIONS

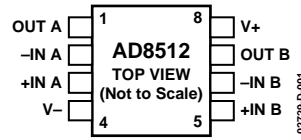

Figure 1. 8-Lead MSOP (RM Suffix)

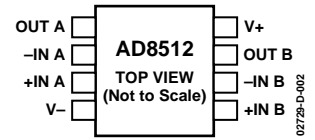

Figure 2. 8-Lead SOIC (R Suffix)

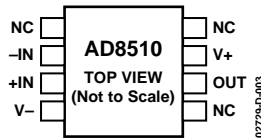

Figure 3. 8-Lead MSOP (RM Suffix)

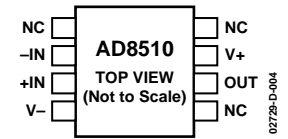

Figure 4. 8-Lead SOIC (R Suffix)

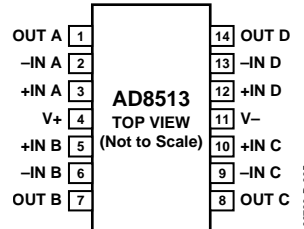

Figure 5. 14-Lead SOIC (R Suffix)

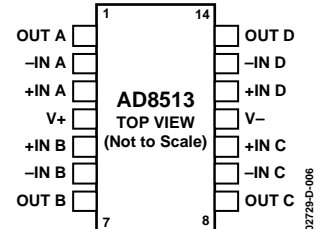

Figure 6. 14-Lead TSSOP (RU Suffix)

Fast slew rate and great stability with capacitive loads make the AD8510/AD8512/AD8513 a perfect fit for high performance filters. Low input bias currents, low offset, and low noise result in a wide dynamic range of photodiode amplifier circuits. Low noise and distortion, high output current, and excellent speed make the AD8510/AD8512/AD8513 a great choice for audio applications.

The AD8510/AD8512 are both available in 8-lead narrow SOIC and 8-lead MSOP packages. MSOP packaged parts are only available in tape and reel. The AD8513 is available in 14-lead SOIC and TSSOP packages.

The AD8510/AD8512/AD8513 are specified over the -40°C to $+125^{\circ}\text{C}$ extended industrial temperature range.

TABLE OF CONTENTS

Specifications.....	3	Total Noise Including Source Resistors	13
Electrical Characteristics	4	Settling Time.....	14
Absolute Maximum Ratings	6	Overload Recovery Time	14
ESD Caution.....	6	Capacitive Load Drive	14
Typical Performance Characteristics	7	Open-Loop Gain and Phase Response.....	15
General Application Information.....	13	Precision Rectifiers.....	16
Input Overvoltage Protection	13	I-V Conversion Applications	17
Output Phase Reversal.....	13	Outline Dimensions	19
THD + Noise.....	13	Ordering Guide	20

REVISION HISTORY

6/04—Data Sheet Changed from Rev. D to Rev. E

Changes to Format	Universal
Changes to Specifications	3
Updated Outline Dimensions	19

10/03—Data Sheet Changed from Rev. C to Rev. D

Added AD8513 Model	Universal
Changes to Specifications	3
Added Figures 36 through 40.....	10
Added new Figures 55 and 57.....	17
Changes to Ordering Guide	20

9/03—Data Sheet Changed from Rev. B to Rev. C

Changes to Ordering Guide	4
Updated Figure 2	10
Changes to Input Overvoltage Protection section	10
Changes to Figures 10 and 11	12
Changes to Photodiode Circuits section	13
Changes to Figures 13 and 14	13
Deleted Precision Current Monitoring section	14
Updated Outline Dimensions	15

3/03—Data Sheet Changed from Rev. A to Rev. B

Updated Figure 5	11
Updated Outline Dimensions	15

8/02—Data Sheet Changed from Rev. 0 to Rev. A

Added AD8510 Model.....	Universal
Added Pin Configurations	1
Changes to Specifications.....	2
Changes to Ordering Guide	4
Changes to TPCs 2 and 3.....	5
Added new TPCs 10 and 12.....	6
Replaced TPC 20	8
Replaced TPC 27	9
Changes to General Application Information Section	10
Changes to Figure 5.....	11
Changes to I-V Conversion Applications Section.....	13
Changes to Figures 13 and 14	13
Changes to Figure 17.....	14

SPECIFICATIONS

@ $V_S = \pm 5\text{ V}$, $V_{CM} = 0\text{ V}$, $T_A = 25^\circ\text{C}$, unless otherwise noted.

Table 1.

Parameter	Symbol	Conditions	Min	Typ	Max	Unit
INPUT CHARACTERISTICS						
Offset Voltage (B Grade) ¹	V_{OS}	$-40^\circ\text{C} < T_A < +125^\circ\text{C}$		0.08	0.4	mV
Offset Voltage (A Grade)	V_{OS}	$-40^\circ\text{C} < T_A < +125^\circ\text{C}$		0.1	0.8	mV
Input Bias Current	I_B	$-40^\circ\text{C} < T_A < +85^\circ\text{C}$		21	75	pA
Input Offset Current	I_{OS}	$-40^\circ\text{C} < T_A < +125^\circ\text{C}$			0.7	nA
		$-40^\circ\text{C} < T_A < +125^\circ\text{C}$			7.5	nA
Input Offset Current	I_{OS}	$-40^\circ\text{C} < T_A < +85^\circ\text{C}$		5	50	pA
		$-40^\circ\text{C} < T_A < +125^\circ\text{C}$			0.3	nA
		$-40^\circ\text{C} < T_A < +125^\circ\text{C}$			0.5	nA
Input Capacitance						
Differential				12.5		pF
Common-Mode				11.5		pF
Input Voltage Range			-2.0		+2.5	V
Common-Mode Rejection Ratio	CMRR	$V_{CM} = -2.0\text{ V to }+2.5\text{ V}$	86	100		dB
Large Signal Voltage Gain	A_{VO}	$R_L = 2\text{ k}\Omega$, $V_O = -3\text{ V to }+3\text{ V}$	65	107		V/mV
Offset Voltage Drift (B Grade) ¹	$\Delta V_{OS}/\Delta T$			0.9	5	$\mu\text{V}/^\circ\text{C}$
Offset Voltage Drift (A Grade)	$\Delta V_{OS}/\Delta T$			1.7	12	$\mu\text{V}/^\circ\text{C}$
OUTPUT CHARACTERISTICS						
Output Voltage High	V_{OH}	$R_L = 10\text{ k}\Omega$	+4.1	+4.3		V
Output Voltage Low	V_{OL}	$-40^\circ\text{C} < T_A < +125^\circ\text{C}$		-4.9	-4.7	V
Output Voltage High	V_{OH}	$R_L = 2\text{ k}\Omega$,	+3.9	+4.2		V
Output Voltage Low	V_{OL}	$-40^\circ\text{C} < T_A < +125^\circ\text{C}$		-4.9	-4.5	V
Output Voltage High	V_{OH}	$R_L = 600\ \Omega$	+3.7	+4.1		V
Output Voltage Low	V_{OL}	$-40^\circ\text{C} < T_A < +125^\circ\text{C}$		-4.8	-4.2	V
Output Current	I_{OUT}		± 40	± 54		mA
POWER SUPPLY						
Power Supply Rejection Ratio	PSRR	$V_S = \pm 4.5\text{ V to } \pm 18\text{ V}$	86	130		dB
Supply Current/Amplifier	I_{SY}	$V_O = 0\text{ V}$		2.0	2.3	mA
AD8510/AD8512/AD8513		$-40^\circ\text{C} < T_A < +125^\circ\text{C}$			2.5	mA
AD8510/AD8512		$-40^\circ\text{C} < T_A < +125^\circ\text{C}$			2.75	mA
AD8513		$-40^\circ\text{C} < T_A < +125^\circ\text{C}$				mA
DYNAMIC PERFORMANCE						
Slew Rate	SR	$R_L = 2\text{ k}\Omega$		20		V/ μs
Gain Bandwidth Product	GBP			8		MHz
Settling Time	t_s	To 0.1%, 0 V to 4 V Step, $G = +1$		0.4		μs
THD + Noise	THD + N	1 kHz, $G = +1$, $R_L = 2\text{ k}\Omega$		0.0005		%
Phase Margin	Φ_O			44.5		Degrees
NOISE PERFORMANCE						
Voltage Noise Density	e_n	$f = 10\text{ Hz}$		34		nV/ $\sqrt{\text{Hz}}$
		$f = 100\text{ Hz}$		12		nV/ $\sqrt{\text{Hz}}$
		$f = 1\text{ kHz}$		8.0	10	nV/ $\sqrt{\text{Hz}}$
		$f = 10\text{ kHz}$		7.6		nV/ $\sqrt{\text{Hz}}$
Peak-to-Peak Voltage Noise	$e_n\text{ p-p}$	0.1 Hz to 10 Hz Bandwidth		2.4	5.2	$\mu\text{V p-p}$

¹ AD8510/AD8512 only.

AD8510/AD8512/AD8513

ELECTRICAL CHARACTERISTICS

@ $V_S = \pm 15\text{ V}$, $V_{CM} = 0\text{ V}$, $T_A = 25^\circ\text{C}$, unless otherwise noted.

Table 2.

Parameter	Symbol	Conditions	Min	Typ	Max	Unit	
INPUT CHARACTERISTICS							
Offset Voltage (B Grade) ¹	V_{OS}	$-40^\circ\text{C} < T_A < +125^\circ\text{C}$		0.08	0.4	mV	
					0.8	mV	
Offset Voltage (A Grade)	V_{OS}	$-40^\circ\text{C} < T_A < +125^\circ\text{C}$		0.1	1.0	mV	
					1.8	mV	
Input Bias Current	I_B	$-40^\circ\text{C} < T_A < +85^\circ\text{C}$ $-40^\circ\text{C} < T_A < +125^\circ\text{C}$		25	80	pA	
					0.7	nA	
Input Offset Current	I_{OS}	$-40^\circ\text{C} < T_A < +85^\circ\text{C}$ $-40^\circ\text{C} < T_A < +125^\circ\text{C}$		6	75	pA	
					0.3	nA	
Input Capacitance							
			Differential		12.5		pF
Common-Mode				11.5		pF	
Input Voltage Range			-13.5		+13.0	V	
Common-Mode Rejection Ratio	CMRR	$V_{CM} = -12.5\text{ V to }+12.5\text{ V}$	86	108		dB	
Large Signal Voltage Gain	A_{VO}	$V_O = -13.5\text{ V to }+13.5\text{ V}$ $R_L = 2\text{ k}\Omega$, $V_{CM} = 0\text{ V}$		115	196		V/mV
Offset Voltage Drift (B Grade) ¹	$\Delta V_{OS}/\Delta T$			1.0	5	$\mu\text{V}/^\circ\text{C}$	
Offset Voltage Drift (A Grade)	$\Delta V_{OS}/\Delta T$			1.7	12	$\mu\text{V}/^\circ\text{C}$	
OUTPUT CHARACTERISTICS							
Output Voltage High	V_{OH}	$R_L = 10\text{ k}\Omega$	+14.0	+14.2		V	
Output Voltage Low	V_{OL}	$-40^\circ\text{C} < T_A < +125^\circ\text{C}$		-14.9	-14.6	V	
Output Voltage High	V_{OH}	$R_L = 2\text{ k}\Omega$	+13.8	+14.1		V	
Output Voltage Low	V_{OL}	$-40^\circ\text{C} < T_A < +125^\circ\text{C}$		-14.8	-14.5	V	
Output Voltage High	V_{OH}	$R_L = 600\ \Omega$, $T_A = 25^\circ\text{C}$ $-40^\circ\text{C} < T_A < +125^\circ\text{C}$		+13.5	+13.9	V	
				11.4		V	
Output Voltage Low	V_{OL}	$R_L = 600\ \Omega$, $T_A = 25^\circ\text{C}$ $-40^\circ\text{C} < T_A < +125^\circ\text{C}$			-14.3	V	
					-13.8	V	
Output Current	I_{OUT}			± 70		mA	
POWER SUPPLY							
Power Supply Rejection Ratio	PSRR	$V_S = \pm 4.5\text{ V to } \pm 18\text{ V}$	86			dB	
Supply Current/Amplifier	I_{SY}	$V_O = 0\text{ V}$ $-40^\circ\text{C} < T_A < +125^\circ\text{C}$ $-40^\circ\text{C} < T_A < +125^\circ\text{C}$		2.2	2.5	mA	
			AD8510/AD8512/AD8513			2.6	mA
			AD8510/AD8512 AD8513			3.0	mA
DYNAMIC PERFORMANCE							
Slew Rate	SR	$R_L = 2\text{ k}\Omega$		20		V/ μs	
Gain Bandwidth Product	GBP			8		MHz	
Settling Time	t_s	To 0.1%, 0 V to 10 V Step, $G = +1$ To 0.01%, 0 V to 10 V Step, $G = +1$		0.5		μs	
				0.9		μs	
THD + Noise	THD + N	1 kHz, $G = +1$, $R_L = 2\text{ k}\Omega$		0.0005		%	
Phase Margin	Φ_O			52		Degrees	

AD8510/AD8512/AD8513

Parameter	Symbol	Conditions	Min	Typ	Max	Unit
NOISE PERFORMANCE						
Voltage Noise Density	e_n	f = 10 Hz f = 100 Hz f = 1 kHz f = 10 kHz		34 12 8.0 7.6		nV/ $\sqrt{\text{Hz}}$ nV/ $\sqrt{\text{Hz}}$ nV/ $\sqrt{\text{Hz}}$ nV/ $\sqrt{\text{Hz}}$
Peak-to-Peak Voltage Noise	e_n p-p	0.1 Hz to 10 Hz Bandwidth		2.4	5.2	μV p-p

¹ AD8510/AD8512 only.

ABSOLUTE MAXIMUM RATINGS

Table 3. AD8510/AD8512/AD8513 Stress Ratings¹

Parameter	Rating
Supply Voltage	±18 V
Input Voltage	±V _s
Output Short-Circuit Duration to GND	Observe Derating Curves
Storage Temperature Range R, RM Packages	−65°C to +150°C
Operating Temperature Range	−40°C to +125°C
Junction Temperature Range R, RM Packages	−65°C to +150°C
Lead Temperature Range (Soldering, 10 sec)	300°C
Electrostatic Discharge (HBM)	2000 V

Table 4. Thermal Resistance

Package Type	θ_{JA} ²	θ_{JC}	Unit
8-Lead MSOP (RM)	210	45	°C/W
8-Lead SOIC (R)	158	43	°C/W
14-Lead SOIC (R)	120	36	°C/W
14-Lead TSSOP (RU)	180	35	°C/W

¹ Stresses above those listed under Absolute Maximum Ratings may cause permanent damage to the device. This is a stress rating only; functional operation of the device at these or any other conditions above those listed in the operational sections of this specification is not implied. Exposure to absolute maximum rating conditions for extended periods may affect device reliability.

² θ_{JA} is specified for worst-case conditions, i.e., θ_{JA} is specified for device soldered in circuit board for surface-mount packages.

ESD CAUTION

ESD (electrostatic discharge) sensitive device. Electrostatic charges as high as 4000 V readily accumulate on the human body and test equipment and can discharge without detection. Although this product features proprietary ESD protection circuitry, permanent damage may occur on devices subjected to high energy electrostatic discharges. Therefore, proper ESD precautions are recommended to avoid performance degradation or loss of functionality.



TYPICAL PERFORMANCE CHARACTERISTICS

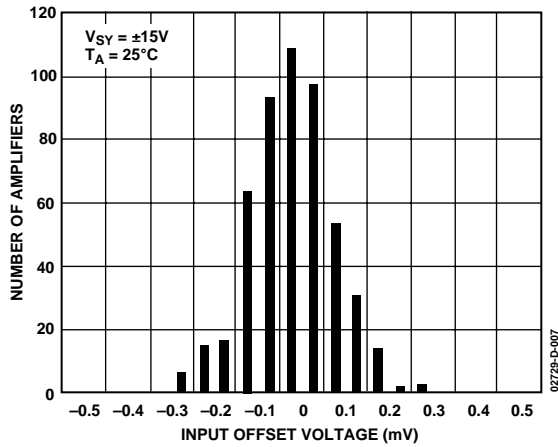

Figure 7. Input Offset Voltage Distribution

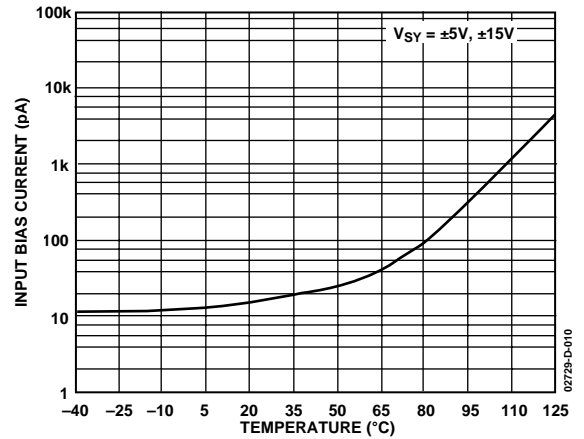

Figure 10. Input Bias Current vs. Temperature

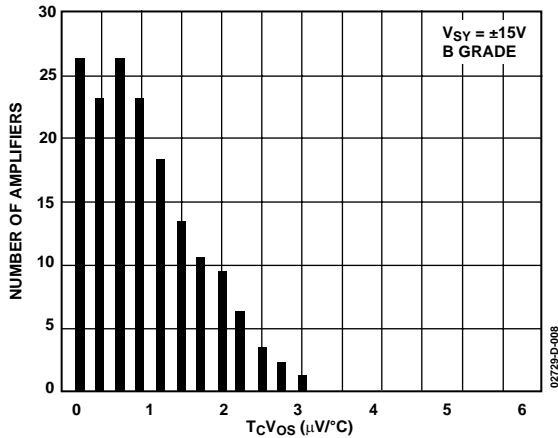

Figure 8. AD8510/AD8512 $T_C V_{OS}$ Distribution

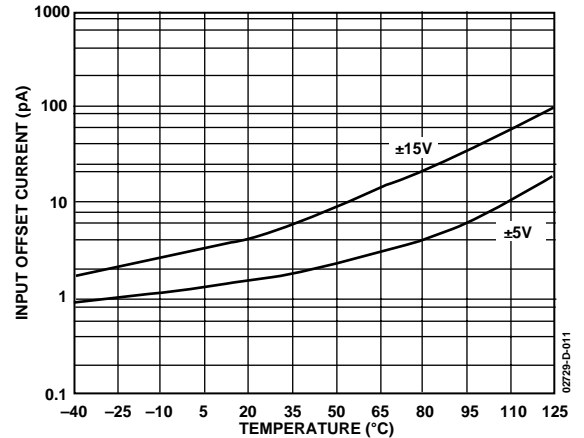

Figure 11. Input Offset Current vs. Temperature

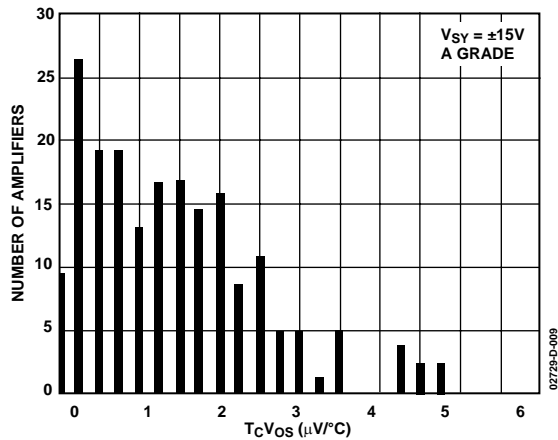

Figure 9. AD8510/AD8512 $T_C V_{OS}$ Distribution

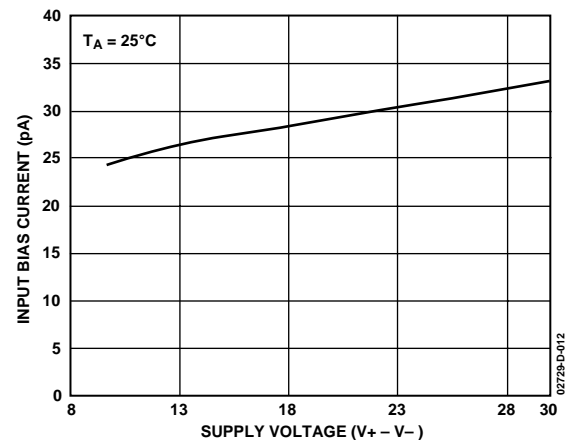

Figure 12. Input Bias Current vs. Supply Voltage

AD8510/AD8512/AD8513

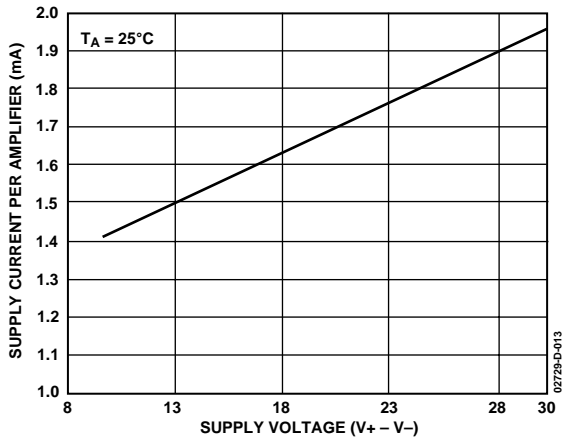

Figure 13. AD8512 Supply Current per Amplifier vs. Supply Voltage

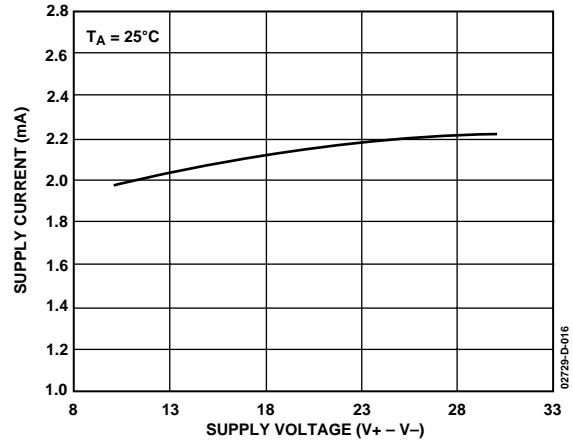

Figure 16. AD8510 Supply Current vs. Supply Voltage

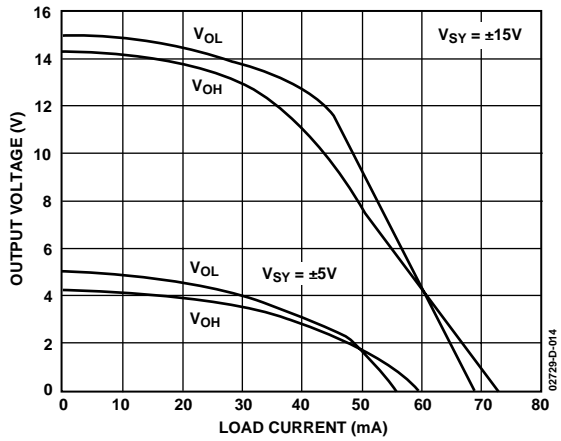

Figure 14. AD8510/AD8512 Output Voltage vs. Load Current

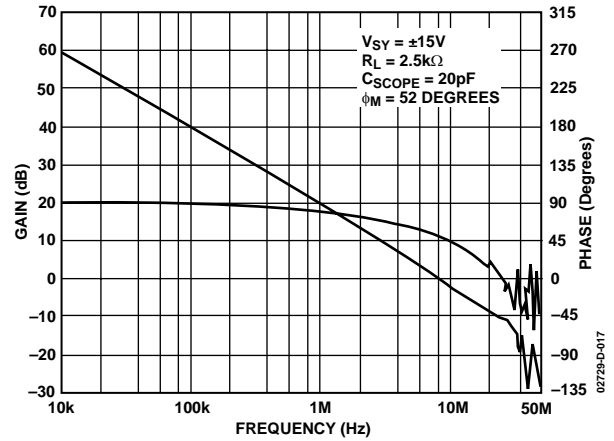

Figure 17. Open-Loop Gain and Phase vs. Frequency

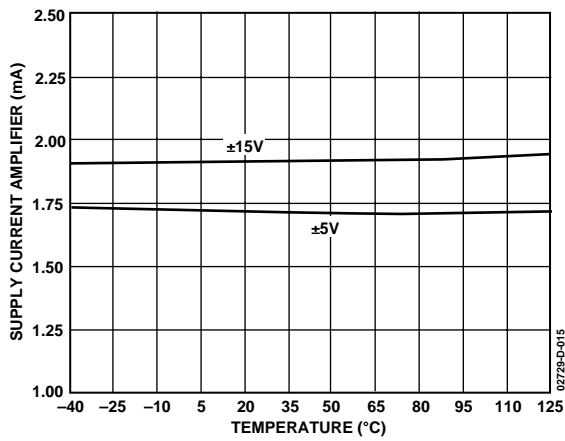

Figure 15. AD8512 Supply Current per Amplifier vs. Temperature

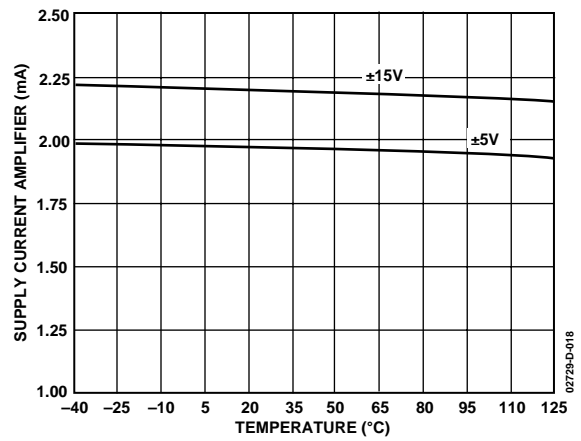

Figure 18. AD8510 Supply Current vs. Temperature

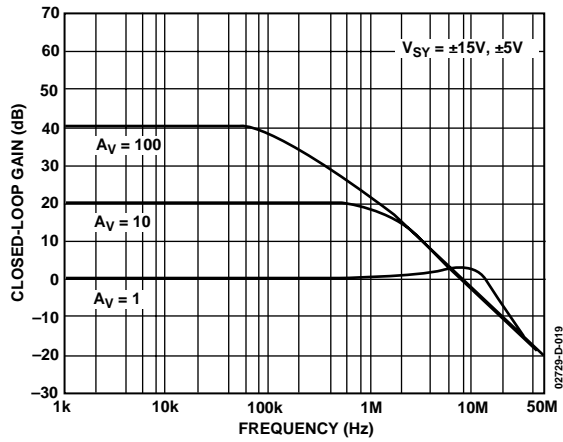

Figure 19. Closed-Loop Gain vs. Frequency

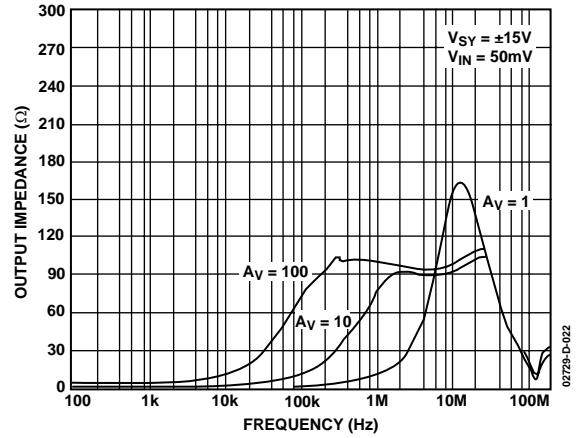

Figure 22. Output Impedance vs. Frequency

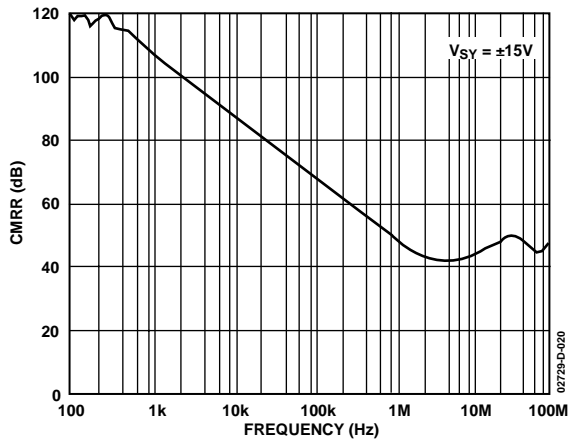

Figure 20. CMRR vs. Frequency

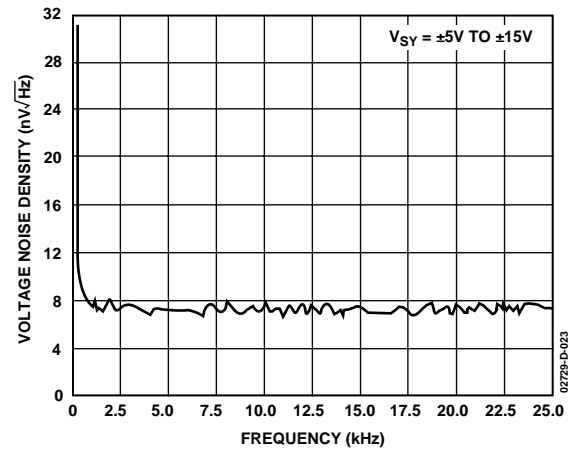

Figure 23. Voltage Noise Density

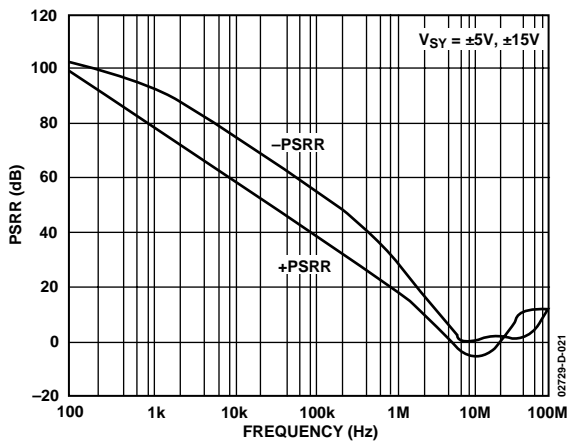

Figure 21. PSRR vs. Frequency

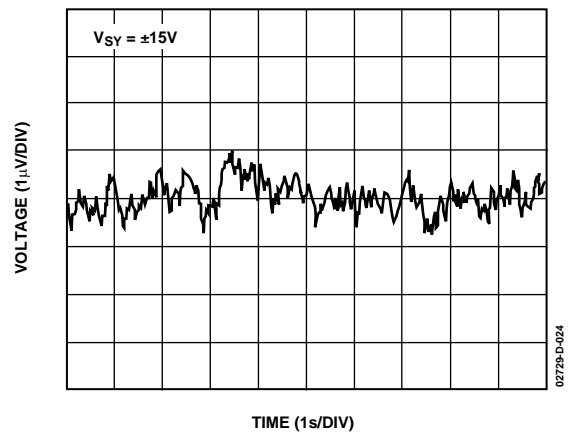

Figure 24. 0.1 Hz to 10 Hz Input Voltage Noise

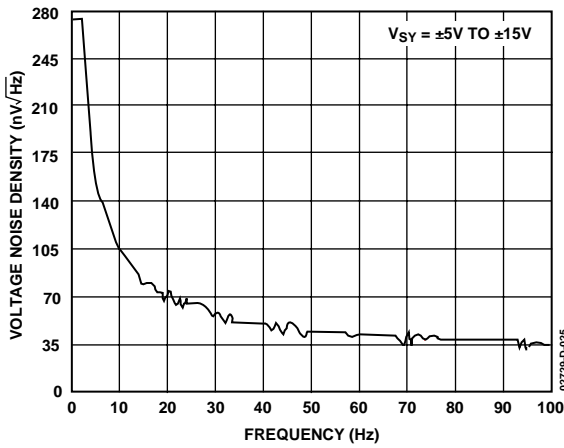

Figure 25. Voltage Noise Density vs. Frequency

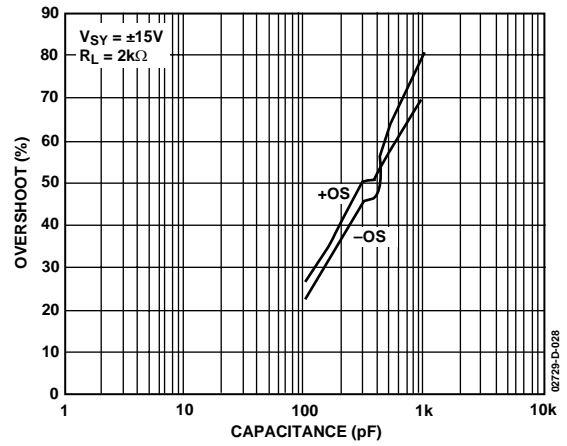

Figure 28. Small Signal Overshoot vs. Load Capacitance

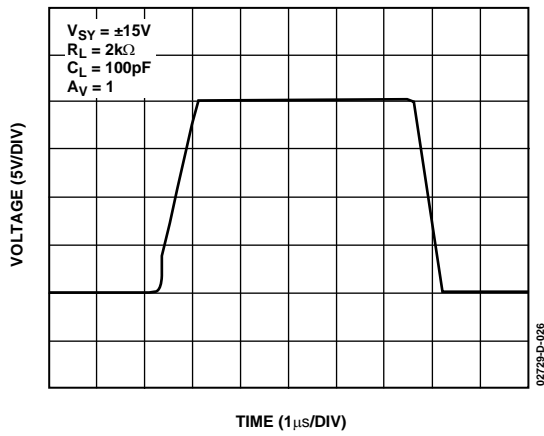

Figure 26. Large Signal Transient Response

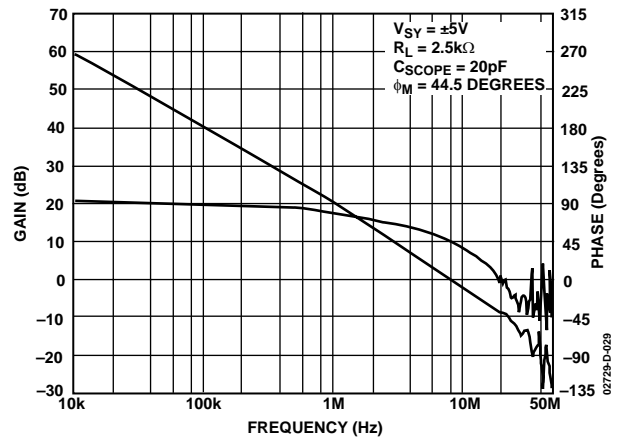

Figure 29. Open-Loop Gain and Phase vs. Frequency

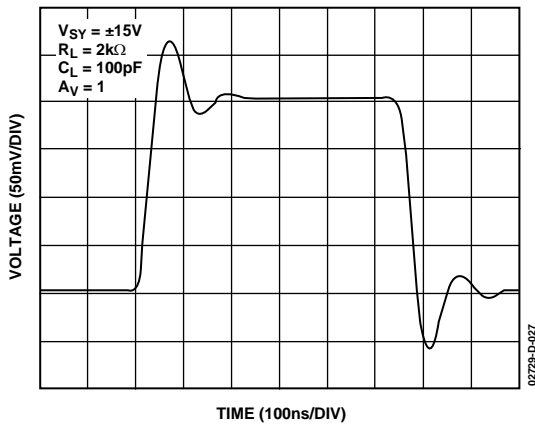

Figure 27. Small Signal Transient Response

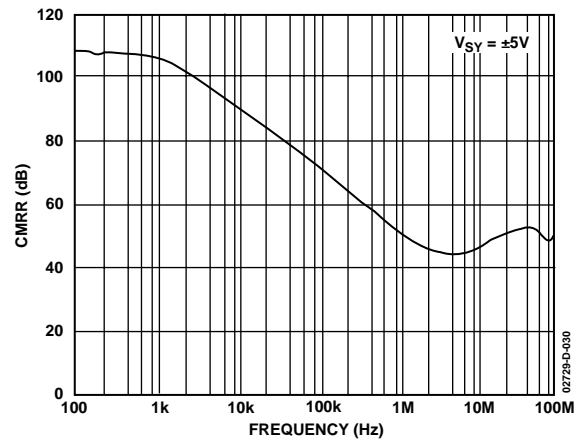

Figure 30. CMRR vs. Frequency

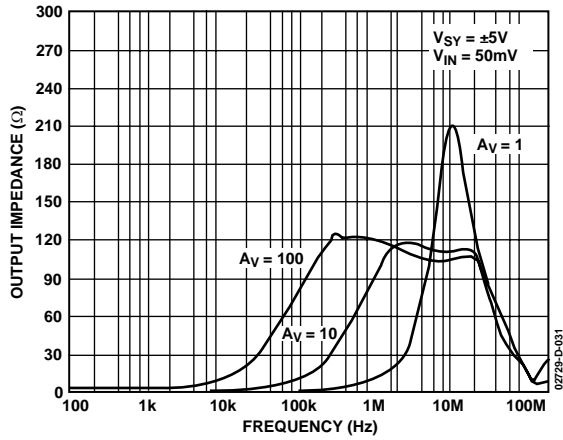

Figure 31. Output Impedance vs. Frequency

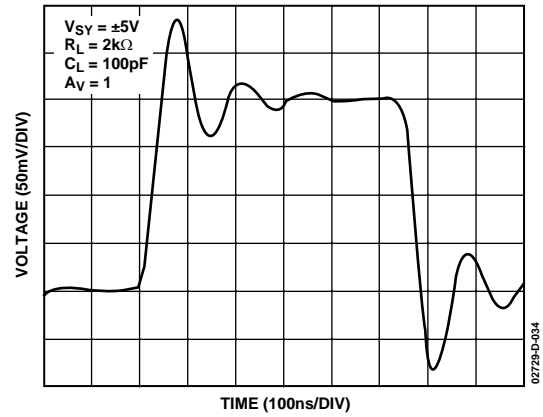

Figure 34. Small Signal Transient Response

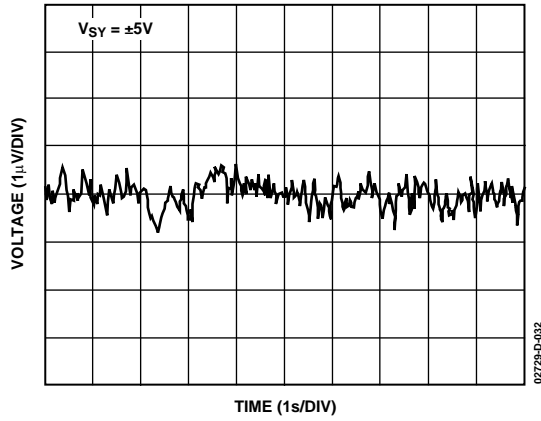

Figure 32. 0.1 Hz to 10 Hz Input Voltage Noise

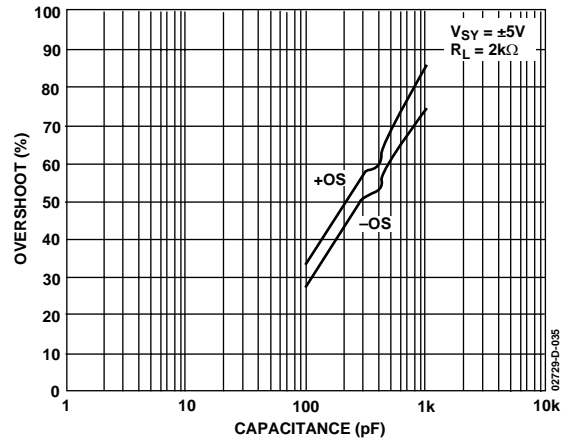

Figure 35. Small Signal Overshoot vs. Load Capacitance

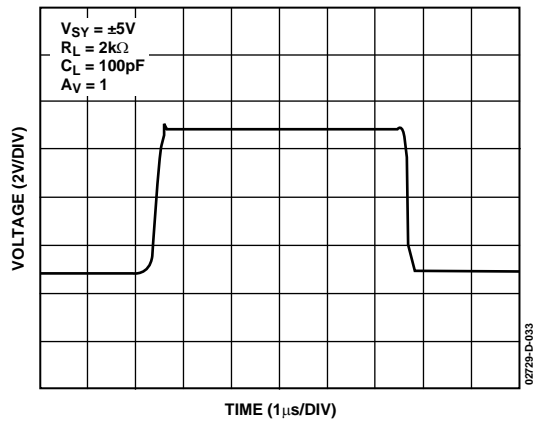

Figure 33. Large Signal Transient Response

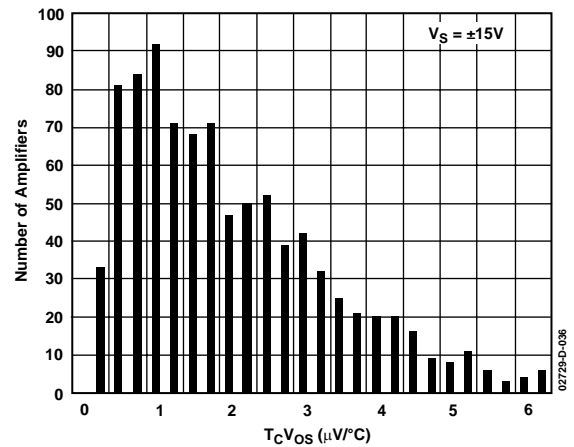

Figure 36. AD8513 T_cV_{os} Distribution

AD8510/AD8512/AD8513

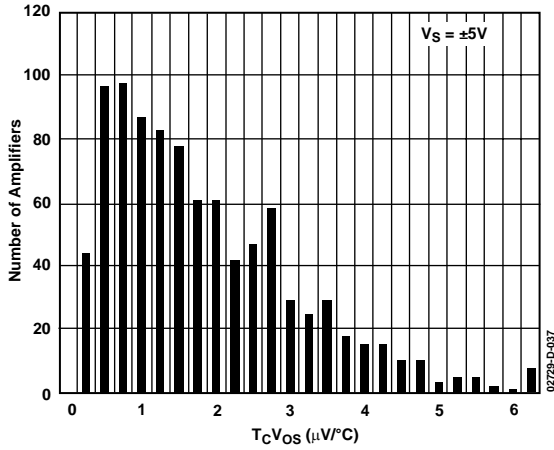

Figure 37. AD8513 TcV_{os} Distribution

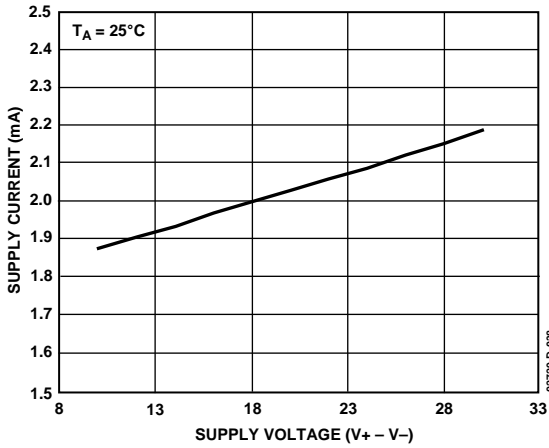

Figure 38. AD8513 Supply Current vs. Supply Voltage

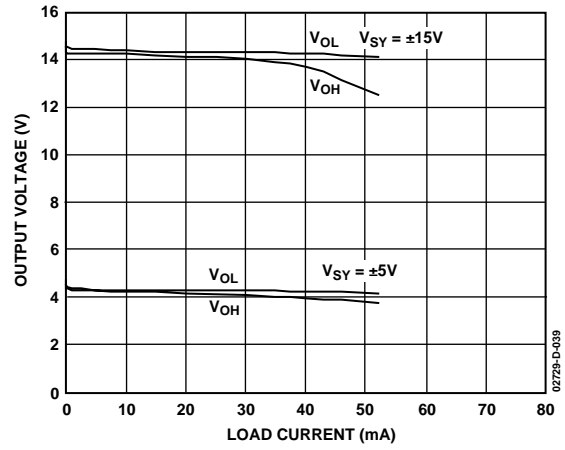

Figure 39. AD8513 Output Voltage vs. Load Current

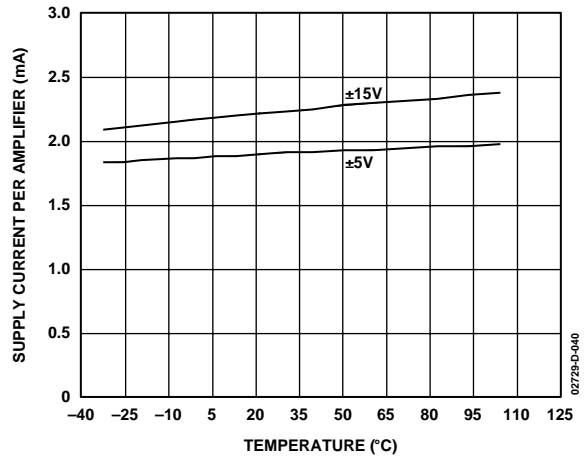

Figure 40. AD8513 Supply Current vs. Temperature

GENERAL APPLICATION INFORMATION

INPUT OVERVOLTAGE PROTECTION

The AD8510/AD8512/AD8513 have internal protective circuitry that allows voltages as high as 0.7 V beyond the supplies to be applied at the input of either terminal without causing damage. For higher input voltages, a series resistor is necessary to limit the input current. The resistor value can be determined from the formula

$$\frac{V_{IN} - V_S}{R_S} \leq 5mA$$

With a very low offset current of <0.5 nA up to 125°C, higher resistor values can be used in series with the inputs. A 5 kΩ resistor will protect the inputs to voltages as high as 25 V beyond the supplies and will add less than 10 μV to the offset.

OUTPUT PHASE REVERSAL

Phase reversal is a change of polarity in the transfer function of the amplifier. This can occur when the voltage applied at the input of an amplifier exceeds the maximum common-mode voltage.

Phase reversal can cause permanent damage to the device and may result in system lockups. The AD8510/AD8512/AD8513 do not exhibit phase reversal when input voltages are beyond the supplies.

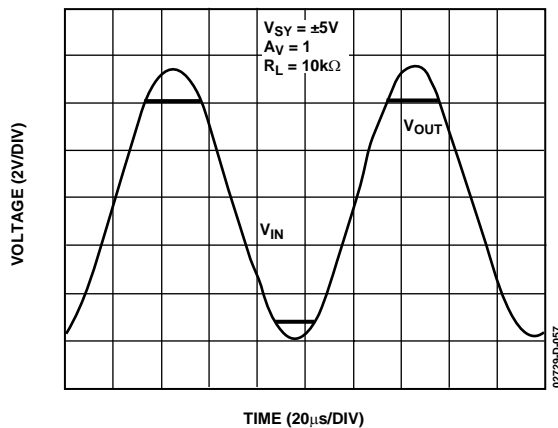

Figure 41. No Phase Reversal

THD + NOISE

The AD8510/AD8512/AD8513 have low total harmonic distortion and excellent gain linearity, making these amplifiers a great choice for precision circuits with high closed-loop gain, and for audio application circuits. Figure 42 shows that the AD8510/AD8512/AD8513 have approximately 0.0005% of total distortion when configured in positive unity gain (the worst case) and driving a 100 kΩ load.

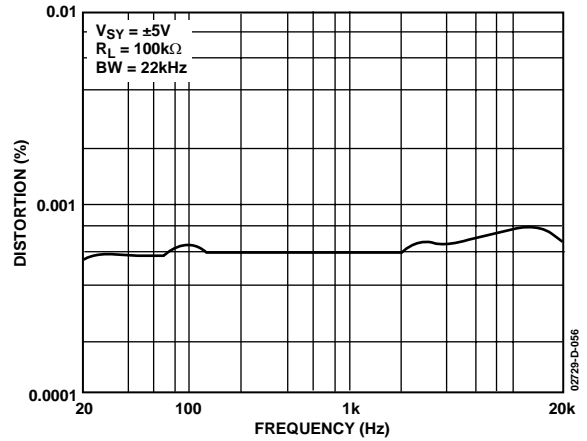

Figure 42. THD + N vs. Frequency

TOTAL NOISE INCLUDING SOURCE RESISTORS

The low input current noise and input bias current of the AD8510/AD8512/AD8513 make them the ideal amplifiers for circuits with substantial input source resistance. Input offset voltage increases by less than 15 nV per 500 Ω of source resistance at room temperature. The total noise density of the circuit is

$$e_{nTOTAL} = \sqrt{e_n^2 + (i_n R_S)^2 + 4kTR_S}$$

where:

e_n is the input voltage noise density of the parts.

i_n is the input current noise density of the parts.

R_S is the source resistance at the noninverting terminal.

k is Boltzman's constant (1.38×10^{-23} J/K).

T is the ambient temperature in Kelvin ($T = 273 + ^\circ C$).

For $R_S < 3.9$ kΩ, e_n dominates and $e_{nTOTAL} \approx e_n$.

The current noise of the AD8510/AD8512/AD8513 is so low that its total density does not become a significant term unless R_S is greater than 165 MΩ, an impractical value for most applications.

The total equivalent rms noise over a specific bandwidth is expressed as

$$e_{nTOTAL} = e_{nTOTAL} \sqrt{BW}$$

where BW is the bandwidth in Hertz.

Note that the above analysis is valid for frequencies larger than 150 Hz and assumes flat noise above 10 kHz. For lower frequencies, flicker noise (1/f) must be considered.

AD8510/AD8512/AD8513

SETTLING TIME

Settling time is the time it takes the output of the amplifier to reach and remain within a percentage of its final value after a pulse has been applied at the input. The AD8510/AD8512/AD8513 settle to within 0.01% in less than 900 ns with a step of 0 V to 10 V in unity gain. This makes each of the parts an excellent choice as a buffer at the output of DACs whose settling time is typically less than 1 μ s.

In addition to their fast settling time and fast slew rate, the AD8510/AD8512/AD8513's low offset voltage drift and input offset current maintain full accuracy of 12-bit converters over the entire operating temperature range.

OVERLOAD RECOVERY TIME

Overload recovery, also known as overdrive recovery, is the time it takes the output of an amplifier to recover from a saturated condition to its linear region. This recovery time is particularly important in applications where the amplifier must amplify small signals in the presence of large transient voltages.

Figure 43 shows the positive overload recovery of the AD8510/AD8512/AD8513. The output recovers in approximately 200 ns from a saturated condition.

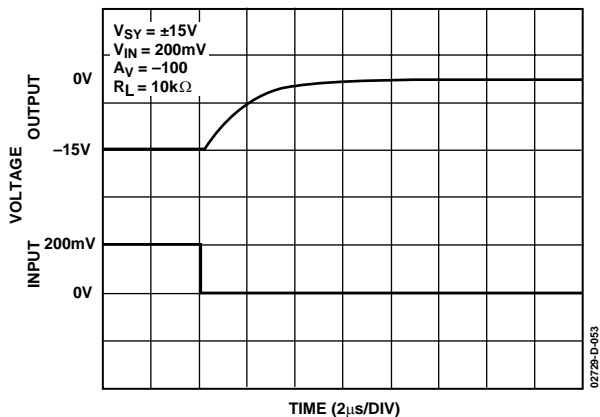

Figure 43. Positive Overload Recovery

The negative overdrive recovery time shown in Figure 44 is less than 200 ns.

In addition to the fast recovery time, the AD8510/AD8512/AD8513 show excellent symmetry of the positive and negative recovery times. This is an important feature for transient signal rectification, because the output signal is kept equally undistorted throughout any given period.

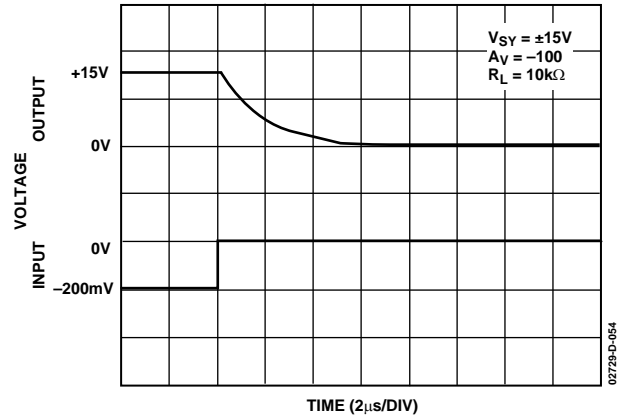

Figure 44. Negative Overload Recovery

CAPACITIVE LOAD DRIVE

The AD8510/AD8512/AD8513 are unconditionally stable at all gains in inverting and noninverting configurations. They are capable of driving up to 1000 pF of capacitive loads without oscillation in unity gain, the worst-case configuration.

However, as with most amplifiers, driving larger capacitive loads in a unity gain configuration may cause excessive overshoot and ringing or even oscillation. A simple snubber network reduces the amount of overshoot and ringing significantly. The advantage of this configuration is that the output swing of the amplifier is not reduced, because R_s is outside the feedback loop.

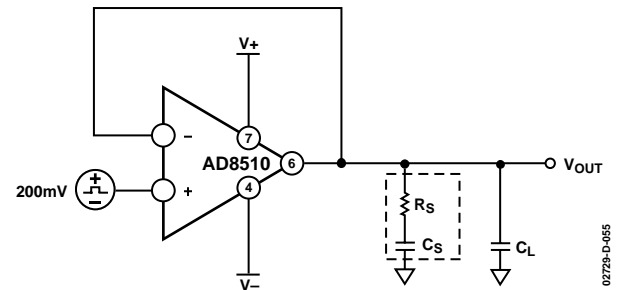

Figure 45. Snubber Network Configuration

Figure 46 shows a scope photograph of the output of the AD8510/AD8512/AD8513 in response to a 400 mV pulse. The circuit is configured in positive unity gain (worst-case) with a load experience of 500 pF.

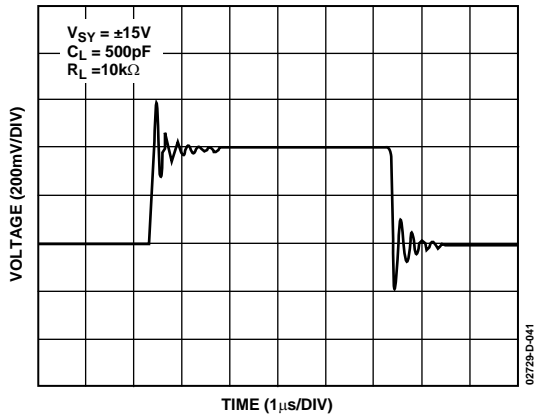

Figure 46. Capacitive Load Drive without Snubber

When the snubber circuit is used, the overshoot is reduced from 55% to less than 3% with the same load capacitance. Ringing is virtually eliminated, as shown in Figure 47.

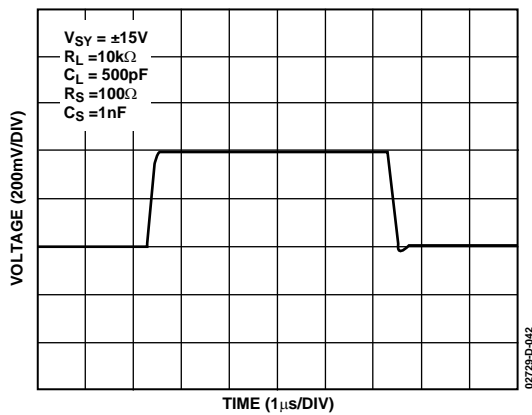

Figure 47. Capacitive Load with Snubber Network

Optimum values for R_s and C_s depend on the load capacitance and input stray capacitance and are determined empirically. Table 5 shows a few values that can be used as starting points.

Table 5. Optimum Values for Capacitive Loads

C_{LOAD}	R_s (Ω)	C_s
500 pF	100	1 nF
2 nF	70	100 pF
5 nF	60	300 pF

OPEN-LOOP GAIN AND PHASE RESPONSE

In addition to their impressive low noise, low offset voltage, and offset current, the AD8510/AD8512/AD8513 have excellent loop gain and phase response even when driving large resistive and capacitive loads. They were compared to the OPA2132 under the same conditions. With a 2.5 k Ω load at the output, the AD8510/AD8512/AD8513 have more than 8 MHz of bandwidth and a phase margin of more than 52°.

The OPA2132, on the other hand, has only 4.5 MHz of bandwidth and 28° of phase margin under the same test conditions. Even with a 1 nF capacitive load in parallel with the 2 k Ω load at the output, the AD8510/AD8512/AD8513 show much better response than the OPA2132, whose phase margin is degraded to less than 0, indicating oscillation.

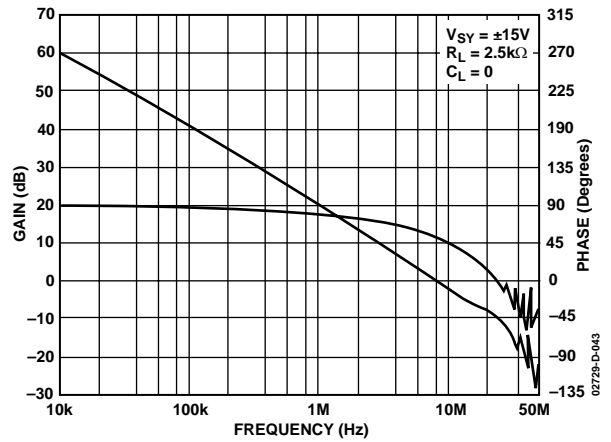

Figure 48. Frequency Response of the AD8510/AD8512/AD8513

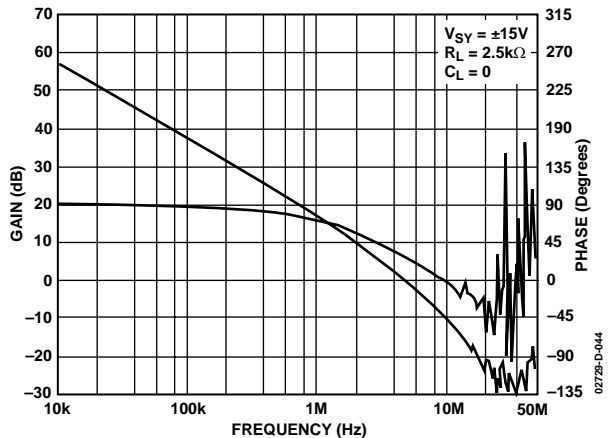

Figure 49. Frequency Response of the OPA2132

PRECISION RECTIFIERS

Rectifying circuits are used in a multitude of applications. One of the most popular uses is in the design of regulated power supplies, where a rectifier circuit is used to convert an input sinusoid to a unipolar output voltage. There are some potential problems for amplifiers used in this manner.

When the input voltage (V_{IN}) is negative, the output is zero. The magnitude of V_{IN} is doubled at the inputs of the op amp. This voltage can exceed the power supply voltage, which would damage some amplifiers permanently. The op amp must come out of saturation when V_{IN} is negative. This delays the output signal because the amplifier requires time to enter its linear region.

The AD8510/AD8512/AD8513 have a very fast overdrive recovery time, which makes them great choices for the rectification of transient signals. The symmetry of the positive and negative recovery times is also important in keeping the output signal undistorted.

Figure 50 shows the test circuit of the rectifier. The first stage of the circuit is a half-wave rectifier. When the sine wave applied at the input is positive, the output follows the input response. During the negative cycle of the input, the output tries to swing negative to follow the input, but the power supply restrains it to zero. In a similar fashion, the second stage is a follower during the positive cycle of the sine wave and an inverter during the negative cycle.

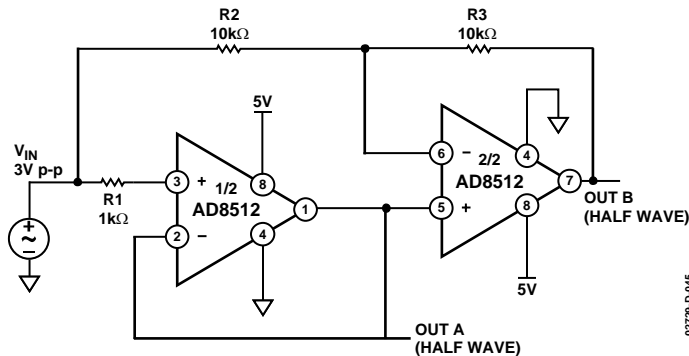

Figure 50. Half-Wave and Full-Wave Rectifier

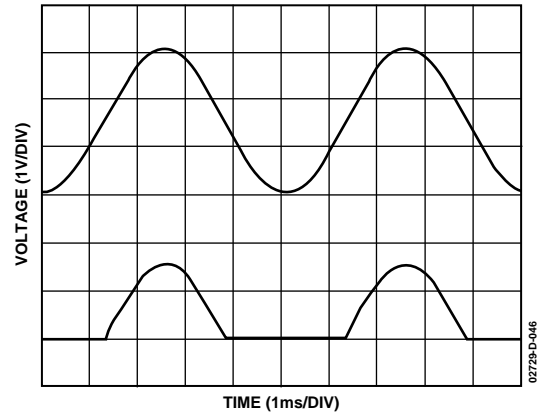

Figure 51. Half-Wave Rectifier Signal (Out A)

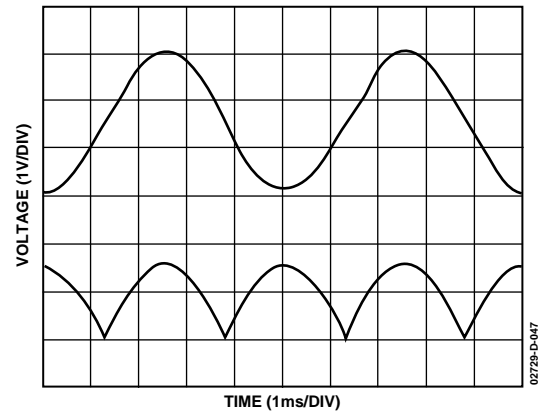

Figure 52. Full-Wave Rectifier Signal (Out B)

I-V CONVERSION APPLICATIONS

Photodiode Circuits

Common applications for I-V conversion include photodiode circuits, where the amplifier is used to convert a current emitted by a diode placed at the positive input terminal into an output voltage.

The AD8510/AD8512/AD8513's low input bias current, wide bandwidth, and low noise make them each an excellent choice for various photodiode applications, including fax machines, fiber optic controls, motion sensors, and bar code readers.

The circuit shown in Figure 53 uses a silicon diode with zero bias voltage. This is known as a Photovoltaic Mode; this configuration limits the overall noise and is suitable for instrumentation applications.

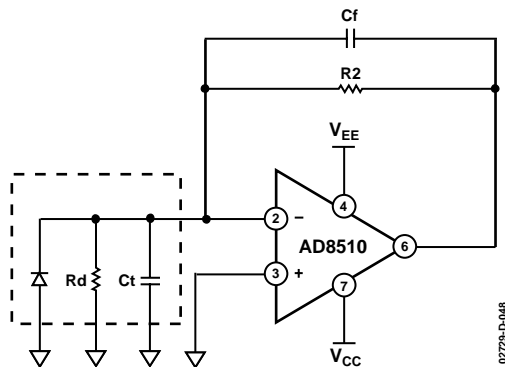

Figure 53. Equivalent Preamplifier Photodiode Circuit

A larger signal bandwidth can be attained at the expense of additional output noise. The total input capacitance (C_t) consists of the sum of the diode capacitance (typically 3 pF to 4 pF) and the amplifier's input capacitance (12 pF), which

includes external parasitic capacitance. C_t creates a pole in the frequency response, which may lead to an unstable system. To ensure stability and optimize the bandwidth of the signal, a capacitor is placed in the feedback loop of the circuit shown in Figure 53. It creates a zero and yields a bandwidth whose corner frequency is $1/(2\pi(R_2C_f))$.

The value of R_2 can be determined by the ratio V/I_D , where V is the desired output voltage of the op amp and I_D is the diode current. For example, if I_D is 100 μA and a 10 V output voltage is desired, R_2 should be 100 k Ω . R_d is a junction resistance that drops typically by a factor of 2 for every 10°C increase in temperature. A typical value for R_d is 1000 M Ω . Since $R_d \gg R_2$, the circuit behavior is not impacted by the effect of the junction resistance. The maximum signal bandwidth is

$$f_{MAX} = \sqrt{\frac{f_t}{2\pi R_2 C_t}}$$

where f_t is the unity gain frequency of the amplifier.

Using the parameters above, $C_f \approx 1$ pF, which yields a signal bandwidth of about 2.6 MHz.

$$C_f = \sqrt{\frac{C_t}{2\pi R_2 f_t}}$$

where f_t is the unity gain frequency of the op amp, achieves a phase margin, Φ_m , of approximately 45°.

A higher phase margin can be obtained by increasing the value of C_f . Setting C_f to twice the previous value yields approximately $\Phi_m = 65^\circ$ and a maximally flat frequency response, but reduces the maximum signal bandwidth by 50%.

AD8510/AD8512/AD8513

Signal Transmission Applications

One popular signal transmission method uses pulse-width modulation. High data rates may require a fast comparator rather than an op amp. However, the need for sharp and undistorted signals may favor using a linear amplifier.

The AD8510/AD8512/AD8513 make excellent voltage comparators. In addition to a high slew rate, the AD8510/AD8512/AD8513 have a very fast saturation recovery time. In the absence of feedback, the amplifiers are in open-loop mode (very high gain). In this mode of operation, they spend much of their time in saturation.

The circuit in Figure 54 compares two signals of different frequencies, namely a 100 Hz sine wave and a 1 kHz triangular wave. Figure 56 shows a scope photograph of the output waveform. A pull-up resistor (typically 5 kΩ) may be connected from the output to V_{CC} if the output voltage needs to reach the positive rail. The trade-off is that power consumption will be higher.

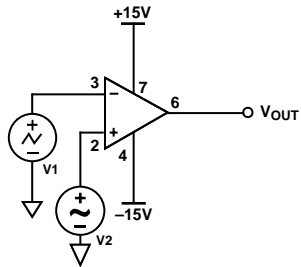

Figure 54. Pulse-Width Modulator

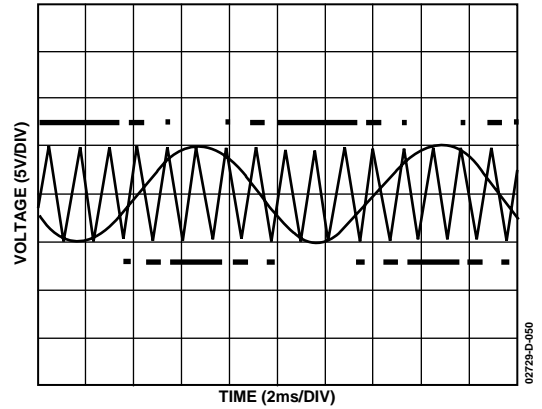

Figure 56. Pulse-Width Modulation

Crosstalk

Crosstalk, also known as channel separation, is a measure of signal feedthrough from one channel to the other on the same IC. The AD8512/AD8513 have a channel separation better than -90 dB for frequencies up to 10 kHz, and better than -50 dB for frequencies up to 10 MHz. Figure 57 shows the typical channel separation behavior between amplifier A (driving amplifier), with respect to amplifiers B, C, and D.

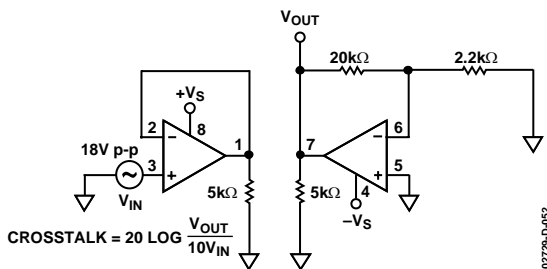

Figure 55. Crosstalk Test Circuit

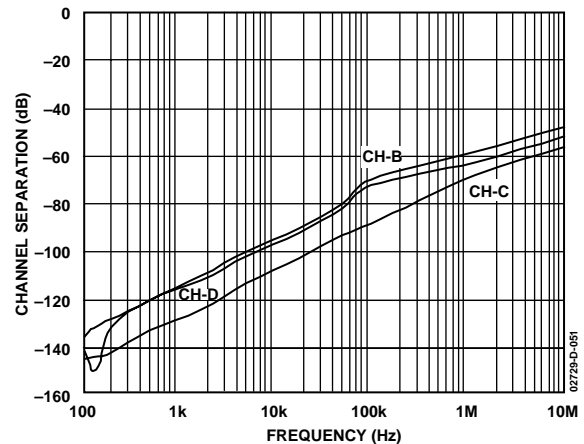
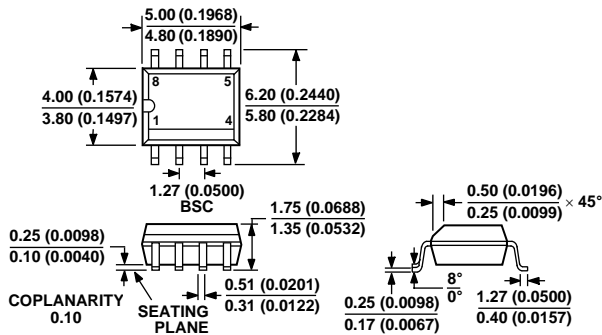

Figure 57. Channel Separation

OUTLINE DIMENSIONS



COMPLIANT TO JEDEC STANDARDS MS-012AA
 CONTROLLING DIMENSIONS ARE IN MILLIMETERS; INCH DIMENSIONS
 (IN PARENTHESES) ARE ROUNDED-OFF MILLIMETER EQUIVALENTS FOR
 REFERENCE ONLY AND ARE NOT APPROPRIATE FOR USE IN DESIGN

Figure 58. 8-Lead Standard Small Outline Package [SOIC]
 Narrow Body (R-8)
 Dimensions shown in millimeters and (inches)

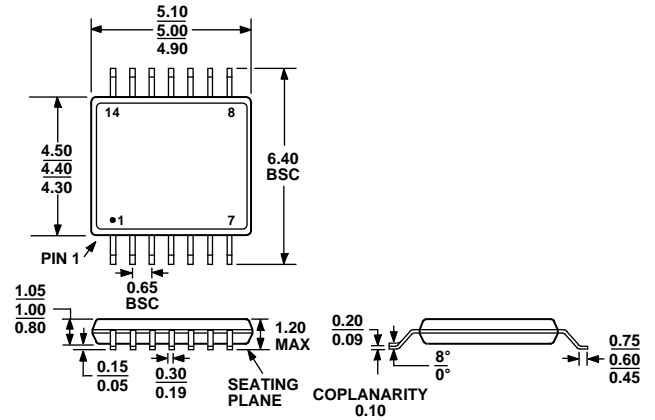

COMPLIANT TO JEDEC STANDARDS MO-153AB-1

Figure 60. 14-Lead Thin Shrink Small Outline Package [TSSOP]
 (RU-14)
 Dimensions show in millimeters

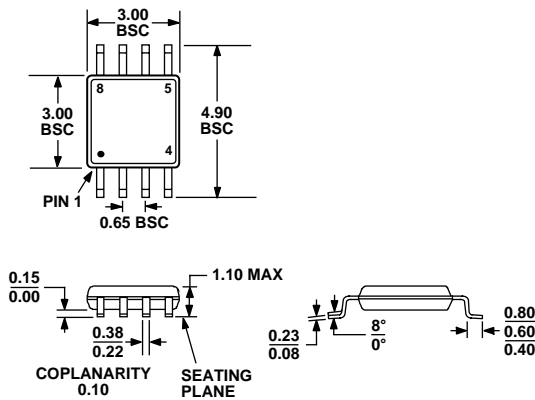

COMPLIANT TO JEDEC STANDARDS MO-187AA

Figure 59. 8-Lead Mini Small Outline Package [MSOP]
 (RM-8)
 Dimensions shown in millimeters

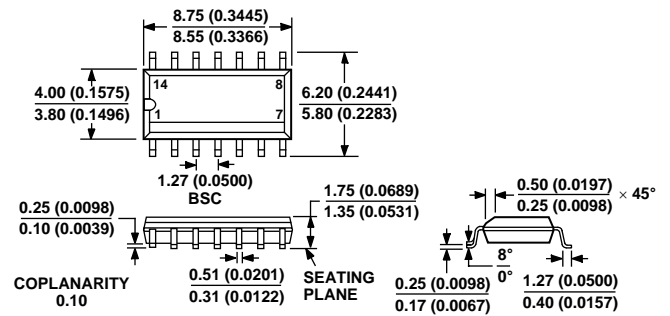

COMPLIANT TO JEDEC STANDARDS MS-012AB
 CONTROLLING DIMENSIONS ARE IN MILLIMETERS; INCH DIMENSIONS
 (IN PARENTHESES) ARE ROUNDED-OFF MILLIMETER EQUIVALENTS FOR
 REFERENCE ONLY AND ARE NOT APPROPRIATE FOR USE IN DESIGN

Figure 61. 14-Lead Standard Small Outline Package [SOIC]
 Narrow Body (R-14)
 Dimensions shown in millimeters and (inches)

AD8510/AD8512/AD8513

ORDERING GUIDE

Model	Temperature Range	Package Description	Package Option	Branding Information
AD8510ARM-REEL	-40°C to +125°C	8-Lead MSOP	RM-8	B7A
AD8510ARM-R2	-40°C to +125°C	8-Lead MSOP	RM-8	B7A
AD8510AR	-40°C to +125°C	8-Lead SOIC	R-8	
AD8510AR-REEL	-40°C to +125°C	8-Lead SOIC	R-8	
AD8510AR-REEL7	-40°C to +125°C	8-Lead SOIC	R-8	
AD8510ARZ ¹	-40°C to +125°C	8-Lead SOIC	R-8	
AD8510ARZ-REEL ¹	-40°C to +125°C	8-Lead SOIC	R-8	
AD8510ARZ-REEL7 ¹	-40°C to +125°C	8-Lead SOIC	R-8	
AD8510BR	-40°C to +125°C	8-Lead SOIC	R-8	
AD8510BR-REEL	-40°C to +125°C	8-Lead SOIC	R-8	
AD8510BR-REEL7	-40°C to +125°C	8-Lead SOIC	R-8	
AD8512ARM-REEL	-40°C to +125°C	8-Lead MSOP	RM-8	B8A
AD8512ARM-R2	-40°C to +125°C	8-Lead MSOP	RM-8	B8A
AD8512ARMZ-REEL ¹	-40°C to +125°C	8-Lead MSOP	RM-8	B8A
AD8512ARMZ-R2 ¹	-40°C to +125°C	8-Lead MSOP	RM-8	B8A
AD8512AR	-40°C to +125°C	8-Lead SOIC	R-8	
AD8512AR-REEL	-40°C to +125°C	8-Lead SOIC	R-8	
AD8512AR-REEL7	-40°C to +125°C	8-Lead SOIC	R-8	
AD8512ARZ ¹	-40°C to +125°C	8-Lead SOIC	R-8	
AD8512ARZ-REEL ¹	-40°C to +125°C	8-Lead SOIC	R-8	
AD8512ARZ-REEL7 ¹	-40°C to +125°C	8-Lead SOIC	R-8	
AD8512BR	-40°C to +125°C	8-Lead SOIC	R-8	
AD8512BR-REEL	-40°C to +125°C	8-Lead SOIC	R-8	
AD8512BR-REEL7	-40°C to +125°C	8-Lead SOIC	R-8	
AD8513AR	-40°C to +125°C	14-Lead SOIC	R-14	
AD8513AR-REEL	-40°C to +125°C	14-Lead SOIC	R-14	
AD8513AR-REEL7	-40°C to +125°C	14-Lead SOIC	R-14	
AD8513ARU	-40°C to +125°C	14-Lead TSSOP	RU-14	
AD8513ARU-REEL	-40°C to +125°C	14-Lead TSSOP	RU-14	

¹ Z = Pb-free part.