

HIGH FREQUENCY HIGH-SIDE AND LOW-SIDE GATE DRIVER IN U-DFN3030-10
Description

The DGD05473 is a high-frequency gate driver capable of driving N-channel MOSFETs. The floating high-side driver is rated up to 50V.

The DGD05473 logic inputs are compatible with standard TTL and CMOS levels (down to 3.3V) to interface easily with MCUs. UVLO for high-side and low-side protects a MOSFET with loss of supply. To protect MOSFETs, cross conduction prevention logic prevents the HO and LO outputs from being on at the same time.

Fast and well-matched propagation delays allow a higher switching frequency, enabling a smaller, more compact power switching design, using smaller associated components. To minimize space an internal bootstrap diode is included. The DGD05473 is offered in the U-DFN3030-10 package and operates over an extended -40°C to +125°C temperature range.

Applications

- DC-DC Converters
- Motor Controls
- Battery Powered Hand Tools
- eCig Devices
- Class D Power Amplifiers

Features

- 50V Floating High-Side Driver
- Drives Two N-Channel MOSFETs in a Half-Bridge Configuration
- 1.5A Source / 2.5A Sink Output Current Capability
- Internal Bootstrap Diode Included
- Undervoltage Lockout for High-Side and Low-Side Drivers
- Delay Matching Maximum of 5ns
- Propagation Delay Typical of 20ns
- Logic Input (HIN, LIN and EN) 3.3V Capability
- Ultra Low Standby Currents (<1µA)
- Extended Temperature Range: -40°C to +125°C
- **Totally Lead-Free & Fully RoHS Compliant (Notes 1 & 2)**
- **Halogen and Antimony Free. "Green" Device (Note 3)**
- **Qualified to AEC-Q100 Standards for High Reliability**
- **PPAP Capable (Note 4)**

Mechanical Data

- Case: U-DFN3030-10
- Case Material: Molded Plastic. "Green" Molding Compound
- UL Flammability Classification Rating 94V-0
- Moisture Sensitivity: Level 3 per J-STD-020
- Terminals: Finish—NiPdAu
- Solderable per MIL-STD-202, Method 208
- Weight: 0.017 grams (Approximate)

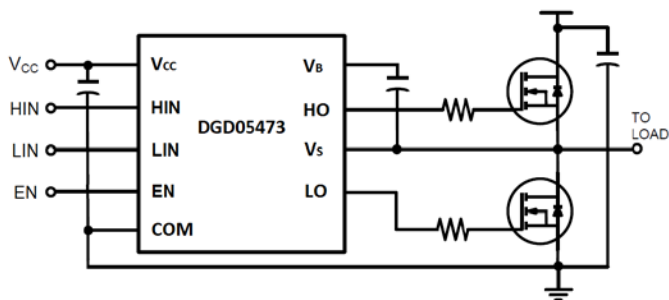

Typical Configuration



Top View

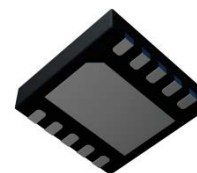

Bottom View

Ordering Information (Note 4 & 5)

| Product | Compliance | Marking | Reel Size (inches) | Tape Width (mm) | Quantity per Reel |
|---------------|------------|----------|--------------------|-----------------|-------------------|
| DGD05473FNQ-7 | Automotive | DGD05473 | 7 | 8 | 3000 |

- Notes:
1. No purposely added lead. Fully EU Directive 2002/95/EC (RoHS), 2011/65/EU (RoHS 2) & 2015/863/EU (RoHS 3) compliant.
 2. See <https://www.diodes.com/quality/lead-free/> for more information about Diodes Incorporated's definitions of Halogen- and Antimony-free, "Green" and Lead-free.
 3. Halogen- and Antimony-free "Green" products are defined as those which contain <900ppm bromine, <900ppm chlorine (<1500ppm total Br + Cl) and <1000ppm antimony compounds.
 4. Automotive products are AEC-Q101 qualified and are PPAP capable. Refer to http://www.diodes.com/quality/product_compliance_definitions/.
 5. For packaging details, go to our website at <https://www.diodes.com/design/support/packaging/diodes-packaging/>.

Marking Information

DGD05473 = Product Type Marking Code
 YY = Year (ex: 18 = 2018)
 WW = Week (01 to 53)

Pin Assignments

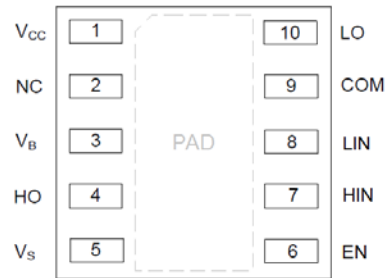

Top View: U-DFN3030-10

Pin Descriptions

| Pin Number | Pin Name | Function |
|------------|-----------------|---|
| 1 | V _{CC} | Low-Side and Logic Supply |
| 2 | NC | No connect (No Internal Connection) |
| 3 | V _B | High-Side Floating Supply |
| 4 | HO | High-Side Gate Drive Output |
| 5 | V _S | High-Side Floating Supply Return |
| 6 | EN | Logic Input Enable, a Logic Low turns off Gate Driver |
| 7 | HIN | Logic Input for High-Side Gate Driver, in Phase with HO |
| 8 | LIN | Logic Input for Low-Side Gate Driver, in Phase with LO |
| 9 | COM | Low-Side and Logic Return |
| 10 | LO | Low-Side Gate Drive Output |
| PAD | Substrate | Connect to COM on PCB |

Functional Block Diagram

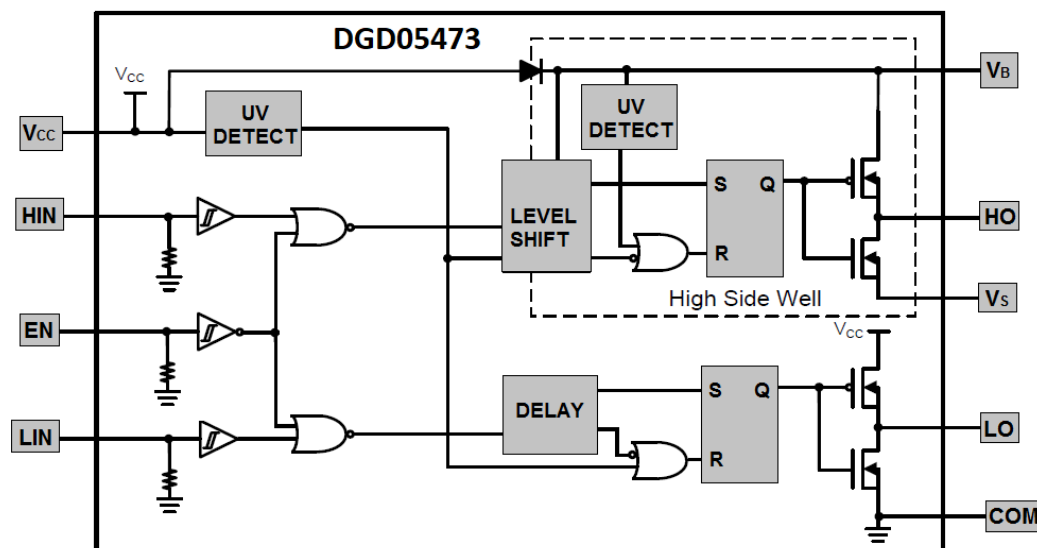

Absolute Maximum Ratings (@T_A = +25°C, unless otherwise specified.)

| Characteristic | Symbol | Value | Unit |
|--|----------------------|--|------|
| High-Side Floating Positive Supply Voltage | V _B | -0.3 to +60 | V |
| High-Side Floating Negative Supply Voltage | V _S | V _B -14 to V _B +0.3 | V |
| High-Side Floating Output Voltage | V _{HO} | V _S -0.3 to V _B +0.3 | V |
| Offset Supply Voltage Transient | dV _S / dt | 50 | V/ns |
| Logic and Low-Side Fixed Supply Voltage | V _{CC} | -0.3 to +14 | V |
| Low-Side Output Voltage | V _{LO} | -0.3 to V _{CC} +0.3 | V |
| Logic Input Voltage (HIN, LIN and EN) | V _{IN} | -0.3 to V _{CC} +0.3 | V |
| Bootstrap Diode Current (Pulsed <10μs) | I _{BD} | 1 | A |

Thermal Characteristics (@T_A = +25°C, unless otherwise specified.)

| Characteristic | Symbol | Value | Unit |
|---|------------------|-------------|------|
| Power Dissipation Linear Derating Factor (Note 5) | P _D | 0.4 | W |
| Thermal Resistance, Junction to Ambient (Note 5) | R _{θJA} | 64 | °C/W |
| Thermal Resistance, Junction to Case (Note 5) | R _{θJC} | 42 | °C/W |
| Operating Temperature | T _J | +150 | °C |
| Lead Temperature (Soldering, 10s) | T _L | +300 | |
| Storage Temperature Range | T _{STG} | -55 to +150 | |

Note: 5. When mounted on a standard JEDEC 2-layer FR-4 board.

Recommended Operating Conditions

| Parameter | Symbol | Min | Max | Unit |
|--|-----------------|----------------------|---------------------|------|
| High-Side Floating Supply | V _B | V _S + 4.4 | V _S + 14 | V |
| High-Side Floating Supply Offset Voltage | V _S | (Note 6) | 50 (Note 7) | V |
| High-Side Floating Output Voltage | V _{HO} | V _S | V _B | V |
| Logic and Low Side Fixed Supply Voltage | V _{CC} | 4.7 (Note 8) | 14 | V |
| Low-Side Output Voltage | V _{LO} | 0 | V _{CC} | V |
| Logic Input Voltage (HIN, LIN and EN) | V _{IN} | 0 | 5 | V |
| Ambient Temperature | T _A | -40 | +125 | °C |

Notes: 6. Logic operation for V_S of -5V to +50V.

7. Provided V_B doesn't exceed absolute maximum rating of 60V.

8. For operation of V_{CC} = 4.7V to 4.9V, an external bootstrap Schottky diode (0.3V V_{fd}, 1A) is necessary, see Figure 4. For operation V_{CC} ≥ 4.9V, the external Schottky diode is not required.

DC Electrical Characteristics ($V_{CC} = V_{BS} = 12V$, $COM = V_S = 0V$, $@T_A = +25^\circ C$, unless otherwise specified.) (Note 9)

| Parameter | Symbol | Min | Typ | Max | Unit | Conditions |
|---|---------------|-----|------|------|---------|---------------------------------------|
| Logic "1" Input Voltage | V_{IH} | 2.4 | — | — | V | — |
| Logic "0" Input Voltage | V_{IL} | — | — | 0.8 | V | — |
| Enable Logic "1" Input Voltage | V_{ENIH} | 1.6 | — | — | V | — |
| Enable Logic "0" Input Voltage | V_{ENIL} | — | — | 0.7 | V | — |
| Input Voltage Hysteresis | V_{INHYS} | — | 0.6 | — | V | — |
| Enable Input Voltage Hysteresis | $V_{ENINHYS}$ | — | 0.1 | — | V | — |
| High Level Output Voltage, $V_{BIAS} - V_O$ | V_{OH} | — | 0.45 | 0.6 | V | $I_{O+} = 100mA$ |
| Low Level Output Voltage, V_O | V_{OL} | — | 0.15 | 0.22 | V | $I_{O-} = 100mA$ |
| Offset Supply Leakage Current | I_{LK} | — | 1 | 5 | μA | $V_B = V_S = 60V$ |
| V_{CC} Shutdown Supply Current | I_{CCSD} | — | 0 | 1 | μA | $V_{IN} = 0V$ or $5V$, $V_{EN} = 0V$ |
| V_{CC} Quiescent Supply Current | I_{CCQ} | — | 130 | 200 | μA | $V_{IN} = 0V$ or $5V$ |
| V_{CC} Operating Supply Current | I_{CCOP} | — | 7.3 | — | mA | $f_s = 500kHz$, $C_L = 1000pF$ |
| V_{BS} Quiescent Supply Current | I_{BSQ} | — | 40 | 100 | μA | $V_{IN} = 0V$ or $5V$ |
| V_{BS} Operating Supply Current | I_{BSOP} | — | 7.3 | — | mA | $f_s = 500kHz$, $C_L = 1000pF$ |
| Logic "1" Input Bias Current | I_{IN+} | — | — | 50 | μA | $V_{IN} = 5V$ |
| Logic "0" Input Bias Current | I_{IN-} | — | — | 5 | μA | $V_{IN} = 0V$ |
| Enable Logic "1" Input Bias Current | I_{ENIN+} | — | 43 | 60 | μA | $V_{IN} = 5V$ |
| Enable Logic "0" Input Bias Current | I_{ENIN-} | — | 0 | 5 | μA | $V_{IN} = 0V$ |
| V_{BS} Supply Undervoltage Positive Going Threshold | V_{BSUV+} | 3.3 | 3.8 | 4.4 | V | — |
| V_{BS} Supply Undervoltage Negative Going Threshold | V_{BSUV-} | 2.9 | 3.3 | 3.9 | V | — |
| V_{CC} Supply Undervoltage Positive Going Threshold | V_{CCUV+} | 3.3 | 3.8 | 4.4 | V | — |
| V_{CC} Supply Undervoltage Negative Going Threshold | V_{CCUV-} | 2.9 | 3.3 | 3.9 | V | — |
| Output High Short Circuit Pulsed Current | I_{O+} | 1.0 | 1.5 | — | A | $V_O = 0V$, $PW \leq 10\mu s$ |
| Output Low Short Circuit Pulsed Current | I_{O-} | 1.9 | 2.5 | — | A | $V_O = 15V$, $PW \leq 10\mu s$ |
| Forward Voltage of Bootstrap Diode | V_{F1} | — | 0.67 | — | V | $I_F = 100\mu A$ |
| Forward Voltage of Bootstrap Diode | V_{F2} | — | 1.2 | — | V | $I_F = 100mA$ |

Note: 9. The V_{IN} and I_{IN} parameters are applicable to the logic pins: HIN, LIN and EN. The V_O and I_O parameters are applicable to the respective output pins: HO and LO.

AC Electrical Characteristics ($V_{CC} = V_{BS} = 12V$, $COM = V_S = 0V$, $C_L = 1000pF$, $@T_A = +25^\circ C$, unless otherwise specified.)

| Parameter | Symbol | Min | Typ | Max | Unit | Conditions |
|---------------------------------|-----------|-----|-----|-----|------|-------------|
| Turn-on Propagation Delay | t_{ON} | — | 20 | 35 | ns | — |
| Turn-off Propagation Delay | t_{OFF} | — | 23 | 56 | ns | $V_S = 50V$ |
| Delay Matching, HO & LO Turn-on | t_{DM} | — | — | 5 | ns | — |
| Turn-on Rise Time | t_r | — | 16 | 30 | ns | — |
| Turn-off Fall Time | t_f | — | 12 | 25 | ns | — |

Timing Waveforms

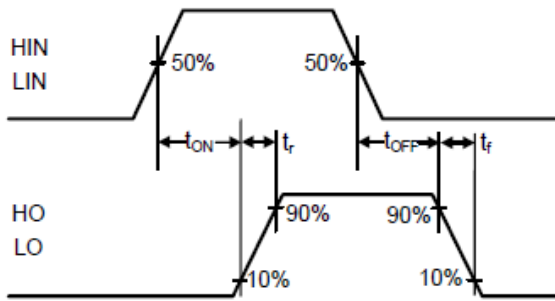

Figure 1. Switching Time Waveform Definitions

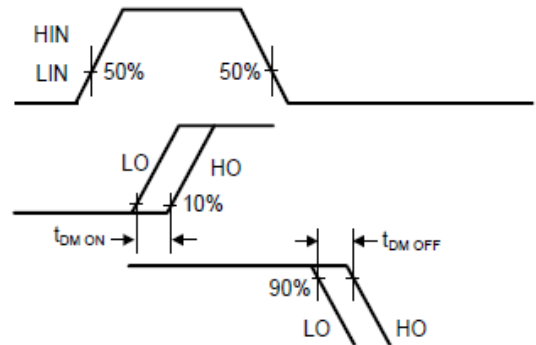

Figure 2. Delay Matching Waveform Definitions

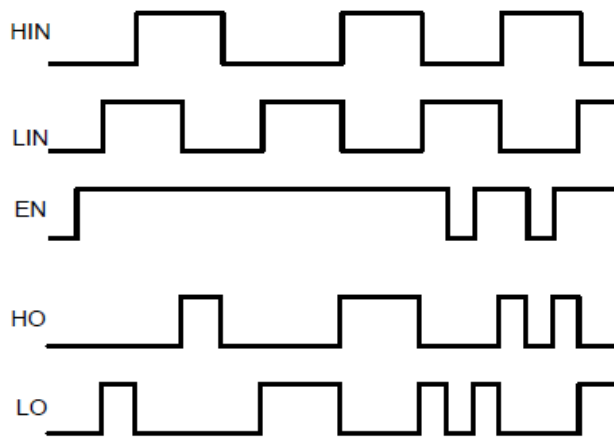

Figure 3. Input / Output Timing Diagram

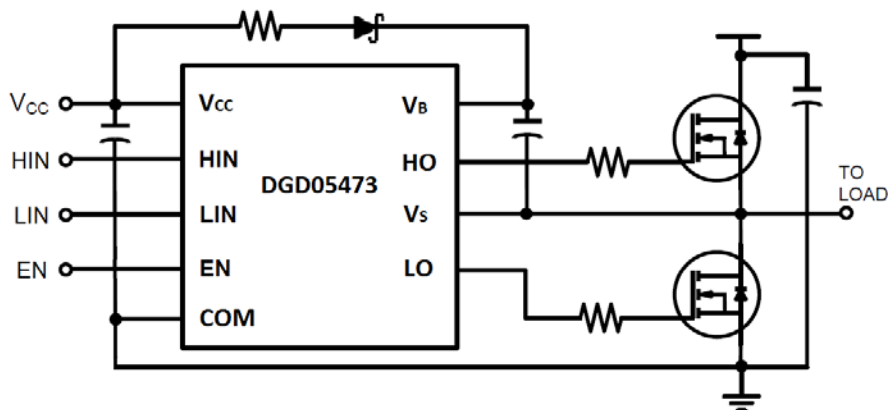

Figure 4. Typical application necessary for $V_{CC} = 4.7V$ to $4.9V$ operation. For $V_{CC} \geq 4.9V$, the bootstrap Schottky diode (0.3V Voltage drop, 1A) and resistor are not required.

Typical Performance Characteristics (@T_A = +25°C, unless otherwise specified.)

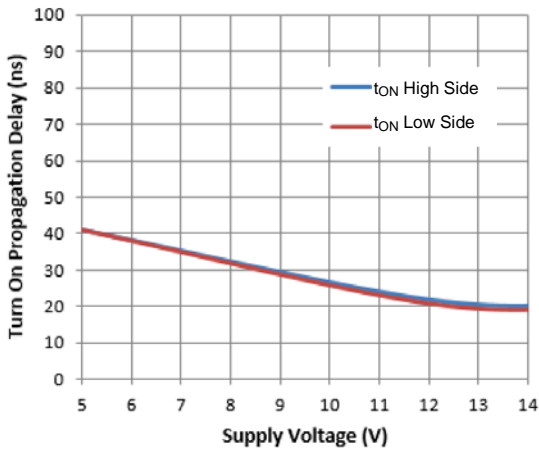

Figure 5. Turn-on Propagation Delay vs. Supply Voltage

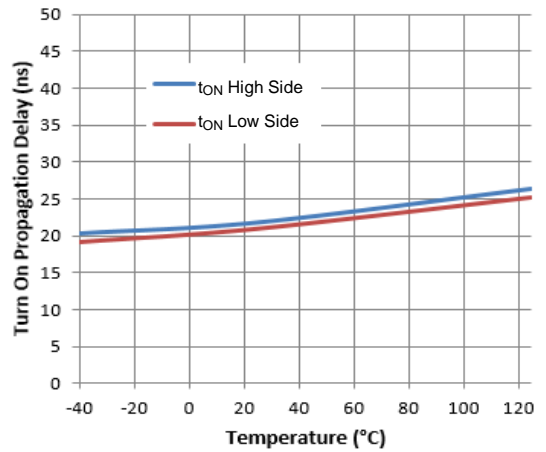

Figure 6. Turn-on Propagation Delay vs. Temperature

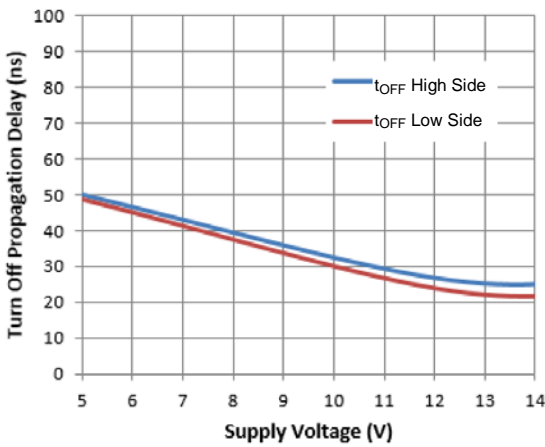

Figure 7. Turn-off Propagation Delay vs. Supply Voltage

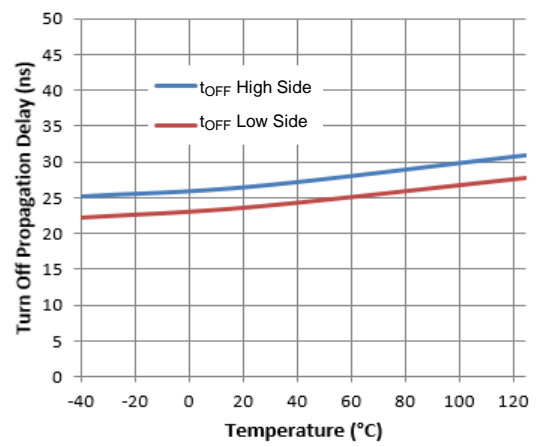

Figure 8. Turn-off Propagation Delay vs. Temperature

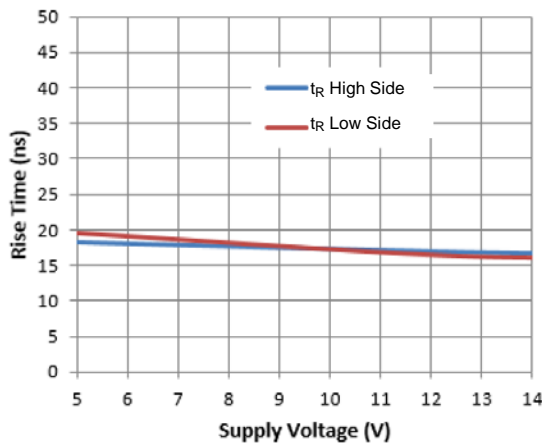

Figure 9. Rise Time vs. Supply Voltage

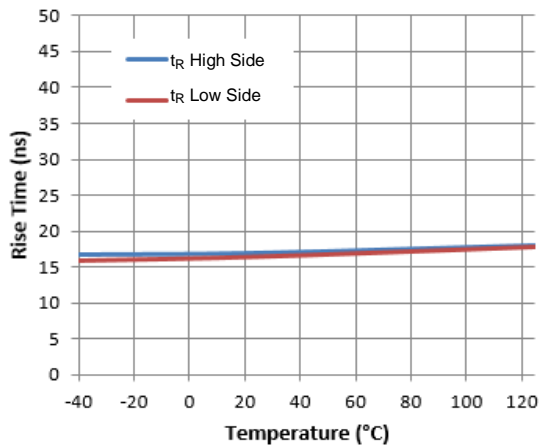

Figure 10. Rise Time vs. Temperature

Typical Performance Characteristics (continued)

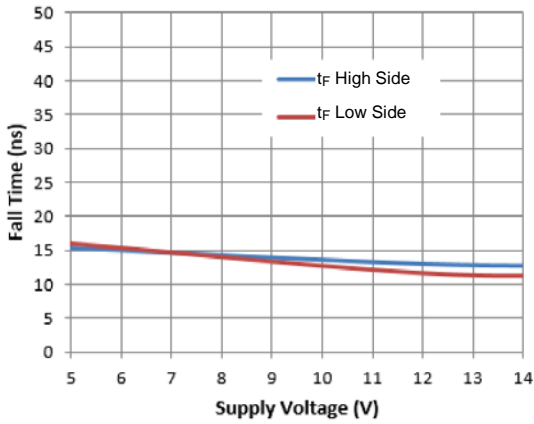

Figure 11. Fall Time vs. Supply Voltage

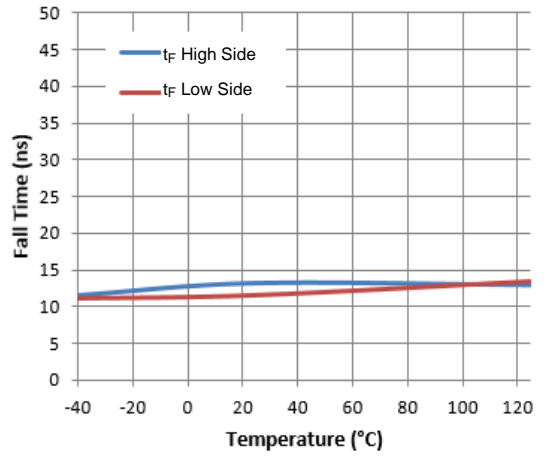

Figure 12. Fall Time vs. Temperature

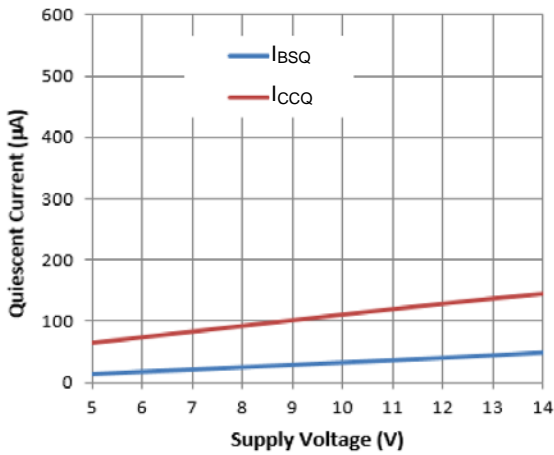

Figure 13. Quiescent Current vs. Supply Voltage

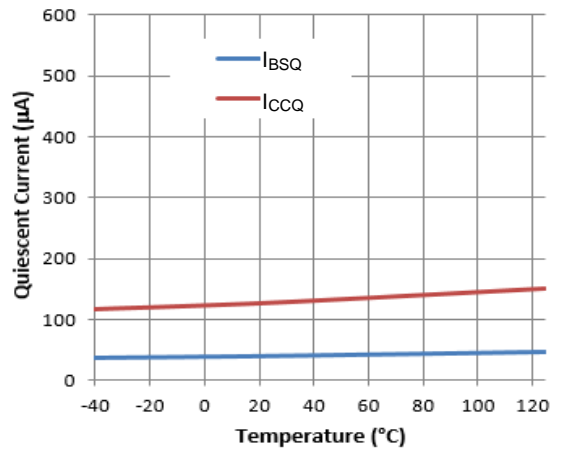

Figure 14. Quiescent Current vs. Temperature

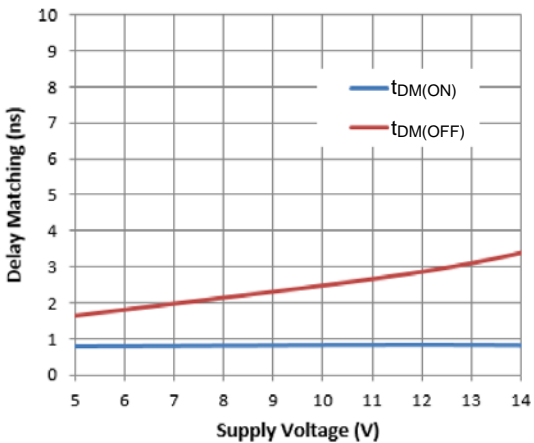

Figure 15. Delay Matching vs. Supply Voltage

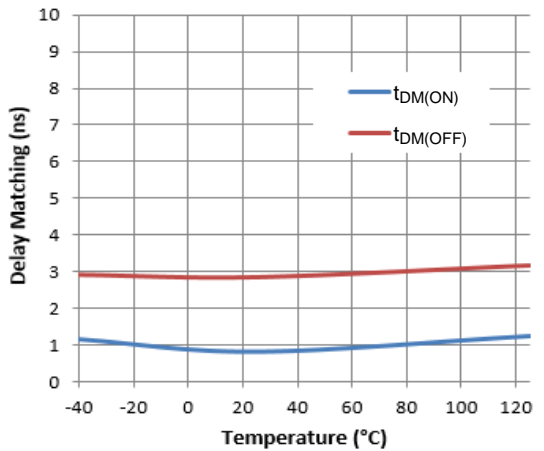

Figure 16. Delay Matching vs. Temperature

Typical Performance Characteristics (continued)

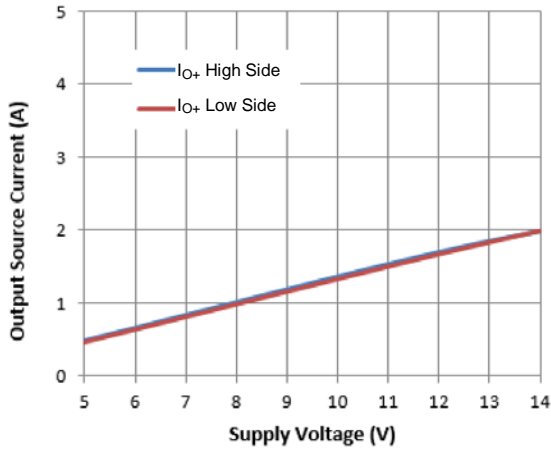

Figure 17. Output Source Current vs. Supply Voltage

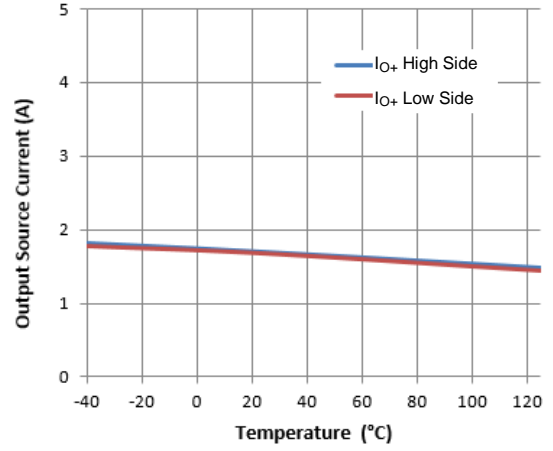

Figure 18. Output Source Current vs. Temperature

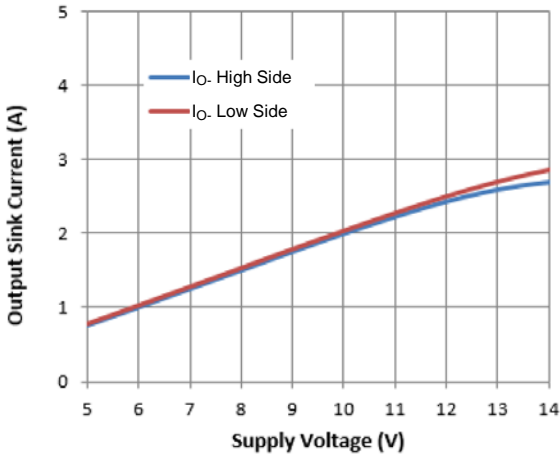

Figure 19. Output Sink Current vs. Supply Voltage

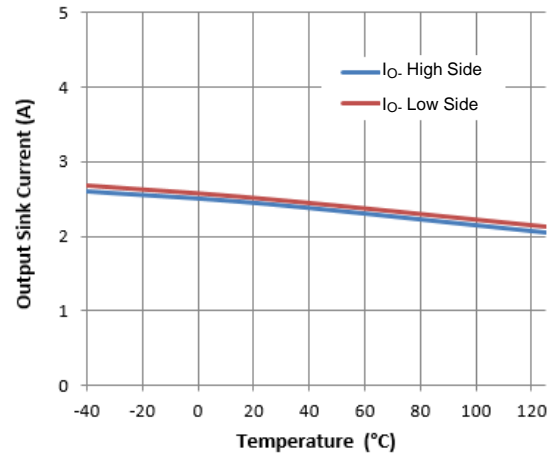

Figure 20. Output Sink Current vs. Temperature

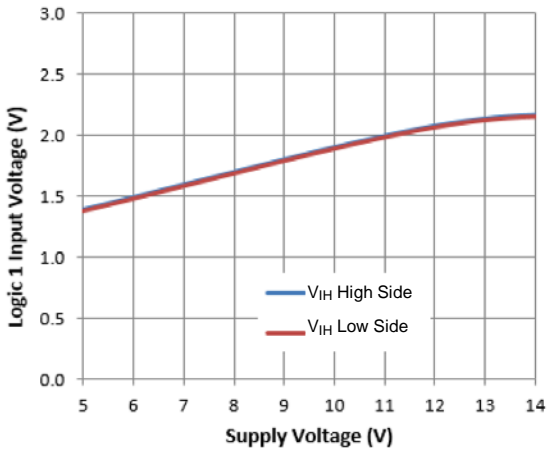

Figure 21. Logic 1 Input Voltage vs. Supply Voltage

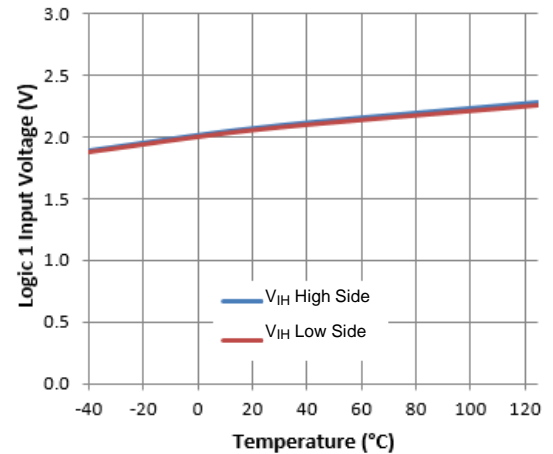

Figure 22. Logic 1 Input Voltage vs. Temperature

Typical Performance Characteristics (continued)

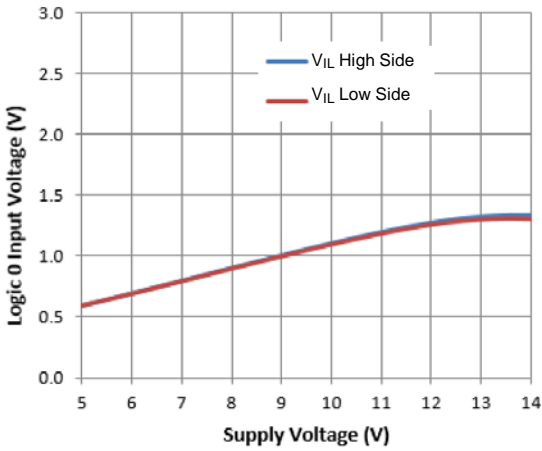

Figure 23. Logic 0 Input Voltage vs. Supply Voltage

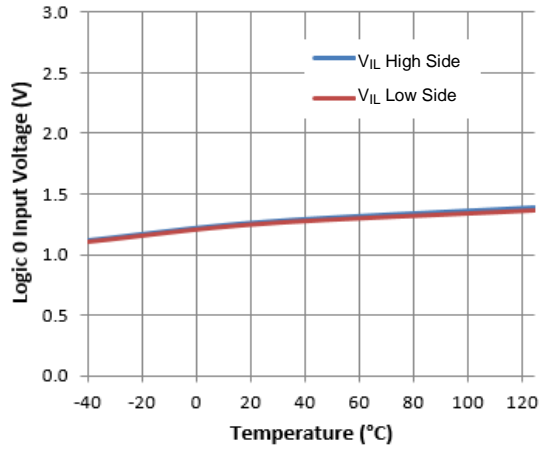

Figure 24. Logic 0 Input Voltage vs. Temperature

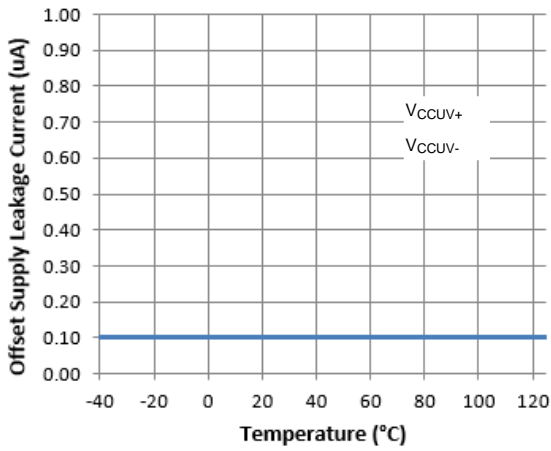
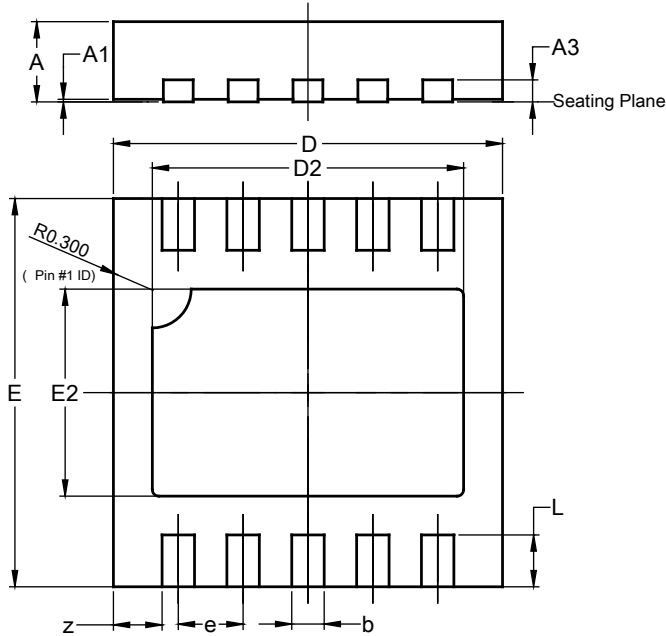

Figure 25. Offset Supply Leakage Current vs. Temperature

Package Outline Dimensions

Please see <http://www.diodes.com/package-outlines.html> for the latest version.

U-DFN3030-10



| U-DFN3030-10 | | | |
|----------------------|------|------|-------|
| Dim | Min | Max | Typ |
| A | 0.57 | 0.63 | 0.60 |
| A1 | 0.00 | 0.05 | 0.02 |
| A3 | — | — | 0.15 |
| b | 0.20 | 0.30 | 0.25 |
| D | 2.90 | 3.10 | 3.00 |
| D2 | 2.30 | 2.50 | 2.40 |
| E | 2.90 | 3.10 | 3.00 |
| E2 | 1.50 | 1.70 | 1.60 |
| e | — | — | 0.50 |
| L | 0.25 | 0.55 | 0.40 |
| z | — | — | 0.375 |
| All Dimensions in mm | | | |

Suggested Pad Layout

Please see <http://www.diodes.com/package-outlines.html> for the latest version.

U-DFN3030-10

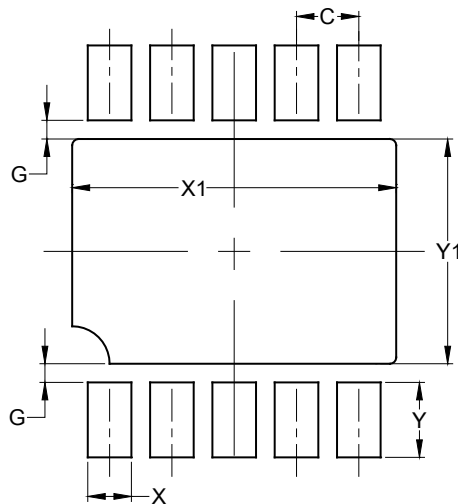

| Dimensions | Value (in mm) |
|------------|---------------|
| C | 0.50 |
| G | 0.15 |
| X | 0.35 |
| X1 | 2.60 |
| Y | 0.60 |
| Y1 | 1.80 |

IMPORTANT NOTICE

DIODES INCORPORATED MAKES NO WARRANTY OF ANY KIND, EXPRESS OR IMPLIED, WITH REGARDS TO THIS DOCUMENT, INCLUDING, BUT NOT LIMITED TO, THE IMPLIED WARRANTIES OF MERCHANTABILITY AND FITNESS FOR A PARTICULAR PURPOSE (AND THEIR EQUIVALENTS UNDER THE LAWS OF ANY JURISDICTION).

Diodes Incorporated and its subsidiaries reserve the right to make modifications, enhancements, improvements, corrections or other changes without further notice to this document and any product described herein. Diodes Incorporated does not assume any liability arising out of the application or use of this document or any product described herein; neither does Diodes Incorporated convey any license under its patent or trademark rights, nor the rights of others. Any Customer or user of this document or products described herein in such applications shall assume all risks of such use and will agree to hold Diodes Incorporated and all the companies whose products are represented on Diodes Incorporated website, harmless against all damages.

Diodes Incorporated does not warrant or accept any liability whatsoever in respect of any products purchased through unauthorized sales channel. Should Customers purchase or use Diodes Incorporated products for any unintended or unauthorized application, Customers shall indemnify and hold Diodes Incorporated and its representatives harmless against all claims, damages, expenses, and attorney fees arising out of, directly or indirectly, any claim of personal injury or death associated with such unintended or unauthorized application.

Products described herein may be covered by one or more United States, international or foreign patents pending. Product names and markings noted herein may also be covered by one or more United States, international or foreign trademarks.

This document is written in English but may be translated into multiple languages for reference. Only the English version of this document is the final and determinative format released by Diodes Incorporated.

LIFE SUPPORT

Diodes Incorporated products are specifically not authorized for use as critical components in life support devices or systems without the express written approval of the Chief Executive Officer of Diodes Incorporated. As used herein:

A. Life support devices or systems are devices or systems which:

1. are intended to implant into the body, or
2. support or sustain life and whose failure to perform when properly used in accordance with instructions for use provided in the labeling can be reasonably expected to result in significant injury to the user.

B. A critical component is any component in a life support device or system whose failure to perform can be reasonably expected to cause the failure of the life support device or to affect its safety or effectiveness.

Customers represent that they have all necessary expertise in the safety and regulatory ramifications of their life support devices or systems, and acknowledge and agree that they are solely responsible for all legal, regulatory and safety-related requirements concerning their products and any use of Diodes Incorporated products in such safety-critical, life support devices or systems, notwithstanding any devices- or systems-related information or support that may be provided by Diodes Incorporated. Further, Customers must fully indemnify Diodes Incorporated and its representatives against any damages arising out of the use of Diodes Incorporated products in such safety-critical, life support devices or systems.

Copyright © 2019, Diodes Incorporated

www.diodes.com