

SPECIFICATIONS

Contact Rating: As per individual switch
 Initial Contact Resistance: Less than 20 milliohms
 Insulation Resistance: 500VDC – 100 milliohms
 Dielectric Strength: 500V AC for 1 minute between any terminal and frame
 Operating Temperature: -20°C to +70°C (-4°F to +158°F)
 Soldering: Auto 270 ± 5°C/3 seconds; Manual 350 ± 10°C/3 seconds
 Life: 10,000 cycles minimum
 Timing: See individual specifications
 For special applications, contact factory

MATERIALS

Contact: Silver plated copper alloy

HOW TO ORDER

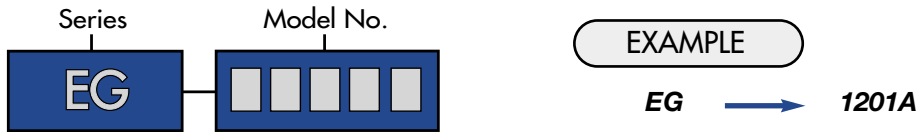

SPECIFICATIONS SUBJECT TO CHANGE WITHOUT NOTICE.

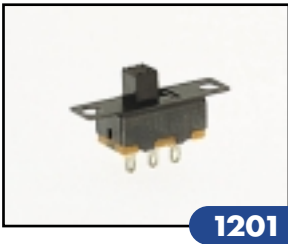

1201

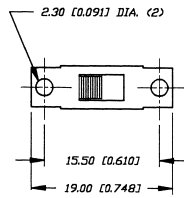

PANEL MOUNT

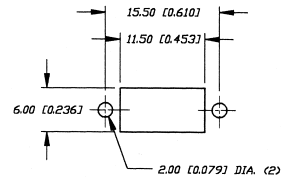

Model No.	L
EG1201	4
EG1201A	5.5

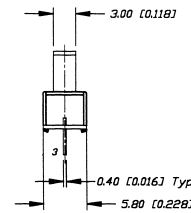
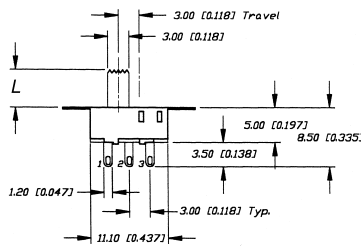

Schematic

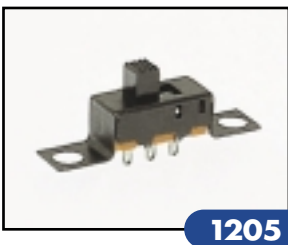
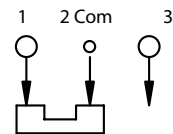

1205

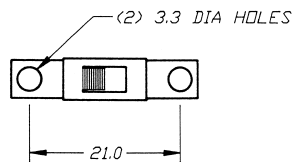

P.C. MOUNTING

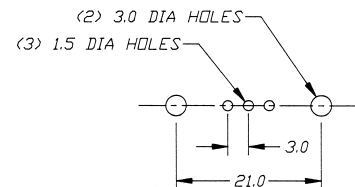

Model No.	L
EG1205	4
EG1205A	5.5

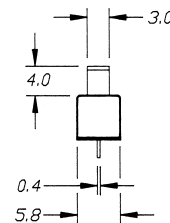
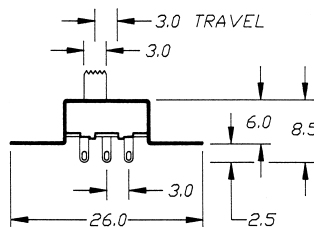

Schematic

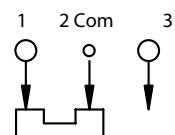

SLIDE SWITCHES

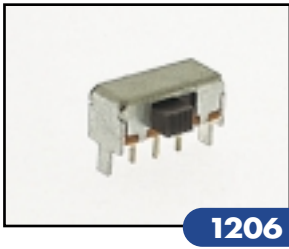

1206

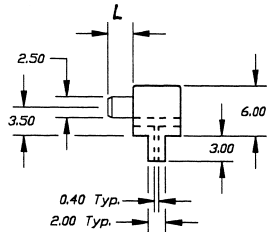
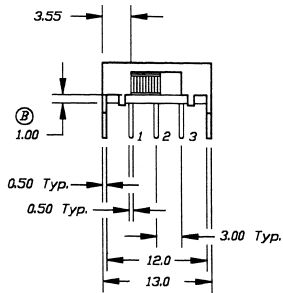
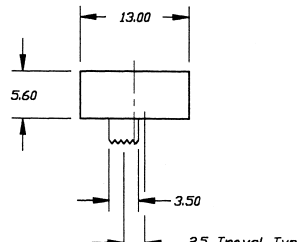

P.C. MOUNTING

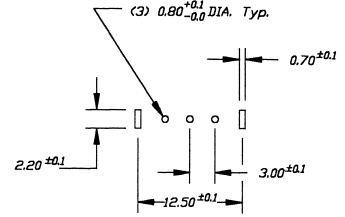

Schematic

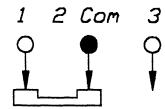

Model No.	L
EG1206	3
EG1206A	6

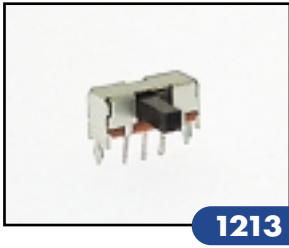

1213

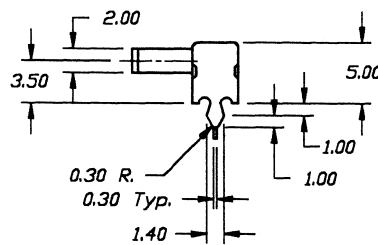
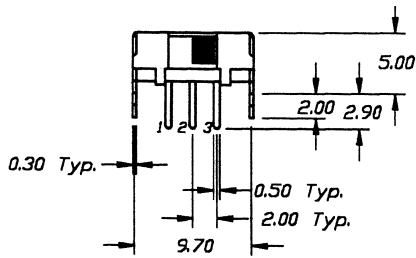
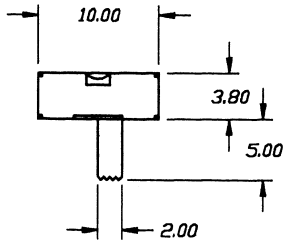

P.C. MOUNTING

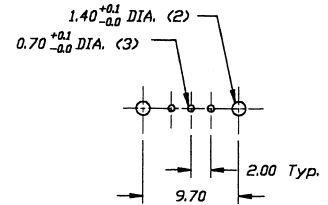

Schematic

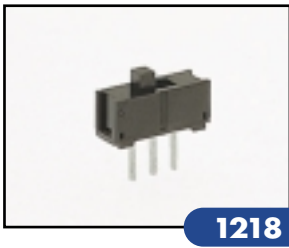
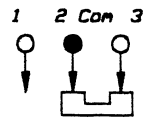

1218

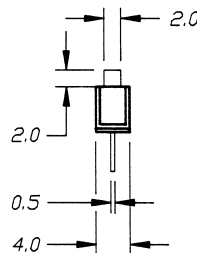
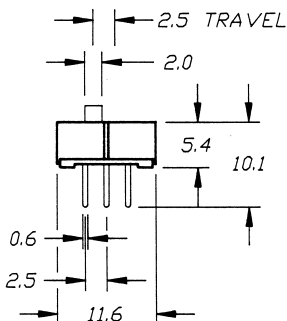

P.C. MOUNTING

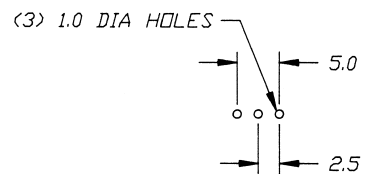

Schematic

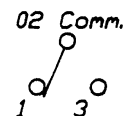

SPECIFICATIONS SUBJECT TO CHANGE WITHOUT NOTICE.

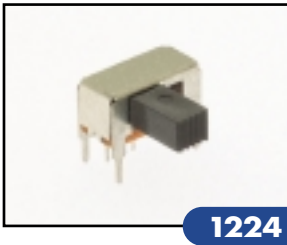

1224

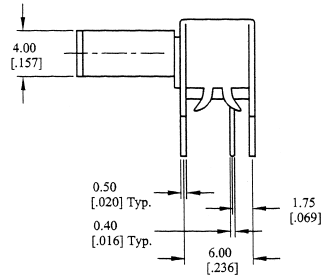
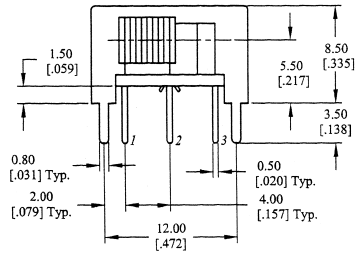
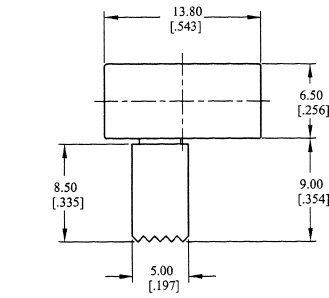

P.C. MOUNTING

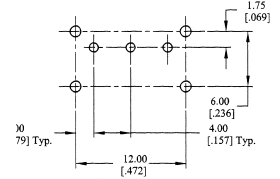

Schematic

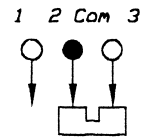

1247

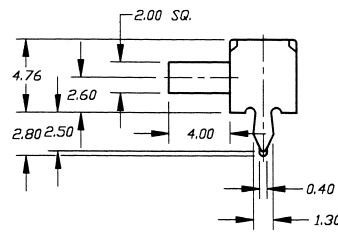
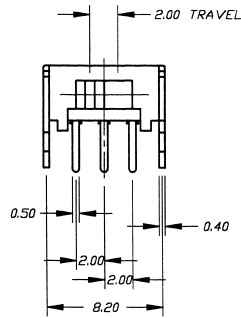
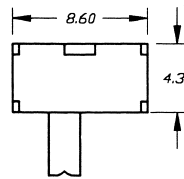

P.C. MOUNTING

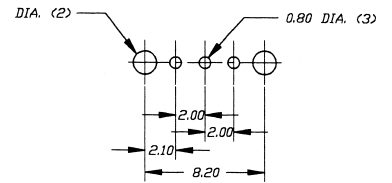

Schematic

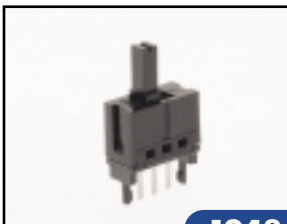
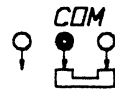

1248

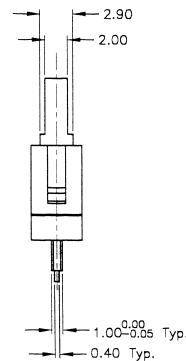
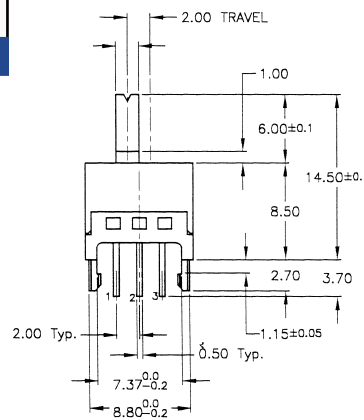
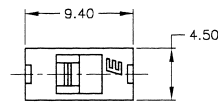

P.C. MOUNTING

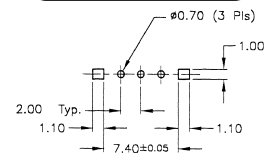

Schematic

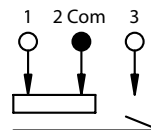

SPECIFICATIONS SUBJECT TO CHANGE WITHOUT NOTICE.

SLIDE SWITCHES

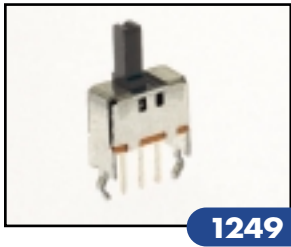

1249

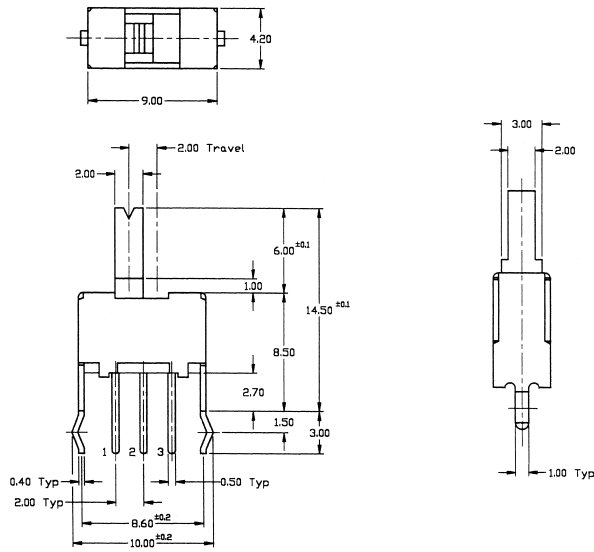

P.C. MOUNTING

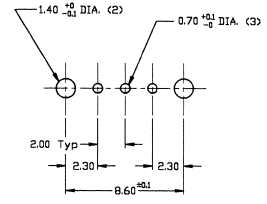

Schematic

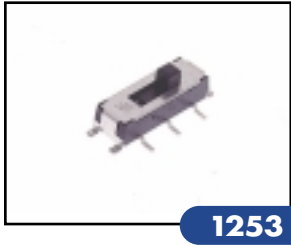
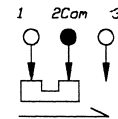

1253

Momentary Only

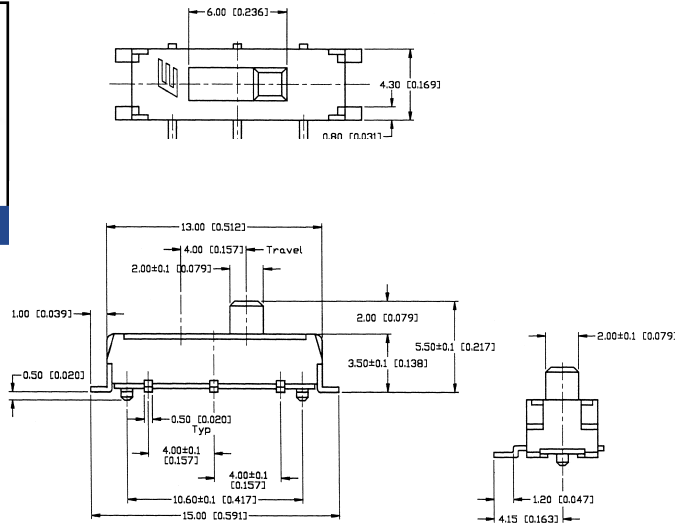

P.C. MOUNTING

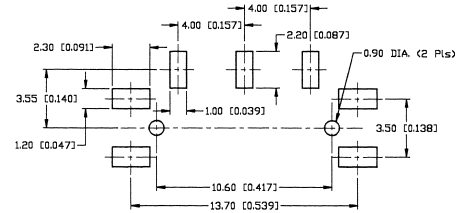

Schematic

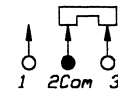

1257

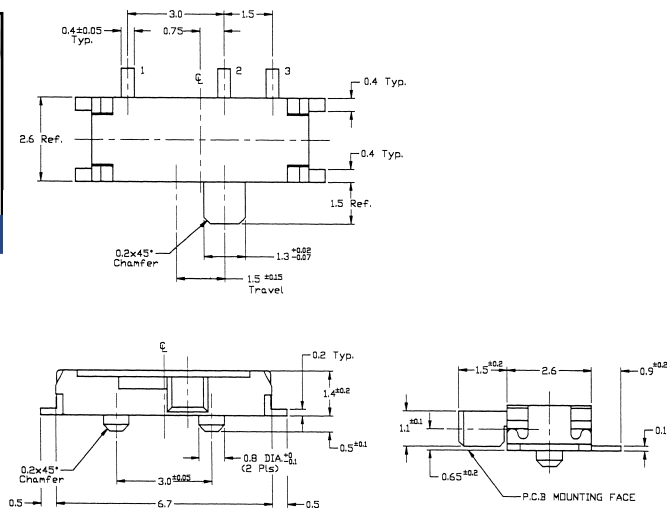

P.C. MOUNTING

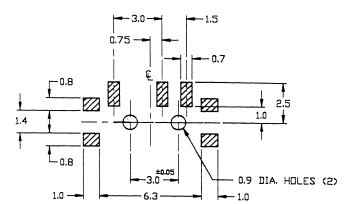

Schematic

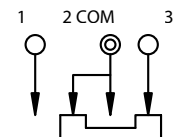

SPECIFICATIONS SUBJECT TO CHANGE WITHOUT NOTICE.



1270

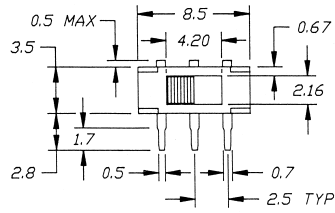

P.C. MOUNTING

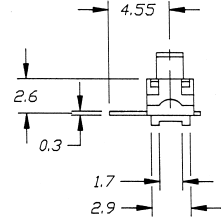
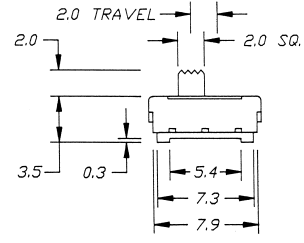
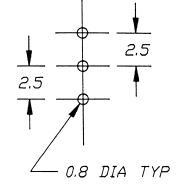

Schematic

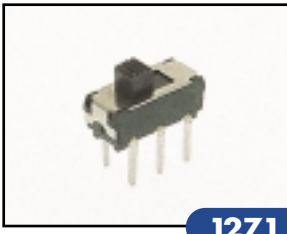
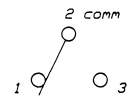

1271

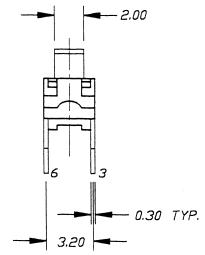
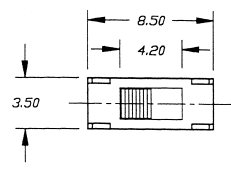

P.C. MOUNTING

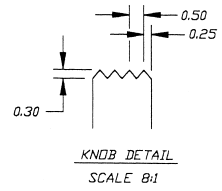
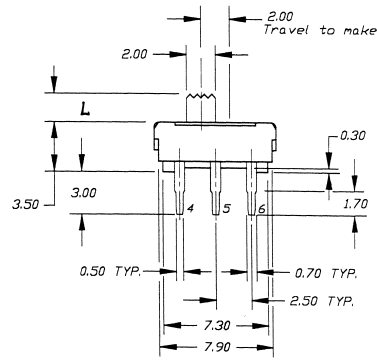
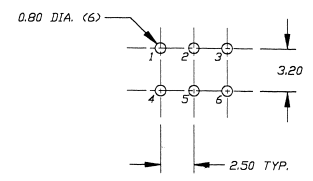

Schematic

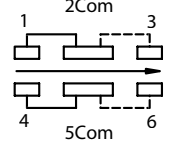

Model No.	L
EG1271	2
EG1271A	4.4

SPECIFICATIONS SUBJECT TO CHANGE WITHOUT NOTICE.

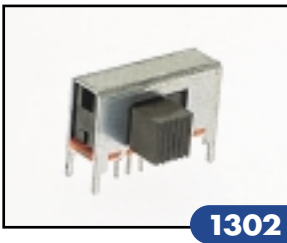

1302

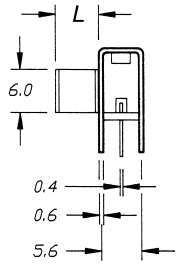
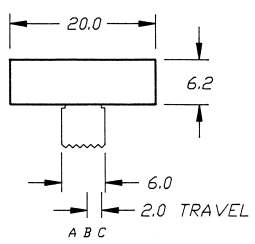

P.C. MOUNTING

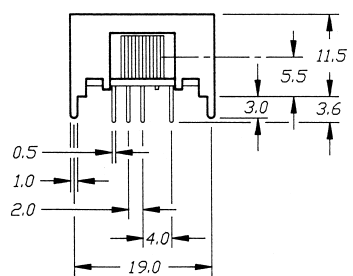
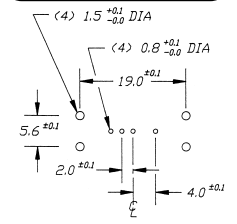

Schematic

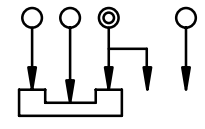

Model No.	L
EG1302	6
EG1302A	9

SLIDE SWITCHES

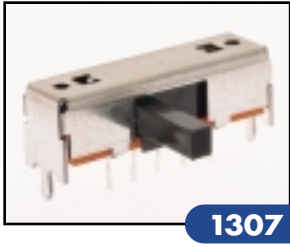

1307

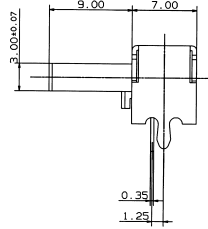
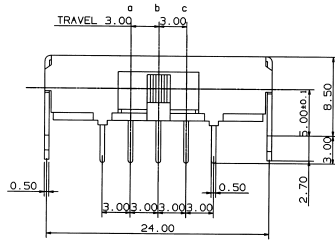
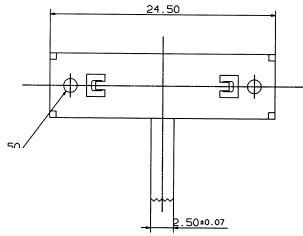

P.C. MOUNTING

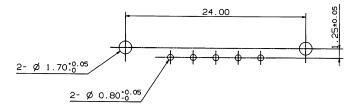

Schematic

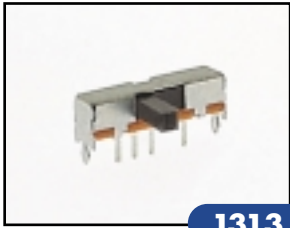
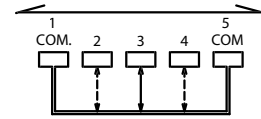

1313

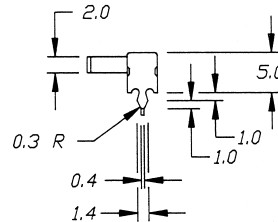
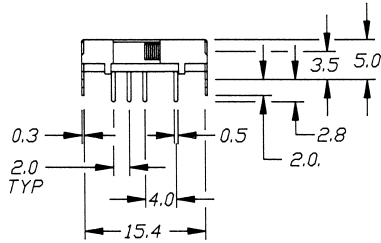
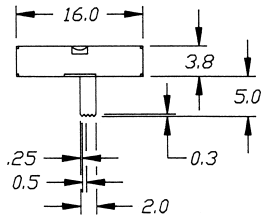

P.C. MOUNTING

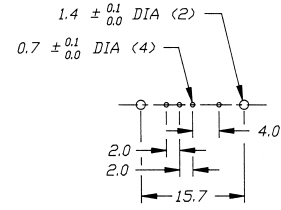

Schematic

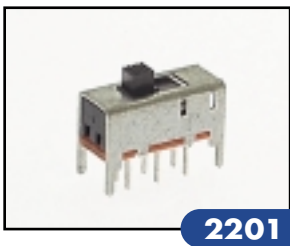
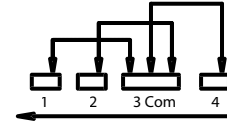

2201

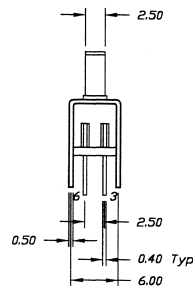
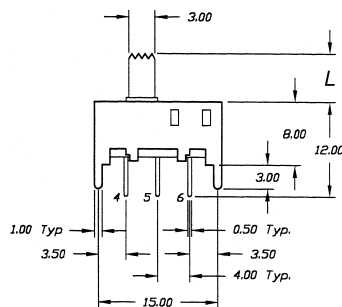
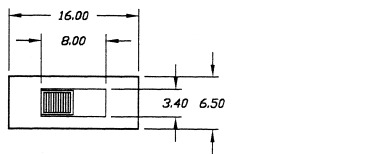

P.C. MOUNTING

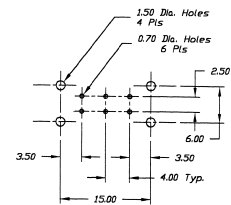

Schematic

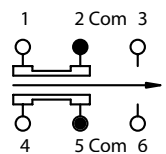

Model No.	L
EG2201	3
EG2201A	6
EG2201B	9
EG2201C	12
EG2201D	9.5

SPECIFICATIONS SUBJECT TO CHANGE WITHOUT NOTICE.

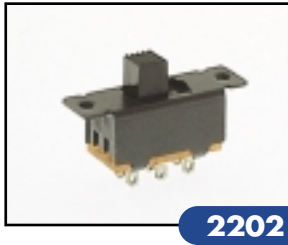

2202

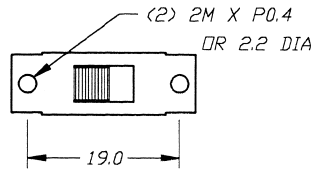

P.C. MOUNTING

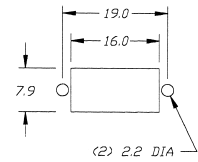

Model No.	L
EG2202	5
EG2202A	7.5
EG2202B	9

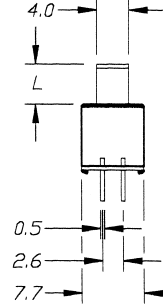
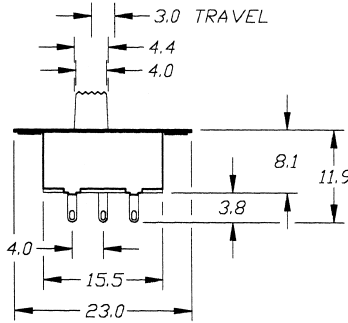

Schematic

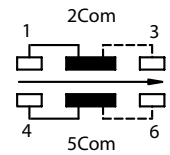

2205

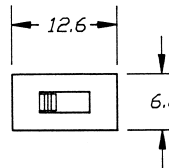

P.C. MOUNTING

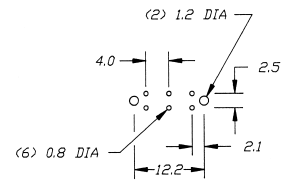

Model No.	L
EG2205	4
EG2205A	2

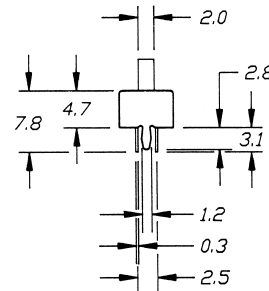
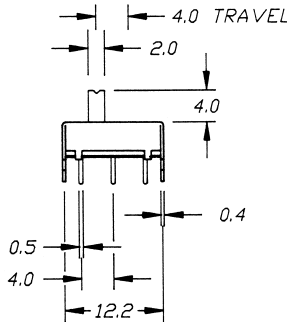

Schematic

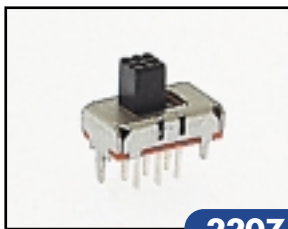
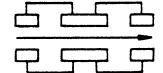

2207

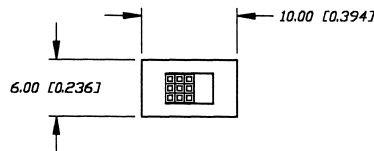

P.C. MOUNTING

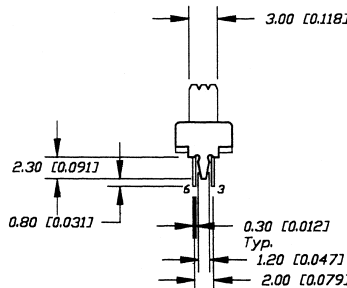
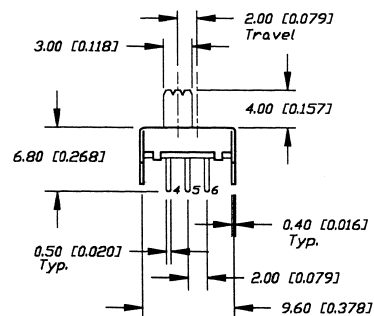
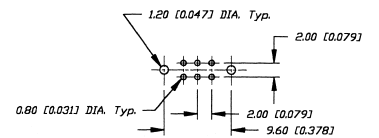

Schematic

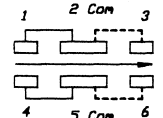

SPECIFICATIONS SUBJECT TO CHANGE WITHOUT NOTICE.

SLIDE SWITCHES

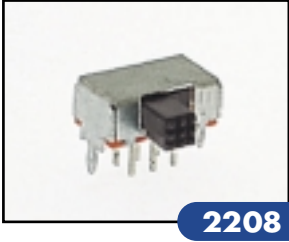

2208

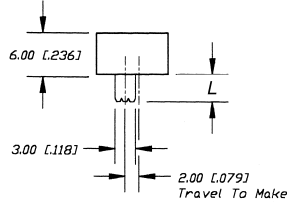

P.C. MOUNTING

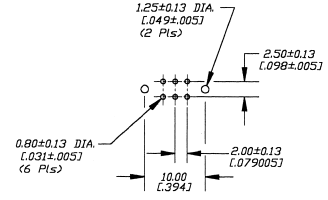

Model No.	L
EG2208	4
EG2208A	6

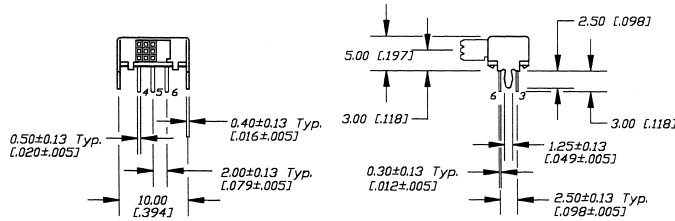

Schematic

Need #353



2209

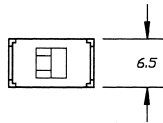

P.C. MOUNTING

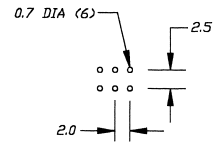

Model No.	L
EG2209	2
EG2209A	4

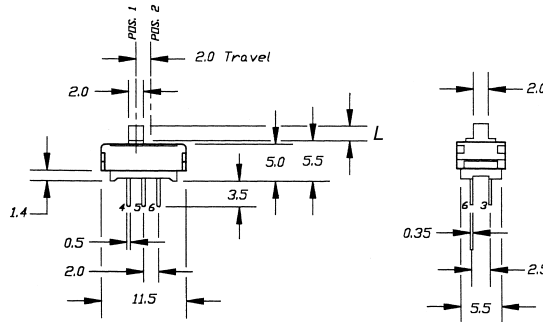

Schematic

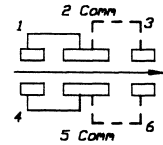

2210

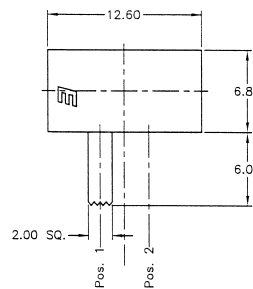

P.C. MOUNTING

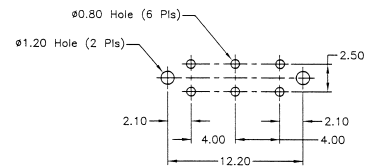

Model No.	L
EG2210	6
EG2210A	4
EG2210D	2

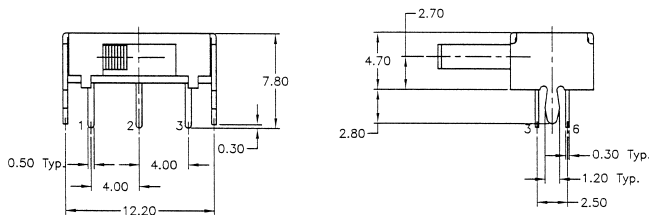

Schematic

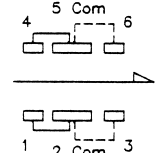

SPECIFICATIONS SUBJECT TO CHANGE WITHOUT NOTICE.

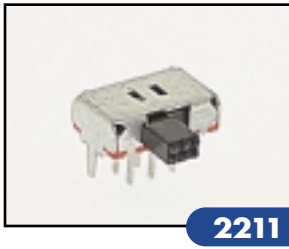

2211

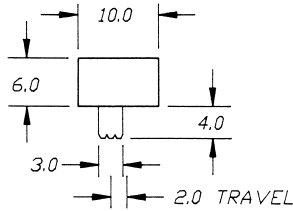

P.C. MOUNTING

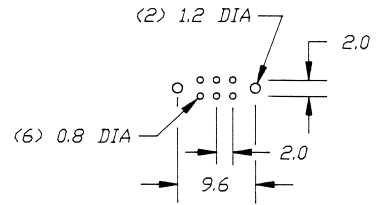

Model No.	L
EG2211	4
EG2211A	2

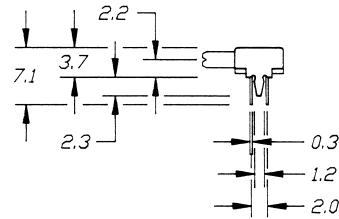
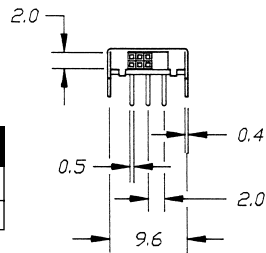

Schematic

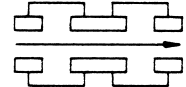

2214

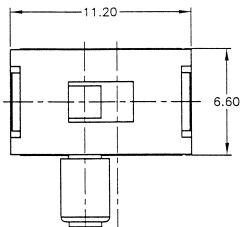

P.C. MOUNTING

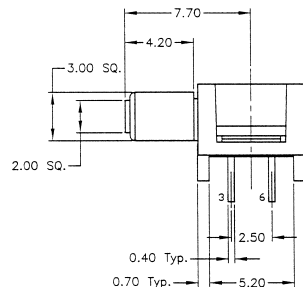
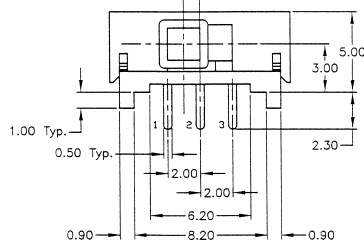
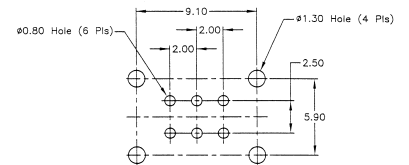

Schematic

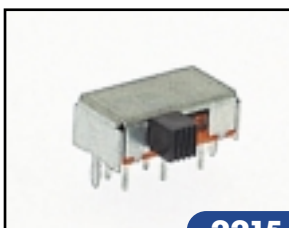
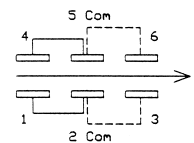

2215

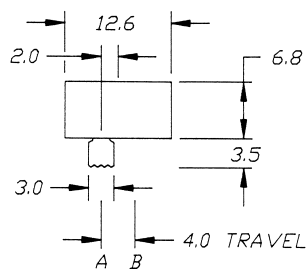

P.C. MOUNTING

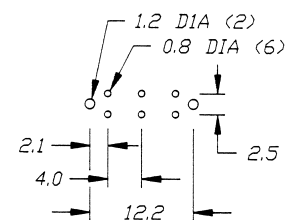

Model No.	L
EG2215	3.5
EG2215A	6

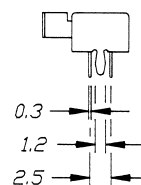
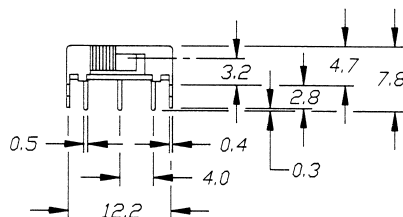

Schematic

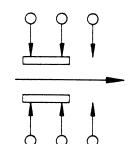

SPECIFICATIONS SUBJECT TO CHANGE WITHOUT NOTICE.

SLIDE SWITCHES

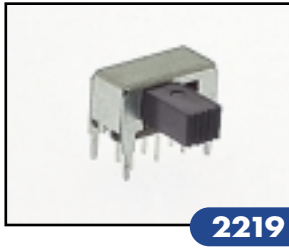

2219

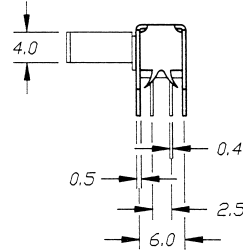
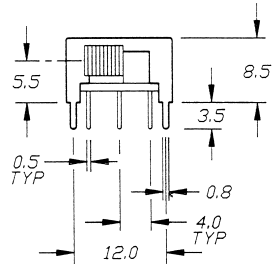
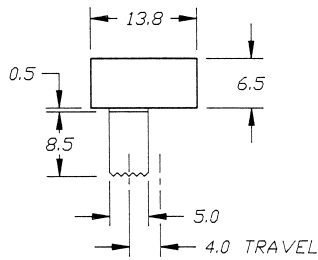

P.C. MOUNTING

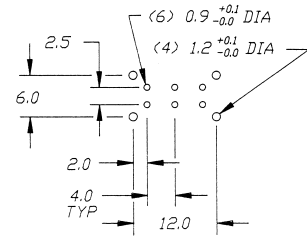

Schematic

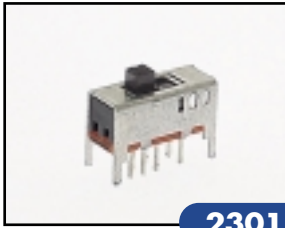
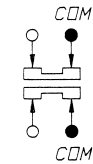

2301

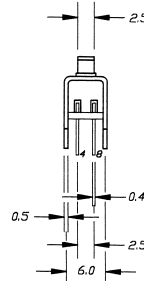
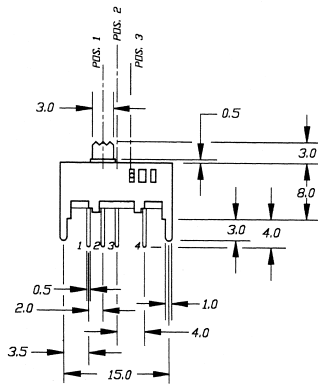
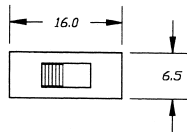

P.C. MOUNTING

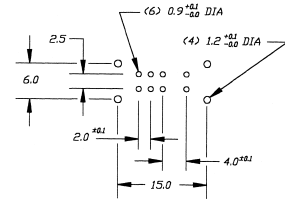

Schematic

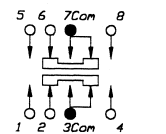

Model No.	L
EG2301	3
EG2301A	6
EG2301B	9
EG2301C	12



2303

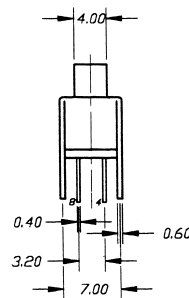
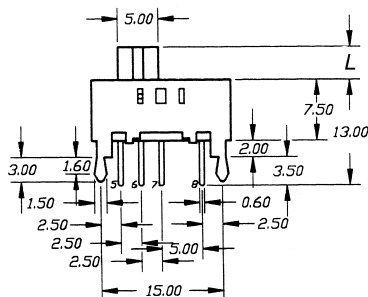
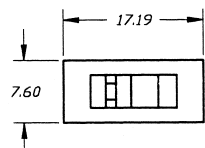

P.C. MOUNTING

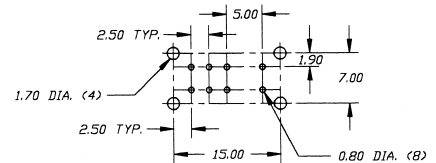

Schematic

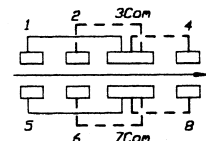

SPECIFICATIONS SUBJECT TO CHANGE WITHOUT NOTICE.

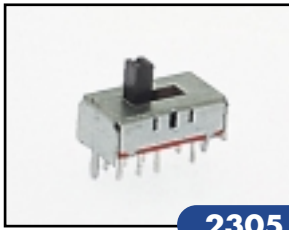

2305

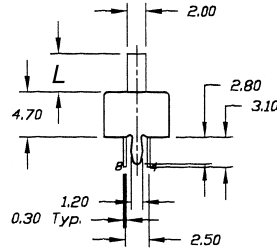
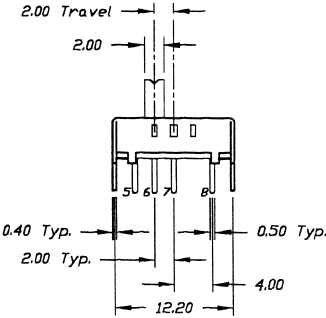
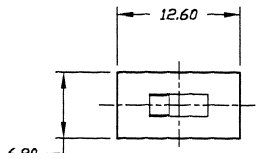

P.C. MOUNTING

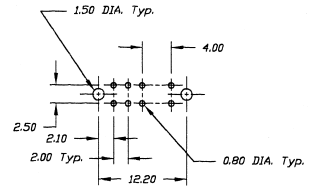

Schematic

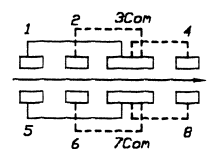

Model No.	L
EG2305	4
EG2305A	2



2308

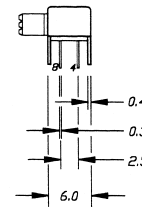
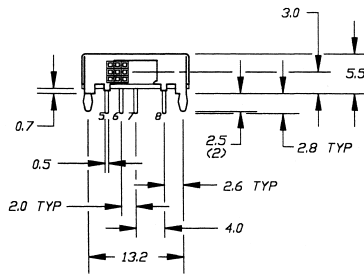
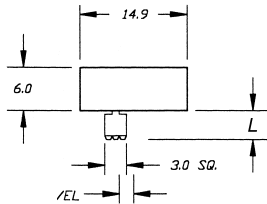

P.C. MOUNTING

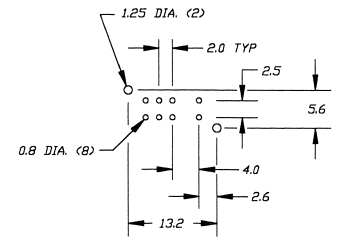

Schematic

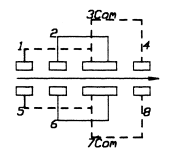

Model No.	L
EG2308	4
EG2308A	6



2310

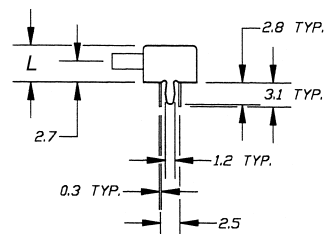
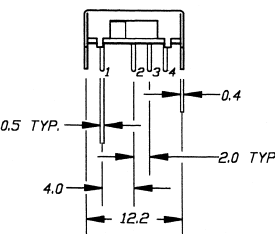
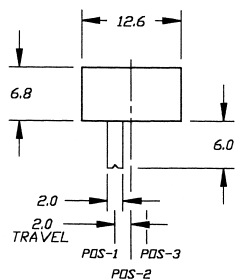

P.C. MOUNTING

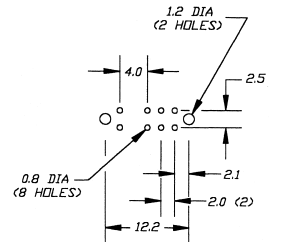

Schematic

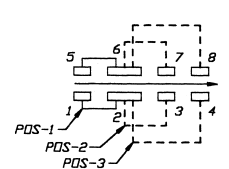

Model No.	L
EG2310	6
EG2310A	4

SPECIFICATIONS SUBJECT TO CHANGE WITHOUT NOTICE.

SLIDE SWITCHES

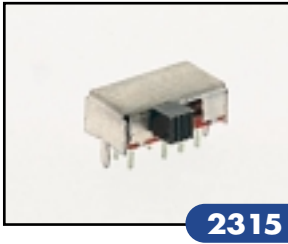

2315

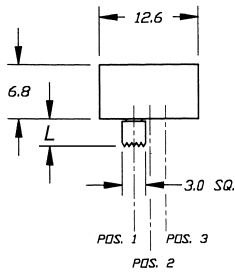

P.C. MOUNTING

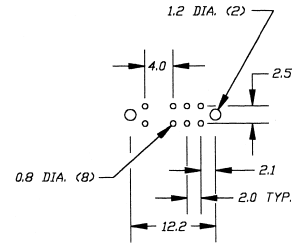

Model No.	L
EG2315	3.5
EG2315A	6

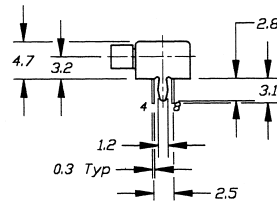
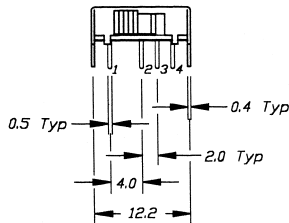

Schematic

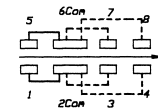

2319

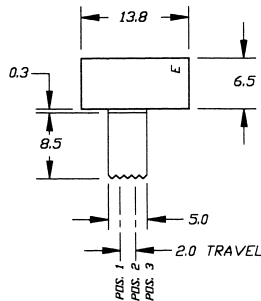

P.C. MOUNTING

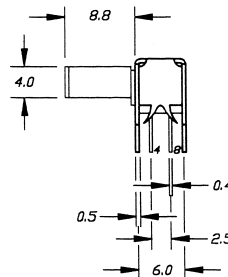
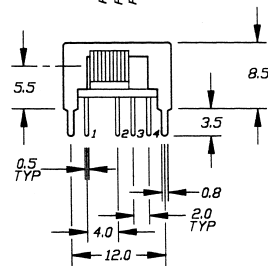
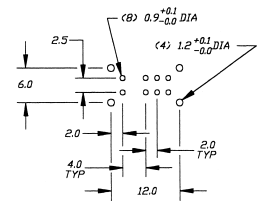

Schematic

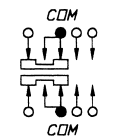

2322

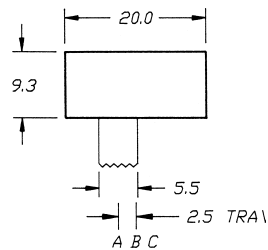

P.C. MOUNTING

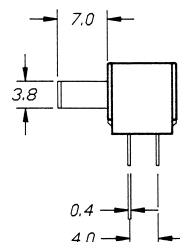
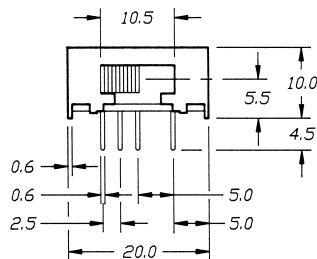
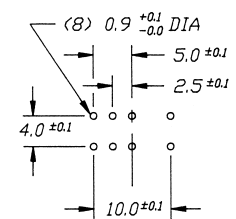

Schematic

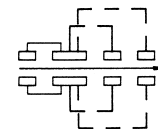

SPECIFICATIONS SUBJECT TO CHANGE WITHOUT NOTICE.

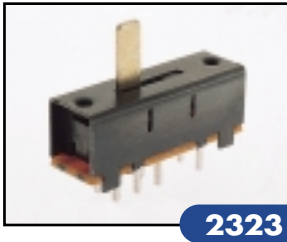

2323

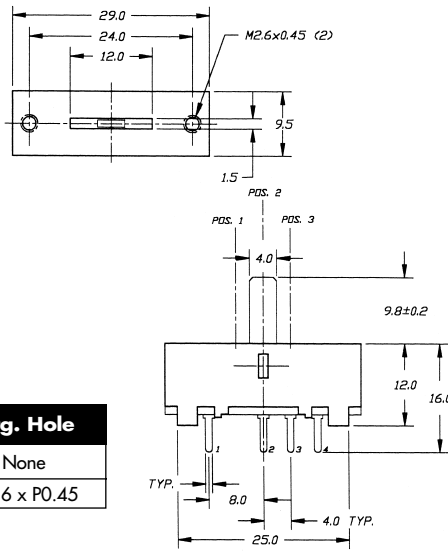

P.C. MOUNTING

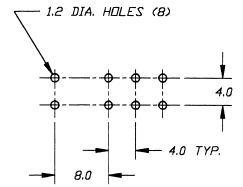

Model No.	Mtg. Hole
EG2323	None
EG2323A	M2.6 x P0.45

Schematic

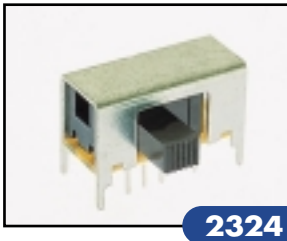
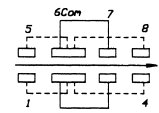

2324

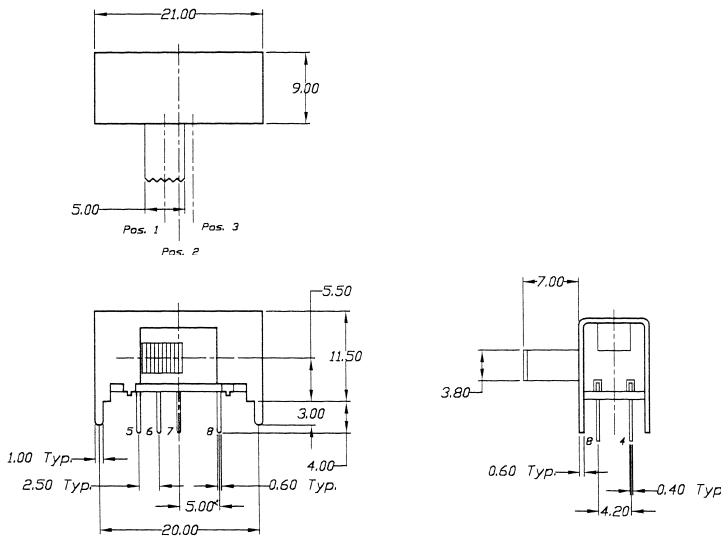

P.C. MOUNTING

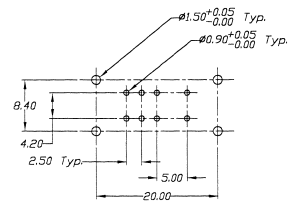

Schematic

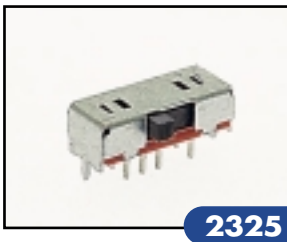
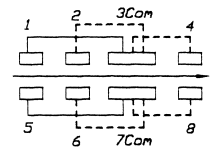

2325

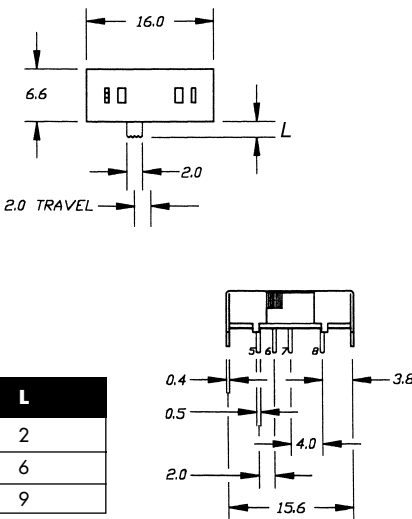

P.C. MOUNTING

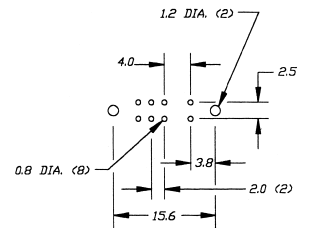

Model No.	L
EG2325	2
EG2325A	6
EG2325B	9

Schematic

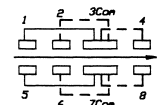

SPECIFICATIONS SUBJECT TO CHANGE WITHOUT NOTICE.

SLIDE SWITCHES

P.C. MOUNTING

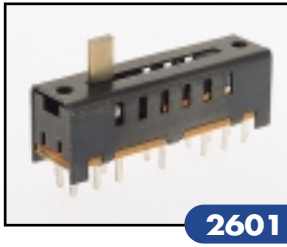

2601

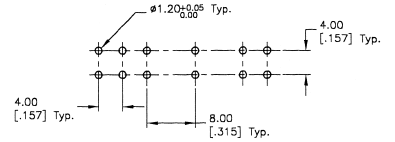
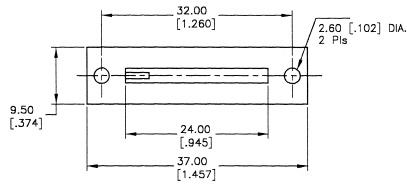

Model No.	L	"A"
EG2601	9.8	None
EG2601A	9.8	M2.6 x P0.45
EG2601B	6.5	M2.6 x P0.45
EG2601C	6.5	None

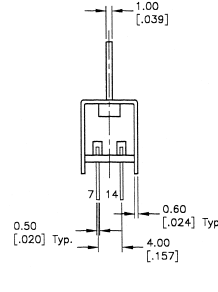
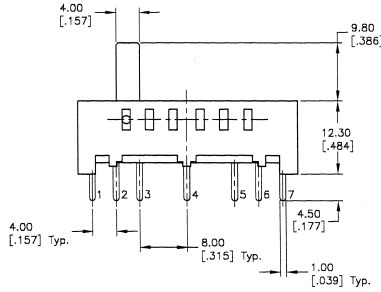

Schematic

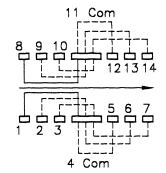

P.C. MOUNTING

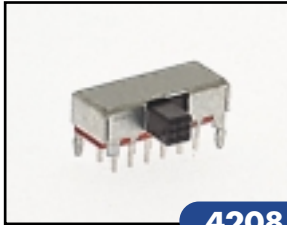

4208

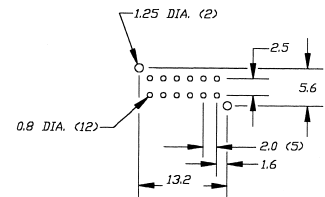
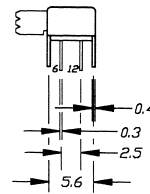
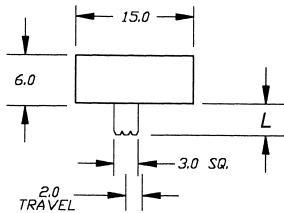

Model No.	L
EG4208	4
EG4208A	6

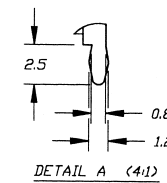
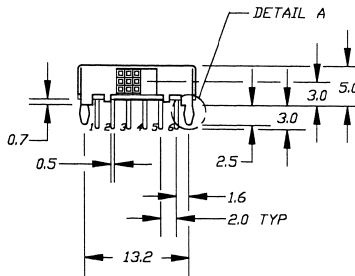

Schematic

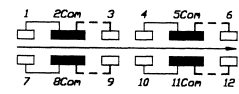

P.C. MOUNTING

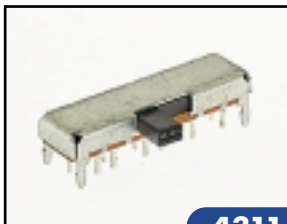

4311

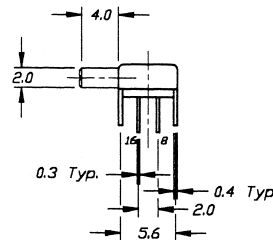
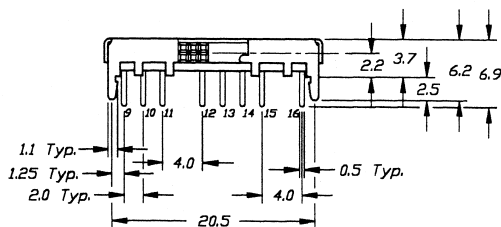
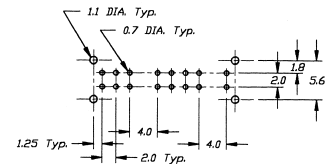
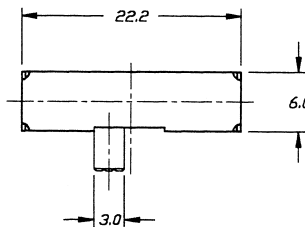

Schematic

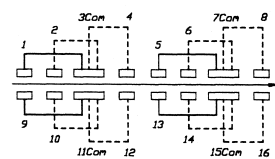

SPECIFICATIONS SUBJECT TO CHANGE WITHOUT NOTICE.

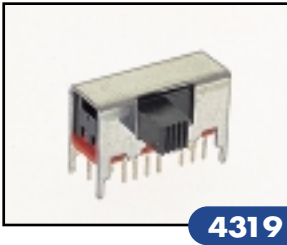

4319

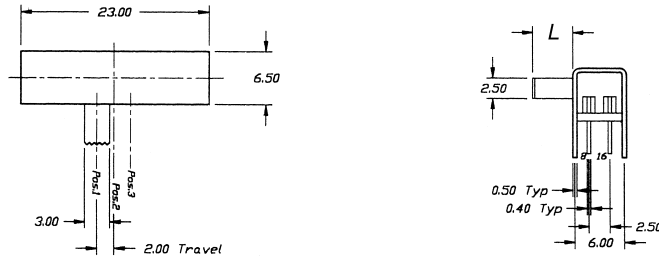

P.C. MOUNTING

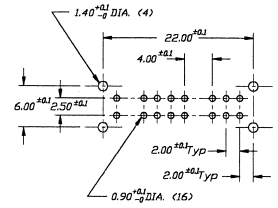

Model No.	L
EG4319	5
EG4319A	6

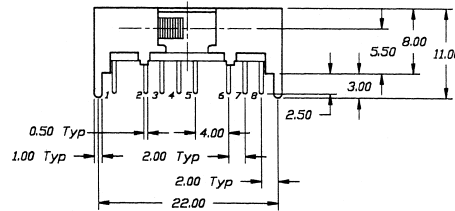

Schematic

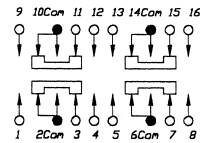

6201

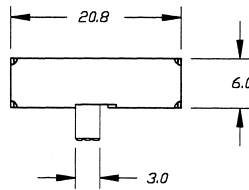

P.C. MOUNTING

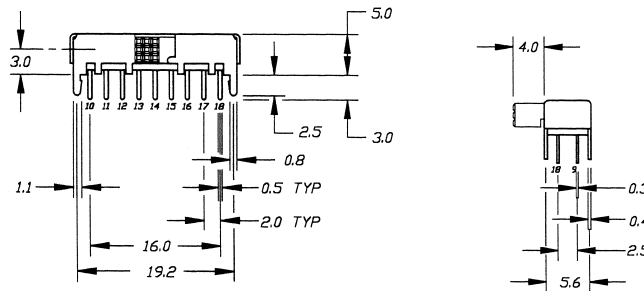
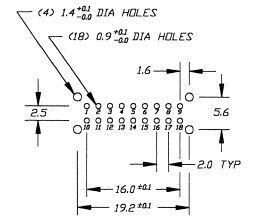

Schematic

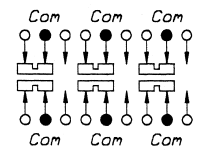

SPECIFICATIONS SUBJECT TO CHANGE WITHOUT NOTICE.