

# 1.8V to 3.3V, Micro-Power, $\pm 15\text{kV}$ ESD, $+125^\circ\text{C}$ , Slew Rate Limited, RS-485/RS-422 Transceivers

## ISL32600E, ISL32601E, ISL32602E, ISL32603E

The Intersil ISL32600E, ISL32601E, ISL32602E and ISL32603E are  $\pm 15\text{kV}$  IEC61000 ESD protected, micro power, wide supply range transceivers for differential communication. The ISL32600E and ISL32601E operate with  $V_{CC} \geq 2.7\text{V}$  and have maximum supply currents as low as  $100\mu\text{A}$  with both the transmitter (Tx) and receiver (Rx) enabled. The ISL32602E and ISL32603E operate with supply voltages as low as  $1.8\text{V}$ . These transceivers have very low bus currents, so they present less than a "1/8 unit load" to the bus. This allows more than 256 transmitters on the network, without violating the RS-485 specification's 32 unit load maximum.

Rx inputs feature symmetrical switching thresholds, and up to  $65\text{mV}$  of hysteresis, to improve noise immunity and to reduce duty cycle distortion in the presence of slow moving input signals (see Figure 9). The Rx input common mode range is the full  $-7\text{V}$  to  $+12\text{V}$  RS-485 range for supply voltages  $\geq 3\text{V}$ .

Hot Plug circuitry ensures that the Tx and Rx outputs remain in a high impedance state while the power supply stabilizes.

This transceiver family utilizes slew rate limited drivers, which reduce EMI, and minimize reflections from improperly terminated transmission lines, or unterminated stubs in multidrop and multipoint applications.

The ISL32600E and ISL32602E are configured for full duplex (separate Rx input and Tx output pins) applications. The half duplex versions multiplex the Rx inputs and Tx outputs to allow transceivers with output disable functions in 8 Ld packages. See Table 1 for a summary of each device's features.

## Features

- Single 1.8V, 3V, or 3.3V Supply
- Low Supply Currents . . . . . ISL32601E,  $100\mu\text{A}$  (Max) @ 3V  
. . . . . ISL32603E,  $150\mu\text{A}$  (Max) @ 1.8V
  - Ultra Low Shutdown Supply Current . . . . .  $10\text{nA}$
- IEC61000 ESD Protection on RS-485 I/O Pins . . . . .  $\pm 15\text{kV}$ 
  - Class 3 ESD Levels on all Other Pins . . . . .  $>8\text{kV}$  HBM
- Symmetrical Switching Thresholds for Less Duty Cycle Distortion (See Figure 9)
- Up to  $65\text{mV}$  Hysteresis for Improved Noise Immunity
- Data Rates from  $128\text{kbps}$  to  $460\text{kbps}$
- Specified for  $+125^\circ\text{C}$  Operation
- 1/8 Unit Load Allows up to 256 Devices on the Bus
- $-7\text{V}$  to  $+12\text{V}$  Common Mode Input/Output Voltage Range ( $V_{CC} \geq 3\text{V}$ )
- Half and Full Duplex Pinouts; Three State Rx and Tx Outputs
- 5V Tolerant Logic Inputs
- Tiny MSOP Packages Consume 50% Less Board Space

## Applications

- Differential Sensor Interfaces
- Process Control Networks
- Security Camera Networks
- Building Environmental Control/Lighting Systems

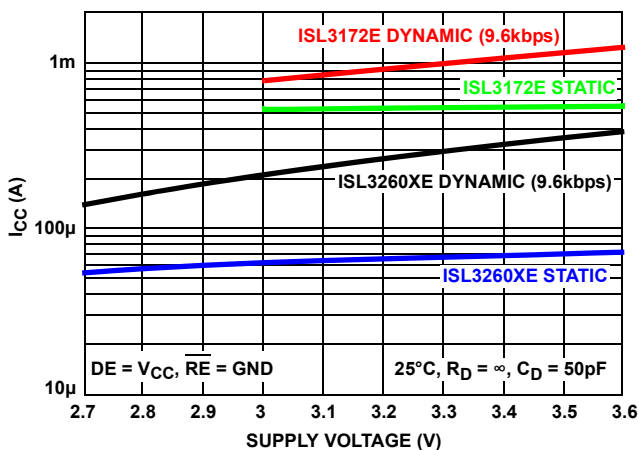

FIGURE 1. ISL32600E AND ISL32601E HAVE A 9.6kbps OPERATING  $I_{CC}$  LOWER THAN THE STATIC  $I_{CC}$  OF MANY EXISTING 3V TRANSCEIVERS

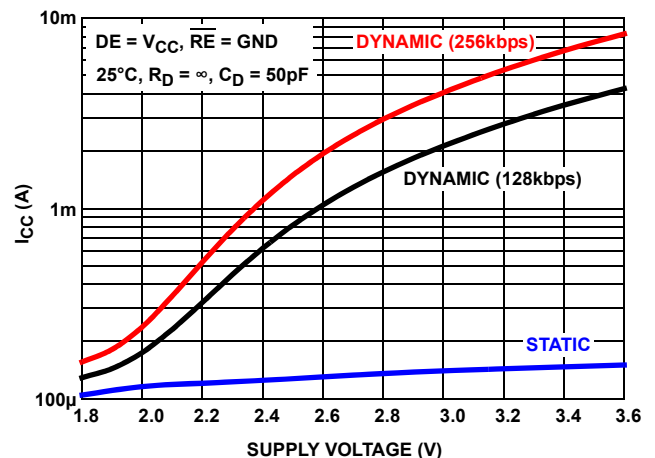

FIGURE 2. ISL32602E AND ISL32603E WITH  $V_{CC} = 1.8\text{V}$  REDUCE OPERATING  $I_{CC}$  BY A FACTOR OF 25 TO 40, COMPARED WITH  $I_{CC}$  AT  $V_{CC} = 3.3\text{V}$

# ISL32600E, ISL32601E, ISL32602E, ISL32603E

TABLE 1. SUMMARY OF FEATURES

PART NUMBER	SUPPLY RANGE (V)	HALF/FULL DUPLEX	DATA RATE (kbps)	SLEW-RATE LIMITED?	HOT PLUG?	# DEVICES ON BUS	RX/TX ENABLE?	QUIESCENT I <sub>CC</sub> (μA)	LOW POWER SHUTDOWN?	PIN COUNT
ISL32600E	2.7 to 3.6	FULL	128 - 256	YES	YES	256	YES	60 @ 3V	YES	10, 14
ISL32601E	2.7 to 3.6	HALF	128 - 256	YES	YES	256	YES	60 @ 3V	YES	8
ISL32602E	1.8 to 3.6	FULL	256 - 460	YES	YES	256	YES	105 @ 1.8V	YES	10, 14
ISL32603E	1.8 to 3.6	HALF	256 - 460	YES	YES	256	YES	105 @ 1.8V	YES	8

## Pin Configurations

ISL32601E, ISL32603E  
(8 LD MSOP, SOIC)  
TOP VIEW

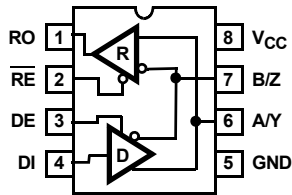

ISL32600E, ISL32602E  
(10 LD MSOP)  
TOP VIEW

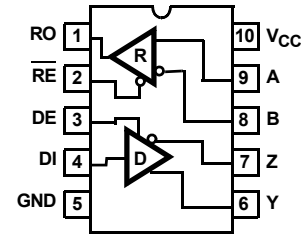

ISL32600E, ISL32602E  
(14 LD SOIC)  
TOP VIEW

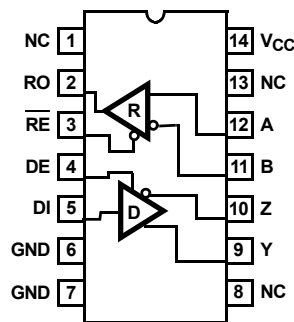

## Ordering Information

PART NUMBER (Notes 1, 2, 3)	PART MARKING	TEMP. RANGE (°C)	PACKAGE (Pb-Free)	PKG. DWG. #
ISL32600EFBZ	32600EFBZ	-40 to +125	14 Ld SOIC	M14.15
ISL32600EFUZ	32600	-40 to +125	10 Ld MSOP	M10.118
ISL32601EFBZ	32601 EFBZ	-40 to +125	8 Ld SOIC	M8.15
ISL32601EFUZ	32601	-40 to +125	8 Ld MSOP	M8.118
ISL32602EFBZ	32602EFBZ	-40 to +125	14 Ld SOIC	M14.15
ISL32602EFUZ	32602	-40 to +125	10 Ld MSOP	M10.118
ISL32603EFBZ	32603 EFBZ	-40 to +125	8 Ld SOIC	M8.15
ISL32603EFUZ	32603	-40 to +125	8 Ld MSOP	M8.118

NOTES:

1. Add "-T" (full reel) or "-T7A" (250 piece reel) suffix for tape and reel. Please refer to TB347 for details on reel specifications.
2. These Intersil Pb-free plastic packaged products employ special Pb-free material sets, molding compounds/die attach materials, and 100% matte tin plate plus anneal (e3 termination finish, which is RoHS compliant and compatible with both SnPb and Pb-free soldering operations). Intersil Pb-free products are MSL classified at Pb-free peak reflow temperatures that meet or exceed the Pb-free requirements of IPC/JEDEC J STD-020.
3. For Moisture Sensitivity Level (MSL), please see device information page for [ISL32600E](#), [ISL32601E](#), [ISL32602E](#), [ISL32603E](#). For more information on MSL please see tech brief [TB363](#).

# ISL32600E, ISL32601E, ISL32602E, ISL32603E

## Truth Tables

TRANSMITTING				
INPUTS			OUTPUTS	
$\overline{RE}$	DE	DI	Z	Y
X	1	1	0	1
X	1	0	1	0
0	0	X	High-Z	High-Z
1	0	X	High-Z *	High-Z *

NOTE: \*Shutdown Mode (See Note 11).

## Truth Tables (continued)

RECEIVING				
INPUTS				OUTPUT
$\overline{RE}$	DE Half Duplex	DE Full Duplex	A-B	RO
0	0	X	$\geq 0.2V$	1
0	0	X	$\leq -0.2V$	0
0	0	X	Inputs Open	1
1	0	0	X	High-Z *
1	1	1	X	High-Z

NOTE: \*Shutdown Mode (See Note 11).

## Pin Descriptions

PIN	8 LD PACKAGE	10 LD PACKAGE	14 LD PACKAGE	FUNCTION
RO	1	1	2	Receiver output: If $A-B \geq 200mV$ , RO is high; If $A-B \leq -200mV$ , RO is low; RO = High if A and B are unconnected (floating).
$\overline{RE}$	2	2	3	Receiver output enable. RO is enabled when $\overline{RE}$ is low; RO is high impedance when $\overline{RE}$ is high. If the Rx enable function isn't required, connect $\overline{RE}$ directly to GND.
DE	3	3	4	Driver output enable. The driver outputs, Y and Z, are enabled by bringing DE high, and are high impedance when DE is low. If the Tx enable function isn't required, connect DE to $V_{CC}$ .
DI	4	4	5	Driver input. A low on DI forces output Y low and output Z high. Similarly, a high on DI forces output Y high and output Z low.
GND	5	5	6, 7	Ground connection.
A/Y	6	-	-	$\pm 15kV$ IEC61000 ESD Protected RS-485/422 level, noninverting receiver input and noninverting driver output. Pin is an input if DE = 0; pin is an output if DE = 1.
B/Z	7	-	-	$\pm 15kV$ IEC61000 ESD Protected RS-485/422 level, Inverting receiver input and inverting driver output. Pin is an input if DE = 0; pin is an output if DE = 1.
A	-	9	12	$\pm 15kV$ IEC61000 ESD Protected RS-485/422 level, noninverting receiver input.
B	-	8	11	$\pm 15kV$ IEC61000 ESD Protected RS-485/422 level, inverting receiver input.
Y	-	6	9	$\pm 15kV$ IEC61000 ESD Protected RS-485/422 level, noninverting driver output.
Z	-	7	10	$\pm 15kV$ IEC61000 ESD Protected RS-485/422 level, inverting driver output.
$V_{CC}$	8	10	14	System power supply input (2.7V to 3.6V for ISL32600E and ISL32601E; 1.8V to 3.6V for ISL32602E and ISL32603E).
NC	-	-	1, 8, 13	No Internal Connection.

Typical Operating Circuits

HALF DUPLEX NETWORK USING ISL32603E

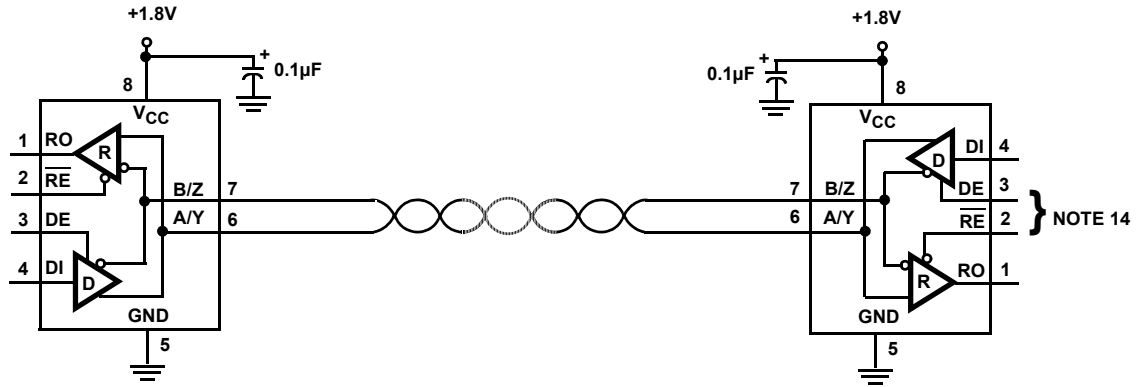

FULL DUPLEX NETWORK USING ISL32600E  
(PIN NUMBERS FOR SOIC)

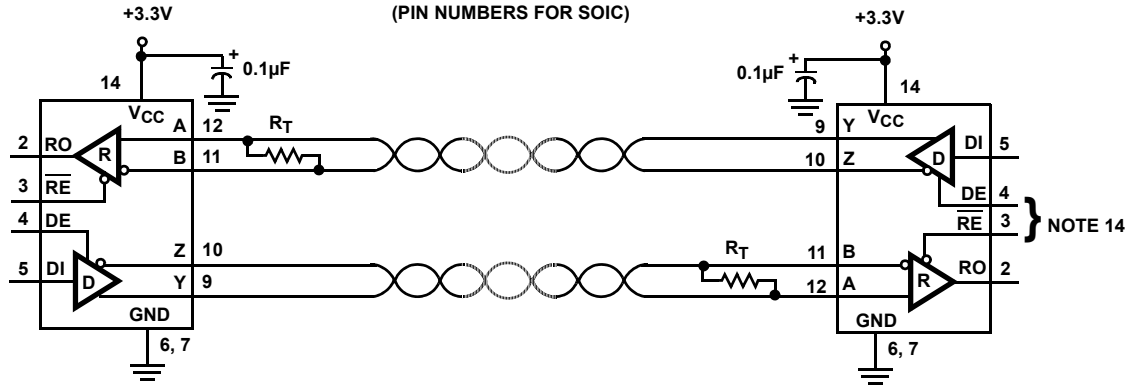

# ISL32600E, ISL32601E, ISL32602E, ISL32603E

## Absolute Maximum Ratings

V <sub>CC</sub> to GND	7V
Input Voltages	
DI, DE, $\overline{RE}$	-0.3V to 7V
Input/Output Voltages	
A, B	-8V to +13V
A/Y, B/Z, Y, Z (V <sub>CC</sub> = 0V or ≥ 3V)	-8V to +13V
A/Y, B/Z, Y, Z (1.8V ≤ V <sub>CC</sub> < 3V)	-8V to +11V
RO	-0.3V to (V <sub>CC</sub> + 0.3V)
Short Circuit Duration	
Y, Z	Indeterminate
ESD Rating	See Specification Table
Latch-up (per JESD78, Level 2, Class A)	+125 °C

## Recommended Operating Conditions

Supply Voltage Range	
ISL32600E, ISL32601E	3V to 3.3V
ISL32602E, ISL32603E	1.8V to 3.3V
Differential Load Resistance	
ISL32600E, ISL32601E	60Ω or 120Ω
ISL32602E, ISL32603E	≥10kΩ @ 1.8V; 120Ω @ 3.3V

## Thermal Information

Thermal Resistance (Typical, Notes 4, 5)	θ <sub>JA</sub> (°C/W)	θ <sub>JC</sub> (°C/W)
8 Ld SOIC Package	105	47
8 Ld MSOP Package	140	40
10 Ld MSOP Package	160	59
14 Ld SOIC Package	128	39
Maximum Junction Temperature (Plastic Package)	+150 °C	
Maximum Storage Temperature Range	-65 °C to +150 °C	
Pb-free reflow profile	see link below	
	<a href="http://www.intersil.com/pbfree/Pb-FreeReflow.asp">http://www.intersil.com/pbfree/Pb-FreeReflow.asp</a>	

## Recommended Operating Conditions (continued)

Common Mode Range	
ISL32600E, ISL32601E	-7V to +12V
ISL32602E, ISL32603E	
V <sub>CC</sub> = 1.8V	-2V to +2V
V <sub>CC</sub> = 3.3V	-7V to +12V
Temperature Range	-40 °C to +125 °C

CAUTION: Do not operate at or near the maximum ratings listed for extended periods of time. Exposure to such conditions may adversely impact product reliability and result in failures not covered by warranty.

### NOTES:

- θ<sub>JA</sub> is measured with the component mounted on a high effective thermal conductivity test board in free air. See Tech Brief [TB379](#) for details.
- For θ<sub>JC</sub>, the "case temp" location is taken at the package top center.

**Electrical Specifications ISL32600E, ISL32601E:** Test Conditions: V<sub>CC</sub> = 2.7V to 3.6V; Typicals are at V<sub>CC</sub> = 3V, T<sub>A</sub> = +25 °C; Unless Otherwise Specified. **Boldface limits apply over the operating temperature range.** (Note 6)

PARAMETER	SYMBOL	TEST CONDITIONS	TEMP (°C)	MIN (Note 15)	TYP	MAX (Note 15)	UNITS	
<b>DC CHARACTERISTICS</b>								
Driver Differential V <sub>OUT</sub>	V <sub>OD</sub>	R <sub>L</sub> = 100Ω (RS-422) (Figure 3A, V <sub>CC</sub> ≥ 3.15V)	Full	<b>1.95</b>	2.1	-	V	
		R <sub>L</sub> = 54Ω (RS-485) (Figure 3A)	V <sub>CC</sub> = 2.7V	Full	<b>1.2</b>	1.5	V <sub>CC</sub>	V
			V <sub>CC</sub> ≥ 3V	Full	<b>1.4</b>	1.7	V <sub>CC</sub>	V
		No Load	Full	-	-	V <sub>CC</sub>	V	
		R <sub>L</sub> = 60Ω, -7V ≤ V <sub>CM</sub> ≤ 12V (Figure 3B, V <sub>CC</sub> ≥ 3V)	Full	<b>1.3</b>	-	-	V	
Change in Magnitude of Driver Differential V <sub>OUT</sub> for Complementary Output States	ΔV <sub>OD</sub>	R <sub>L</sub> = 54Ω or 100Ω (Figure 3A)	Full	-	0.01	<b>0.2</b>	V	
Driver Common-Mode V <sub>OUT</sub>	V <sub>OC</sub>	R <sub>L</sub> = 54Ω or 100Ω (Figure 3A)	Full	-	-	<b>3</b>	V	
Change in Magnitude of Driver Common-Mode V <sub>OUT</sub> for Complementary Output States	ΔV <sub>OC</sub>	R <sub>L</sub> = 54Ω or 100Ω (Figure 3A)	Full	-	0.01	<b>0.2</b>	V	
Output Leakage Current (Y, Z) (Full Duplex Versions Only)	I <sub>OZD</sub>	DE = 0V, V <sub>CC</sub> = 0V (-7V ≤ V <sub>IN</sub> ≤ 12V) or 2.7V ≤ V <sub>CC</sub> ≤ 3.6V	V <sub>IN</sub> = 12V (V <sub>CC</sub> ≥ 3V)	Full	-	3	<b>60</b>	μA
			V <sub>IN</sub> = 10V (V <sub>CC</sub> = 2.7V)	Full	-	3	<b>60</b>	μA
			V <sub>IN</sub> = -7V	Full	<b>-30</b>	-10	-	μA
Driver Short-Circuit Current, V <sub>O</sub> = High or Low	I <sub>OSD</sub>	DE = V <sub>CC</sub> , -7V ≤ V <sub>Y</sub> or V <sub>Z</sub> ≤ 12V (Note 8)	Full	-	-	<b>±250</b>	mA	
Logic Input High Voltage	V <sub>IH</sub>	DI, DE, $\overline{RE}$	Full	<b>2</b>	-	-	V	
Logic Input Low Voltage	V <sub>IL</sub>	DI, DE, $\overline{RE}$	Full	-	-	<b>0.7</b>	V	
Logic Input Current	I <sub>IN1</sub>	DI = DE = $\overline{RE}$ = 0V or V <sub>CC</sub> (Note 14)	Full	<b>-1</b>	-	<b>1</b>	μA	

# ISL32600E, ISL32601E, ISL32602E, ISL32603E

**Electrical Specifications ISL32600E, ISL32601E:** Test Conditions:  $V_{CC} = 2.7V$  to  $3.6V$ ; Typicals are at  $V_{CC} = 3V$ ,  $T_A = +25^\circ C$ ; Unless Otherwise Specified. **Boldface limits apply over the operating temperature range.** (Note 6) (Continued)

PARAMETER	SYMBOL	TEST CONDITIONS	TEMP (°C)	MIN (Note 15)	TYP	MAX (Note 15)	UNITS	
Input Current (A, B, A/Y, B/Z)	$I_{IN2}$	$DE = 0V, V_{CC} = 0V$ ( $-7V \leq V_{IN} \leq 12V$ ) or $2.7V \leq V_{CC} \leq 3.6V$	$V_{IN} = 12V$ ( $V_{CC} \geq 2.7V$ for A, B)	Full	-	80	<b>125</b>	$\mu A$
			$V_{IN} = 12V$ ( $V_{CC} \geq 3V$ for A/Y, B/Z)	Full	-	80	<b>125</b>	$\mu A$
		$V_{IN} = 10V$ ( $V_{CC} = 2.7V$ for A/Y, B/Z)	Full	-	80	<b>125</b>	$\mu A$	
		$V_{IN} = -7V$	Full	<b>-100</b>	-50	-	$\mu A$	
Receiver Differential Threshold Voltage	$V_{TH}$	$-7V \leq V_{CM} \leq 12V$	Full	<b>-200</b>	0	<b>200</b>	mV	
Receiver Input Hysteresis	$\Delta V_{TH}$	$-7V \leq V_{CM} \leq 12V$	Full	-	40	-	mV	
Receiver Output High Voltage	$V_{OH}$	$I_O = -4mA, V_{ID} = 200mV$	Full	<b><math>V_{CC} - 0.5</math></b>	-	-	V	
Receiver Output Low Voltage	$V_{OL}$	$I_O = 4mA, V_{ID} = -200mV$	Full	-	-	<b>0.4</b>	V	
Three-State (high impedance) Receiver Output Current	$I_{OZR}$	$0V \leq V_O \leq V_{CC}, \overline{RE} = V_{CC}$	Full	<b>-1</b>	-	<b>1</b>	$\mu A$	
Receiver Short-Circuit Current	$I_{OSR}$	$0V \leq V_O \leq V_{CC}$	Full	-	30	<b><math>\pm 60</math></b>	mA	
<b>SUPPLY CURRENT</b>								
No-Load Supply Current (Note 7)	$I_{CC}$	$DI = 0V$ or $V_{CC}$ , $DE = V_{CC}, \overline{RE} = 0V$ or $V_{CC}$	$V_{CC} = 3V$	Full	-	60	<b>100</b>	$\mu A$
			$V_{CC} = 3.6V$	Full	-	70	<b>120</b>	$\mu A$
		$DI = 0V$ or $V_{CC}$ , Rx Only ( $DE = 0V, \overline{RE} = 0V$ )	$V_{CC} = 3V$	Full	-	42	<b>65</b>	$\mu A$
			$V_{CC} = 3.6V$	Full	-	46	<b>80</b>	$\mu A$
Shutdown Supply Current	$I_{SHDN}$	$DE = 0V, \overline{RE} = V_{CC}, DI = 0V$ or $V_{CC}$	Full	-	0.01	<b>1</b>	$\mu A$	
<b>ESD PERFORMANCE</b>								
RS-485 Pins (A, Y, B, Z, A/Y, B/Z)		IEC61000-4-2, Air-Gap Discharge Method	25	-	$\pm 15$	-	kV	
		IEC61000-4-2, Contact Discharge Method	25	-	$\pm 8$	-	kV	
		Human Body Model, From Bus Pins to GND	25	-	$\pm 15$	-	kV	
All Pins		HBM, per MIL-STD-883 Method 3015	25	-	$\pm 8$	-	kV	
		Machine Model	25	-	400	-	V	
<b>SWITCHING CHARACTERISTICS</b>								
Maximum Data Rate	$f_{MAX}$	$R_{DIFF} = 54\Omega$ , (Figures 6, 7)	$V_{CC} = 2.7V$	Full	<b>128</b>	-	-	kbps
			$V_{CC} \geq 3V$	Full	<b>256</b>	-	-	kbps
Driver Differential Output Delay	$t_{DD}$	$R_{DIFF} = 54\Omega, C_D = 50pF$ (Figure 4)	Full	-	340	<b>600</b>	ns	
Driver Differential Output Skew	$t_{SKEW}$	$R_{DIFF} = 54\Omega, C_D = 50pF$ (Figure 4)	Full	-	1	<b>30</b>	ns	
Driver Differential Rise or Fall Time	$t_R, t_F$	$R_{DIFF} = 54\Omega, C_D = 50pF$ (Figure 4)	Full	<b>200</b>	400	<b>1000</b>	ns	
Driver Enable to Output High	$t_{ZH}$	$R_L = 1k\Omega, C_L = 50pF, SW = GND$ (Figure 5), (Note 9)	Full	-	-	<b>1000</b>	ns	
Driver Enable to Output Low	$t_{ZL}$	$R_L = 1k\Omega, C_L = 50pF, SW = V_{CC}$ (Figure 5), (Note 9)	Full	-	-	<b>1000</b>	ns	
Driver Disable from Output High	$t_{HZ}$	$R_L = 1k\Omega, C_L = 50pF, SW = GND$ (Figure 5)	Full	-	-	<b>150</b>	ns	
Driver Disable from Output Low	$t_{LZ}$	$R_L = 1k\Omega, C_L = 50pF, SW = V_{CC}$ (Figure 5)	Full	-	-	<b>150</b>	ns	
Driver Enable from Shutdown to Output High	$t_{ZH(SHDN)}$	$R_L = 1k\Omega, C_L = 50pF, SW = GND$ (Figure 5), (Notes 11, 12)	Full	-	-	<b>10</b>	$\mu s$	

# ISL32600E, ISL32601E, ISL32602E, ISL32603E

**Electrical Specifications ISL32600E, ISL32601E:** Test Conditions:  $V_{CC} = 2.7V$  to  $3.6V$ ; Typical values are at  $V_{CC} = 3V$ ,  $T_A = +25^\circ C$ ; Unless Otherwise Specified. **Boldface limits apply over the operating temperature range.** (Note 6) (Continued)

PARAMETER	SYMBOL	TEST CONDITIONS	TEMP (°C)	MIN (Note 15)	TYP	MAX (Note 15)	UNITS
Driver Enable from Shutdown to Output Low	$t_{ZL(SHDN)}$	$R_L = 1k\Omega$ , $C_L = 50pF$ , $SW = V_{CC}$ (Figure 5), (Notes 11, 12)	Full	-	-	<b>10</b>	$\mu s$
Time to Shutdown	$t_{SHDN}$	(Note 11)	Full	<b>50</b>	-	<b>600</b>	ns
Receiver Input to Output Delay	$t_{PLH}$ , $t_{PHL}$	(Figure 7)	Full	-	750	<b>1300</b>	ns
Receiver Skew   $t_{PLH} - t_{PHL}$	$t_{SKD}$	(Figure 7)	Full	-	115	<b>300</b>	ns
Receiver Enable to Output High	$t_{ZH}$	$R_L = 1k\Omega$ , $C_L = 15pF$ , $SW = GND$ (Figure 8), (Note 10)	Full	-	-	<b>50</b>	ns
Receiver Enable to Output Low	$t_{ZL}$	$R_L = 1k\Omega$ , $C_L = 15pF$ , $SW = V_{CC}$ (Figure 8), (Note 10)	Full	-	-	<b>50</b>	ns
Receiver Disable from Output High	$t_{HZ}$	$R_L = 1k\Omega$ , $C_L = 15pF$ , $SW = GND$ (Figure 8)	Full	-	12	<b>50</b>	ns
Receiver Disable from Output Low	$t_{LZ}$	$R_L = 1k\Omega$ , $C_L = 15pF$ , $SW = V_{CC}$ (Figure 8)	Full	-	13	<b>50</b>	ns
Receiver Enable from Shutdown to Output High	$t_{ZH(SHDN)}$	$R_L = 1k\Omega$ , $C_L = 15pF$ , $SW = GND$ (Figure 8), (Notes 11, 13)	Full	-	-	<b>12</b>	$\mu s$
Receiver Enable from Shutdown to Output Low	$t_{ZL(SHDN)}$	$R_L = 1k\Omega$ , $C_L = 15pF$ , $SW = V_{CC}$ (Figure 8), (Notes 11, 13)	Full	-	-	<b>12</b>	$\mu s$

**NOTES:**

- All currents into device pins are positive; all currents out of device pins are negative. All voltages are referenced to device ground unless otherwise specified.
- Supply current specification is valid for loaded drivers when  $DE = 0V$ .
- Applies to peak current. See "Typical Performance Curves" starting on page 14 for more information.
- When testing this parameter, keep  $\overline{RE} = 0$  to prevent the device from entering SHDN.
- When testing this parameter, the  $\overline{RE}$  signal high time must be short enough (typically  $<100ns$ ) to prevent the device from entering SHDN.
- Devices are put into shutdown by bringing  $\overline{RE}$  high and  $DE$  low. If the inputs are in this state for less than 50ns, the parts are guaranteed not to enter shutdown. If the inputs are in this state for at least 600ns (1200ns if  $V_{CC}=1.8V$ ), the parts are guaranteed to have entered shutdown. See "Low Power Shutdown Mode" on page 13.
- Keep  $\overline{RE} = V_{CC}$ , and set the  $DE$  signal low time  $>600ns$  (1200ns if  $V_{CC}=1.8V$ ) to ensure that the device enters SHDN.
- Set the  $\overline{RE}$  signal high time  $>600ns$  (1200ns if  $V_{CC}=1.8V$ ) to ensure that the device enters SHDN.
- If the Tx or Rx enable function isn't needed, connect the enable pin to the appropriate supply (see "Pin Descriptions" on page 3).
- Compliance to data sheet limits is assured by one or more methods: production test, characterization and/or design.

**Electrical Specifications ISL32602E, ISL32603E:** Test Conditions:  $V_{CC} = 1.8V$  to  $3.6V$ ; Typical values are at  $V_{CC} = 1.8V$ ,  $T_A = +25^\circ C$ ; Unless Otherwise Specified. **Boldface limits apply over the operating temperature range.** (Note 6)

PARAMETER	SYMBOL	TEST CONDITIONS	TEMP (°C)	MIN (Note 15)	TYP	MAX (Note 15)	UNITS	
<b>DC CHARACTERISTICS</b>								
Driver Differential $V_{OUT}$	$V_{OD}$	$R_L = 100\Omega$ (RS-422) (Figure 3A)	$V_{CC} = 1.8V$	Full	<b>0.8</b>	0.9	-	V
			$V_{CC} \geq 3.15V$	Full	<b>1.95</b>	2.25	-	V
		No Load, $V_{CC} = 1.8V$		Full	<b>1.1</b>	1.4	$V_{CC}$	
		$R_L = 54\Omega$ (RS-485) (Figure 3A, $V_{CC} \geq 3V$ )		Full	<b>1.5</b>	1.95	-	V
		$R_L = 60\Omega$ , $-7V \leq V_{CM} \leq 12V$ (Figure 3B, $V_{CC} \geq 3V$ )		Full	<b>1.3</b>	-	-	V
Change in Magnitude of Driver Differential $V_{OUT}$ for Complementary Output States	$\Delta V_{OD}$	$R_L = 100\Omega$ (Figure 3A)		Full	-	0.01	<b>0.2</b>	V
Driver Common-Mode $V_{OUT}$	$V_{OC}$	$R_L = 100\Omega$ (Figure 3A)		Full	-	-	<b>3</b>	V

# ISL32600E, ISL32601E, ISL32602E, ISL32603E

**Electrical Specifications ISL32602E, ISL32603E:** Test Conditions:  $V_{CC} = 1.8V$  to  $3.6V$ ; Typical are at  $V_{CC} = 1.8V$ ,  $T_A = +25^\circ C$ ; Unless Otherwise Specified. **Boldface limits apply over the operating temperature range.** (Note 6) (Continued)

PARAMETER	SYMBOL	TEST CONDITIONS	TEMP (°C)	MIN (Note 15)	TYP	MAX (Note 15)	UNITS	
Change in Magnitude of Driver Common-Mode $V_{OUT}$ for Complementary Output States	$\Delta V_{OC}$	$R_L = 100\Omega$ (Figure 3A)	Full	-	0.01	<b>0.2</b>	V	
Output Leakage Current (Y, Z) (Full Duplex Versions Only)	$I_{OZD}$	$DE = 0V, V_{CC} = 0V$ $(-7V \leq V_{IN} \leq 12V)$ or $1.8V$ or $3V \leq V_{CC} \leq 3.6V$	$V_{OUT} = 12V (V_{CC} \geq 3V)$	Full	-	<b>1</b>	<b>60</b>	$\mu A$
			$V_{OUT} = 10V (V_{CC} = 1.8V)$	Full	-	<b>1</b>	<b>60</b>	$\mu A$
			$V_{OUT} = -7V$	Full	<b>-30</b>	-10	-	$\mu A$
Driver Short-Circuit Current, $V_O =$ High or Low	$I_{OSD}$	$DE = V_{CC}, -7V \leq V_Y$ or $V_Z \leq 12V (3.0V \leq V_{CC} \leq 3.6V)$ or $-7V \leq V_Y$ or $V_Z \leq 10V (V_{CC} = 1.8V)$ (Note 8)	Full	-	-	<b><math>\pm 250</math></b>	mA	
Logic Input High Voltage	$V_{IH}$	DI, DE, $\overline{RE}$	$V_{CC} \geq 1.8V$	Full	<b>1.26</b>	-	-	V
			$V_{CC} \geq 3V$	Full	<b>2</b>	-	-	V
Logic Input Low Voltage	$V_{IL}$	DI, DE, $\overline{RE}$	$V_{CC} \geq 1.8V$	Full	-	-	<b>0.4</b>	V
			$V_{CC} \geq 3V$	Full	-	-	<b>0.8</b>	V
Logic Input Current	$I_{IN1}$	DI = DE = $\overline{RE} = 0V$ or $V_{CC}$ (Note 14)	Full	<b>-1</b>	-	<b>1</b>	$\mu A$	
Input Current (A, B, A/Y, B/Z)	$I_{IN2}$	$DE = 0V, V_{CC} = 0V$ $(-7V \leq V_{IN} \leq 12V)$ or $1.8V$ or $3V \leq V_{CC} \leq 3.6V$	$V_{IN} = 12V$ (A, B Only)	Full	-	80	<b>125</b>	$\mu A$
			$V_{IN} = 12V (V_{CC} \geq 3V$ for A/Y, B/Z)	Full	-	80	<b>125</b>	$\mu A$
			$V_{IN} = 10V (V_{CC} = 1.8V$ for A/Y, B/Z)	Full	-	80	<b>125</b>	$\mu A$
			$V_{IN} = -7V$	Full	<b>-100</b>	-50	-	$\mu A$
Receiver Differential Threshold Voltage	$V_{TH}$	$-7V \leq V_Y$ or $V_Z \leq 2V$ at $V_{CC} = 1.8V$ or $-7V \leq V_Y$ or $V_Z \leq 12V$ at $V_{CC} \geq 3V$	Full	<b>-200</b>	0	<b>200</b>	mV	
Receiver Input Hysteresis	$\Delta V_{TH}$	$-7V \leq V_Y$ or $V_Z \leq 2V$ at $V_{CC} = 1.8V$ or $-7V \leq V_Y$ or $V_Z \leq 12V$ at $V_{CC} \geq 3V$	Full	-	65	-	mV	
Receiver Output High Voltage	$V_{OH}$	$I_O = -1mA, V_{ID} = 200mV$	Full	<b><math>V_{CC} - 0.4</math></b>	-	-	V	
Receiver Output Low Voltage	$V_{OL}$	$I_O = 2.2mA, V_{ID} = -200mV$	Full	-	-	<b>0.4</b>	V	
Three-State (high impedance) Receiver Output Current	$I_{OZR}$	$0V \leq V_O \leq V_{CC}, \overline{RE} = V_{CC}$	Full	<b>-1</b>	-	<b>1</b>	$\mu A$	
Receiver Short-Circuit Current	$I_{OSR}$	$0V \leq V_O \leq V_{CC}$	Full	-	-	<b><math>\pm 60</math></b>	mA	
<b>SUPPLY CURRENT</b>								
No-Load Supply Current (Note 7)	$I_{CC}$	DI = $0V$ or $V_{CC}$ , DE = $V_{CC}$ , $\overline{RE} = 0V$ or $V_{CC}$	$V_{CC} = 1.8V$	Full	-	105	<b>150</b>	$\mu A$
			$V_{CC} = 3.6V$	Full	-	150	<b>350</b>	$\mu A$
		DI = $0V$ or $V_{CC}$ , Rx Only (DE = $0V$ , $\overline{RE} = 0V$ )	$V_{CC} = 1.8V$	Full	-	90	<b>115</b>	$\mu A$
			$V_{CC} = 3.6V$	Full	-	125	<b>260</b>	$\mu A$
Shutdown Supply Current	$I_{SHDN}$	DE = $0V, \overline{RE} = V_{CC}, DI = 0V$ or $V_{CC}$	Full	-	-	<b>1</b>	$\mu A$	
<b>ESD PERFORMANCE</b>								
RS-485 Pins (A, Y, B, Z, A/Y, B/Z)		IEC61000-4-2, Air-Gap Discharge Method	25	-	$\pm 15$	-	kV	
		IEC61000-4-2, Contact Discharge Method	25	-	$\pm 8$	-	kV	
		Human Body Model, From Bus Pins to GND	25	-	$\pm 15$	-	kV	
All Pins		HBM, per MIL-STD-883 Method 3015	25	-	$\pm 8$	-	kV	
		Machine Model	25	-	400	-	V	



# ISL32600E, ISL32601E, ISL32602E, ISL32603E

**Electrical Specifications ISL32602E, ISL32603E:** Test Conditions:  $V_{CC} = 1.8V$  to  $3.6V$ ; Typicals are at  $V_{CC} = 1.8V$ ,  $T_A = +25^\circ C$ ; Unless Otherwise Specified. **Boldface limits apply over the operating temperature range.** (Note 6) (Continued)

PARAMETER	SYMBOL	TEST CONDITIONS	TEMP (°C)	MIN (Note 15)	TYP	MAX (Note 15)	UNITS	
<b>SWITCHING CHARACTERISTICS</b>								
Maximum Data Rate	$f_{MAX}$	(Figures 6, 7)	$V_{CC} = 1.8V, R_{DIFF} = \infty$	Full	<b>256</b>	-	-	kbps
			$V_{CC} \geq 3V, R_{DIFF} = 54\Omega$	Full	<b>460</b>	-	-	kbps
Driver Differential Output Delay	$t_{DD}$	$C_D = 50pF$ (Figure 4)	$V_{CC} = 1.8V, R_{DIFF} = \infty$	Full	-	750	<b>2600</b>	ns
			$V_{CC} \geq 3V, R_{DIFF} = 54\Omega$	Full	-	350	<b>1500</b>	ns
Driver Differential Output Skew	$t_{SKEW}$	$C_D = 50pF$ (Figure 4)	$V_{CC} = 1.8V, R_{DIFF} = \infty$	Full	-	120	<b>220</b>	ns
			$V_{CC} \geq 3V, R_{DIFF} = 54\Omega$	Full	-	2	<b>100</b>	ns
Driver Differential Rise or Fall Time	$t_R, t_F$	$C_D = 50pF$ (Figure 4)	$V_{CC} = 1.8V, R_{DIFF} = \infty$	Full	<b>150</b>	1700	<b>4500</b>	ns
			$V_{CC} \geq 3V, R_{DIFF} = 54\Omega$	Full	<b>200</b>	400	<b>900</b>	ns
Driver Enable to Output High	$t_{ZH}$	$R_L = 1k\Omega, C_L = 50pF, SW = GND$ (Figure 5), (Note 9)	Full	-	-	<b>3000</b>	ns	
Driver Enable to Output Low	$t_{ZL}$	$R_L = 1k\Omega, C_L = 50pF, SW = V_{CC}$ (Figure 5), (Note 9)	Full	-	-	<b>3000</b>	ns	
Driver Disable from Output High	$t_{HZ}$	$R_L = 1k\Omega, C_L = 50pF, SW = GND$ (Figure 5)	Full	-	-	<b>250</b>	ns	
Driver Disable from Output Low	$t_{LZ}$	$R_L = 1k\Omega, C_L = 50pF, SW = V_{CC}$ (Figure 5)	Full	-	-	<b>250</b>	ns	
Driver Enable from Shutdown to Output High	$t_{ZH(SHDN)}$	$R_L = 1k\Omega, C_L = 50pF, SW = GND$ (Figure 5), (Notes 11, 12)	Full	-	-	<b>3000</b>	ns	
Driver Enable from Shutdown to Output Low	$t_{ZL(SHDN)}$	$R_L = 1k\Omega, C_L = 50pF, SW = V_{CC}$ (Figure 5), (Notes 11, 12)	Full	-	-	<b>3000</b>	ns	
Time to Shutdown	$t_{SHDN}$	(Note 11)	Full	<b>50</b>	500	<b>1200</b>	ns	
Receiver Input to Output Delay	$t_{PLH}, t_{PHL}$	(Figure 7)	Full	-	180	<b>1000</b>	ns	
Receiver Skew   $t_{PLH} - t_{PHL}$	$t_{SKD}$	(Figure 7)	Full	-	35	<b>250</b>	ns	
Receiver Enable to Output High	$t_{ZH}$	$R_L = 1k\Omega, C_L = 15pF, SW = GND$ (Figure 8), (Note 10)	Full	-	-	<b>100</b>	ns	
Receiver Enable to Output Low	$t_{ZL}$	$R_L = 1k\Omega, C_L = 15pF, SW = V_{CC}$ (Figure 8), (Note 10)	Full	-	-	<b>100</b>	ns	
Receiver Disable from Output High	$t_{HZ}$	$R_L = 1k\Omega, C_L = 15pF, SW = GND$ (Figure 8)	Full	-	-	<b>75</b>	ns	
Receiver Disable from Output Low	$t_{LZ}$	$R_L = 1k\Omega, C_L = 15pF, SW = V_{CC}$ (Figure 8)	Full	-	-	<b>75</b>	ns	
Receiver Enable from Shutdown to Output High	$t_{ZH(SHDN)}$	$R_L = 1k\Omega, C_L = 15pF, SW = GND$ (Figure 8), (Notes 11, 13)	Full	-	-	<b>5500</b>	ns	
Receiver Enable from Shutdown to Output Low	$t_{ZL(SHDN)}$	$R_L = 1k\Omega, C_L = 15pF, SW = V_{CC}$ (Figure 8), (Notes 11, 13)	Full	-	-	<b>5500</b>	ns	

Test Circuits and Waveforms

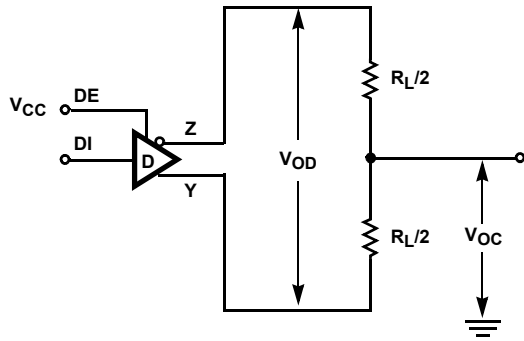

FIGURE 3A.  $V_{OD}$  AND  $V_{OC}$

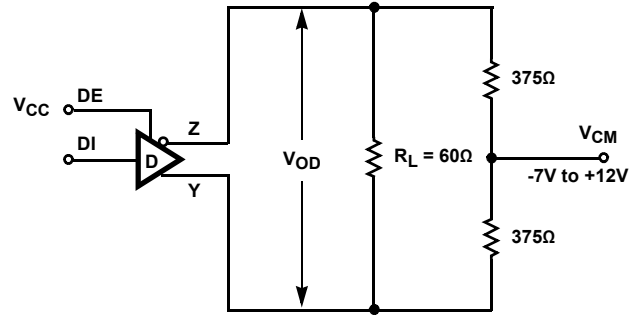

FIGURE 3B.  $V_{OD}$  WITH COMMON MODE LOAD

FIGURE 3. DC DRIVER TEST CIRCUITS

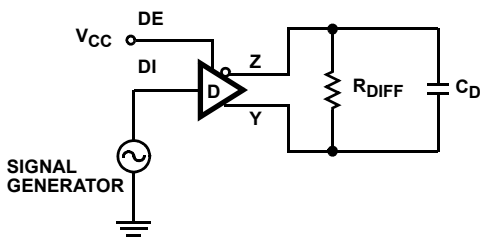

FIGURE 4A. TEST CIRCUIT

FIGURE 4. DRIVER PROPAGATION DELAY AND DIFFERENTIAL TRANSITION TIMES

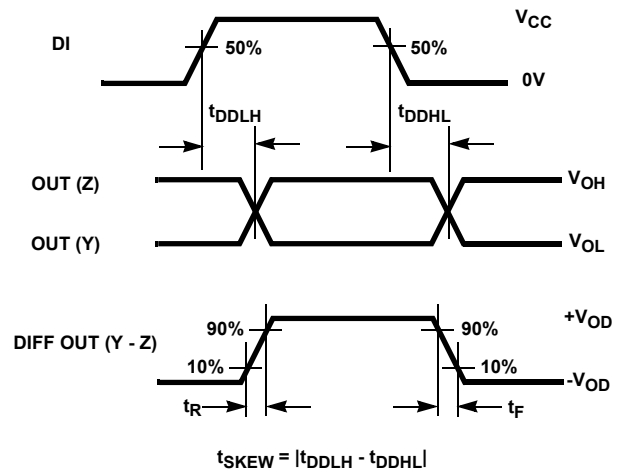

FIGURE 4B. MEASUREMENT POINTS

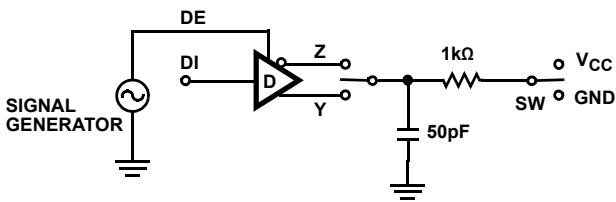

FIGURE 5A. TEST CIRCUIT

FIGURE 5. DRIVER ENABLE AND DISABLE TIMES

PARAMETER	OUTPUT	$\overline{RE}$	DI	SW
$t_{HZ}$	Y/Z	X	1/0	GND
$t_{LZ}$	Y/Z	X	0/1	$V_{CC}$
$t_{ZH}$	Y/Z	0 (Note 9)	1/0	GND
$t_{ZL}$	Y/Z	0 (Note 9)	0/1	$V_{CC}$
$t_{ZH}(SHDN)$	Y/Z	1 (Note 12)	1/0	GND
$t_{ZL}(SHDN)$	Y/Z	1 (Note 12)	0/1	$V_{CC}$

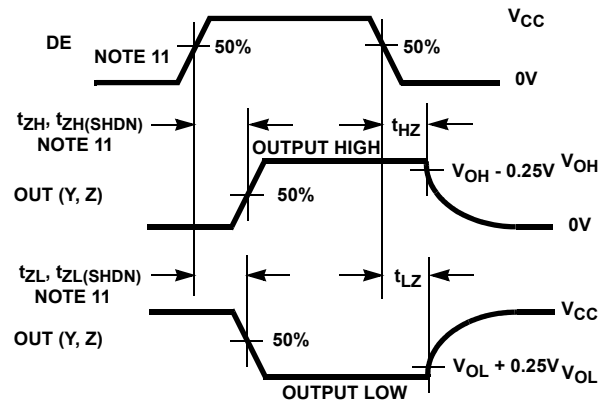

FIGURE 5B. MEASUREMENT POINTS

Test Circuits and Waveforms (Continued)

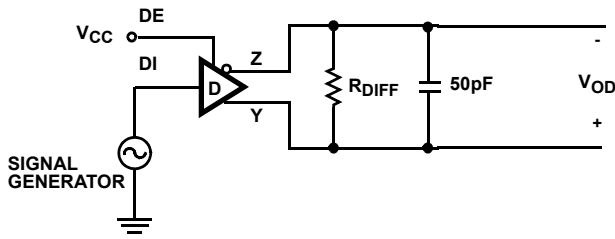

FIGURE 6A. TEST CIRCUIT

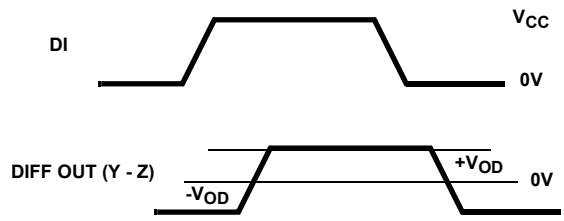

FIGURE 6B. MEASUREMENT POINTS

FIGURE 6. DRIVER DATA RATE

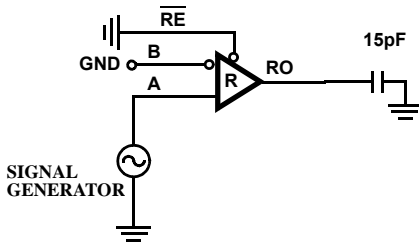

FIGURE 7A. TEST CIRCUIT

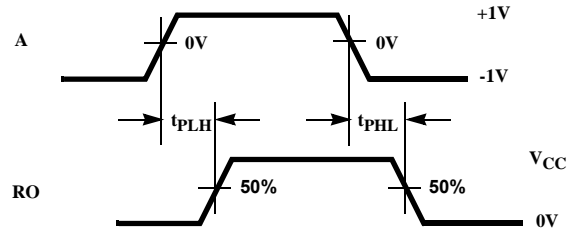

FIGURE 7B. MEASUREMENT POINTS

FIGURE 7. RECEIVER PROPAGATION DELAY AND DATA RATE

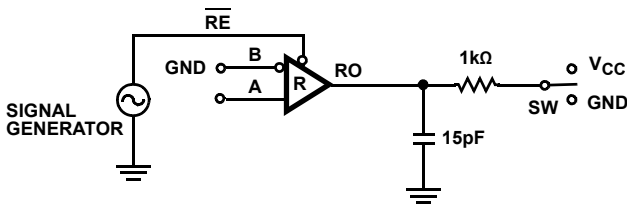

FIGURE 8A. TEST CIRCUIT

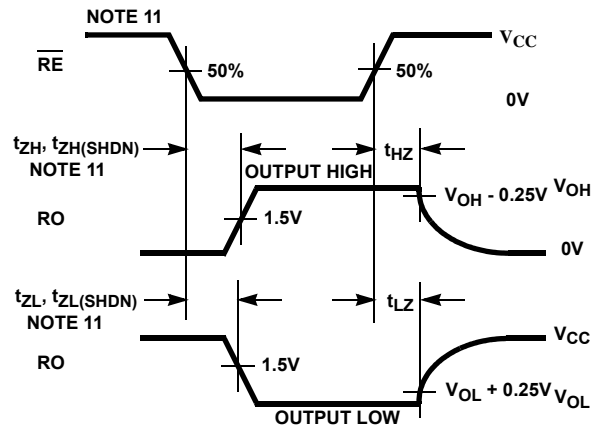

FIGURE 8B. MEASUREMENT POINTS

FIGURE 8. RECEIVER ENABLE AND DISABLE TIMES

PARAMETER	DE	A	SW
$t_{HZ}$	X	+1.5V	GND
$t_{LZ}$	X	-1.5V	$V_{CC}$
$t_{ZH}$ (Note 10)	0	+1.5V	GND
$t_{ZL}$ (Note 10)	0	-1.5V	$V_{CC}$
$t_{ZH(SHDN)}$ (Note 13)	0	+1.5V	GND
$t_{ZL(SHDN)}$ (Note 11)	0	-1.5V	$V_{CC}$

Application Information

RS-485 and RS-422 are differential (balanced) data transmission standards for use in long haul or noisy environments. RS-422 is a subset of RS-485, so RS-485 transceivers are also RS-422 compliant. RS-422 is a point-to-multipoint (multidrop) standard, which allows only one driver and up to 10 (assuming one unit load devices) receivers on each bus. RS-485 is a true multipoint standard, which allows up to 32 one-unit load devices (any combination of drivers and receivers) on each bus. To allow for multipoint operation, the RS-485 spec requires that drivers must handle bus contention without sustaining any damage.

Another important advantage of RS-485 is the extended common mode range (CMR), which specifies that the driver outputs and receiver inputs withstand signals that range from -7V to +12V. RS-422 and RS-485 are intended for runs as long as 4000', so the wide CMR is necessary to handle ground potential differences, as well as voltages induced in the cable by external fields.

Receiver Features

These devices utilize a differential input receiver for maximum noise immunity and common mode rejection. Input sensitivity is better than  $\pm 200mV$ , as required by the RS-422 and RS-485 specifications. The symmetrical  $\pm 200mV$  switching thresholds

eliminate the duty cycle distortion that occurs on receivers with full fail safe (FFS) functionality and with slowly transitioning input signals (see Figure 9). FFS receiver switching points have a

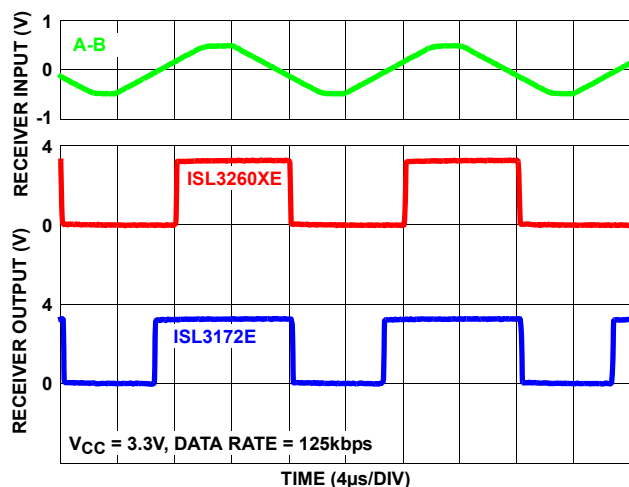

**FIGURE 9. COMPARED WITH A FULL-FAILSAFE ISL3172E RECEIVER, THE SYMMETRICAL RX THRESHOLDS OF THE ISL3260XE DELIVER LESS OUTPUT DUTY CYCLE DISTORTION WHEN DRIVEN WITH SLOW INPUT SIGNALS**

negative offset, so the RO high time is naturally longer than the low time. The ISL3260XE's larger receiver input sensitivity range enables an increase of the receiver input hysteresis. The 40mV to 65mV receiver hysteresis increases the noise immunity, which is a big advantage for noisy networks, or networks with slow bus transitions.

Receiver input resistance of 96k $\Omega$  surpasses the RS-422 spec of 4k $\Omega$  and is eight times the RS-485 "Unit Load (UL)" requirement of 12k $\Omega$  minimum. Thus, these products are known as "one-eighth UL" transceivers and there can be up to 256 of these devices on a network while still complying with the RS-485 loading specification.

Receiver inputs function with common mode voltages as great as +9V/-7V outside the power supplies (i.e., +12V and -7V) at  $V_{CC} = 3V$ , making them ideal for long networks where induced voltages and ground potential differences are realistic concerns. The positive CMR is limited to +2V when the ISL32602E or ISL32603E is operated with  $V_{CC} = 1.8V$ .

All the receivers include a "Fail-Safe if open" function that guarantees a high level receiver output if the receiver inputs are unconnected (floating). Because the Rx is not full failsafe, terminated networks may require bus biasing resistors (pull-up on noninverting input, pull-down on inverting input) to preserve the bus idle state when the bus is not actively driven.

Receivers operate at data rates from 128kbps to 460kbps - depending on the supply voltage - and all receiver outputs are tri-statable via the active low  $\overline{RE}$  input. There are no parasitic nor ESD diodes to  $V_{CC}$  on the  $\overline{RE}$  input, so it is tolerant of input voltages up to 5.5V, even with the ISL3260XE powered down (i.e.,  $V_{CC} = 0V$ ).

## Driver Features

These drivers are differential output devices that deliver at least 1.4V with  $V_{CC} \geq 3V$  across a 54 $\Omega$  load (RS-485) and at least 1.95V with  $V_{CC} \geq 3.15V$  across a 100 $\Omega$  load (RS-422). The 1.8V transmitters deliver a 1.1V unloaded, differential level. Drivers operate at data rates from 128kbps to 460kbps - depending on the supply voltage - and they feature low propagation delay skews to maximize bit width. Driver outputs are slew rate limited to minimize EMI and to reduce reflections in unterminated or improperly terminated networks.

All drivers are tri-statable via the active high DE input. There are no parasitic nor ESD diodes to  $V_{CC}$  on the DI and DE inputs, so these inputs are tolerant of input voltages up to 5.5V, even with the ISL3260XE powered down (i.e.,  $V_{CC} = 0V$ ).

## 1.8V Operation

The ISL32602E and ISL32603E are specifically designed to operate with supply voltages as low as 1.8V. Termination resistors should be avoided at this operating condition, and the unterminated driver is guaranteed to deliver a healthy 1.1V differential output voltage. This low supply voltage limits the +CMR to +2V, but the CMR increases as  $V_{CC}$  increases.

To get good 1.8V operation, the ISL32602E and ISL32603E have to run at a higher operating current. Thus, their  $I_{CC}$  with  $V_{CC} = 3.3V$  is considerably higher than the  $I_{CC}$  of the ISL32600E and ISL32601E, which are optimized for low  $I_{CC}$  at 3.3V (see Figures 1 and 2).

## Hot Plug Function

When a piece of equipment powers up, there is a period of time where the processor or ASIC driving the RS-485 control lines (DE,  $\overline{RE}$ ) is unable to ensure that the RS-485 Tx and Rx outputs are kept disabled. If the equipment is connected to the bus, a driver activating prematurely during power up may crash the bus. To avoid this scenario, the ISL3260XE devices incorporate a "Hot Plug" function. During power up, circuitry monitoring  $V_{CC}$  ensures that the Tx and Rx outputs remain disabled for a period of time, regardless of the state of DE and  $\overline{RE}$ . This gives the processor/ASIC a chance to stabilize and drive the RS-485 control lines to the proper states.

## ESD Protection

All pins on these devices include class 3 (>8kV) Human Body Model (HBM) ESD protection structures, but the RS-485 pins (driver outputs and receiver inputs) incorporate advanced structures allowing them to survive ESD events in excess of  $\pm 15kV$  HBM and  $\pm 15kV$  IEC61000. The RS-485 pins are particularly vulnerable to ESD damage because they typically connect to an exposed port on the exterior of the finished product. Simply touching the port pins, or connecting a cable, can cause an ESD event that might destroy unprotected ICs. These new ESD structures protect the device whether or not it is powered up, and without degrading the transceiver's common mode range. This built-in ESD protection eliminates the need for board level protection structures (e.g., transient suppression diodes), and the associated, undesirable capacitive load they present.

## IEC61000-4-2 Testing

The IEC61000 test method applies to finished equipment, rather than to an individual IC. Therefore, the pins most likely to suffer an ESD event are those that are exposed to the outside world (the RS-485 pins in this case), and the IC is tested in its typical application configuration (power applied) rather than testing each pin-to-pin combination. The lower current limiting resistor coupled with the larger charge storage capacitor yields a test that is much more severe than the HBM test. The extra ESD protection built into this device's RS-485 pins allows the design of equipment meeting level 4 criteria without the need for additional board level protection on the RS-485 port.

## AIR-GAP DISCHARGE TEST METHOD

For this test method, a charged probe tip moves toward the IC pin until the voltage arcs to it. The current waveform delivered to the IC pin depends on approach speed, humidity, temperature, etc. so it is difficult to obtain repeatable results. The ISL3260XE RS-485 pins withstand  $\pm 15\text{kV}$  air-gap discharges.

## CONTACT DISCHARGE TEST METHOD

During the contact discharge test, the probe contacts the tested pin before the probe tip is energized, thereby eliminating the variables associated with the air-gap discharge. The result is a more repeatable and predictable test, but equipment limits prevent testing devices at voltages higher than  $\pm 8\text{kV}$ . The ISL3260XE survive  $\pm 8\text{kV}$  contact discharges on the RS-485 pins.

## Data Rate, Cables, and Terminations

RS-485/422 are intended for network lengths up to 4000' (1220m), but the maximum system data rate decreases as the transmission length increases. The ISL32600E and ISL32601E operate at data rates up to 128kbps at the maximum (4000') distance, or at data rates of 256kbps for cable lengths less than 3000' (915m). The ISL32602E and ISL32603E, with  $V_{CC} = 1.8\text{V}$ , are limited to 1000' (305m) at 256kbps, or 2000' (610m) at 128kbps. With  $V_{CC} = 3.3\text{V}$ , the ISL32602E and ISL32603E deliver 460kbps over 2000', 256kbps over 3000', or 128kbps over 4000' cables.

Twisted pair is the cable of choice for RS-485/422 networks. Twisted pair cables tend to pick up noise and other electromagnetically induced voltages as common mode signals, which are effectively rejected by the differential receivers in these ICs.

Short networks using these transceivers need not be terminated, but terminations are recommended for 2.7V to 3.6V powered networks unless power dissipation is an overriding concern. Terminations are not recommended for 1.8V applications, due to the low drive available from those transmitters.

In point-to-point, or point-to-multipoint (single driver on bus) networks, the main cable should be terminated in its characteristic impedance (typically  $120\Omega$ ) at the end farthest from the driver. In multi-receiver applications, stubs connecting receivers to the main cable should be kept as short as possible. Multipoint (multi-driver) systems require that the

main cable be terminated in its characteristic impedance at both ends. Stubs connecting a transceiver to the main cable should be kept as short as possible.

Terminated networks using the ISL3260XE may require bus biasing resistors (pull-up on noninverting input, pull-down on inverting input) to preserve the bus idle state when the bus is not actively driven. Without bus biasing, the termination resistor collapses the undriven, differential bus voltage to 0V, which is an undefined level to the ISL3260XE Rx. Bus biasing forces a few hundred milli-volt positive differential voltage on the undriven bus, which all RS-485/422 Rx interpret as a valid logic high.

## Built-In Driver Overload Protection

As stated previously, the RS-485 spec requires that drivers survive worst case bus contentions undamaged. These devices meet this requirement via driver output short circuit current limits, and on-chip thermal shutdown circuitry.

The driver output stages incorporate short circuit current limiting circuitry that ensures that the output current never exceeds the RS-485 spec, even at the common mode voltage range extremes. Additionally, these devices utilize a foldback circuit which reduces the short circuit current, and thus the power dissipation, whenever the contending voltage exceeds either supply.

In the event of a major short circuit condition, these ICs also include a thermal shutdown feature that disables the drivers whenever the die temperature becomes excessive. This eliminates the power dissipation, allowing the die to cool. The drivers automatically re-enable after the die temperature drops by about  $20^\circ\text{C}$ . If the condition persists, the thermal shutdown / re-enable cycle repeats until the fault is cleared. Receivers remain operational during thermal shutdown.

## Low Power Shutdown Mode

These micro-power transceivers all use a fraction of the power required by their counterparts, but they also include a shutdown feature that reduces the already low quiescent  $I_{CC}$  to a 10nA trickle. These devices enter shutdown whenever the receiver and driver are *simultaneously* disabled ( $\overline{RE} = V_{CC}$  and  $DE = \text{GND}$ ) for a period of at least 600ns (1200ns at  $V_{CC} = 1.8\text{V}$ ). Disabling both the driver and the receiver for less than 50ns guarantees that the transceiver will not enter shutdown.

Note that most receiver and driver enable times increase when the transceiver enables from shutdown. Refer to Notes 9 through 13, at the end of the "Electrical Specification table" on page 7, for more information.

# ISL32600E, ISL32601E, ISL32602E, ISL32603E

**Typical Performance Curves**  $V_{CC} = 3V$  (ISL32600E, ISL32601E) or  $1.8V$  (ISL32602E, ISL32603E),  $T_A = +25^\circ C$ ; Unless Otherwise Specified

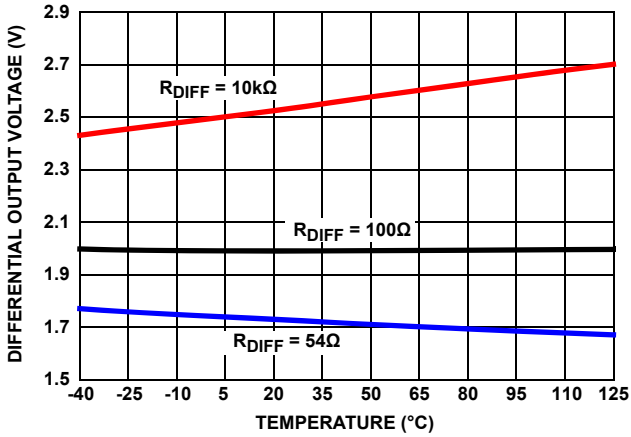

FIGURE 10. ISL32600E, ISL32601E DRIVER DIFFERENTIAL OUTPUT VOLTAGE vs TEMPERATURE

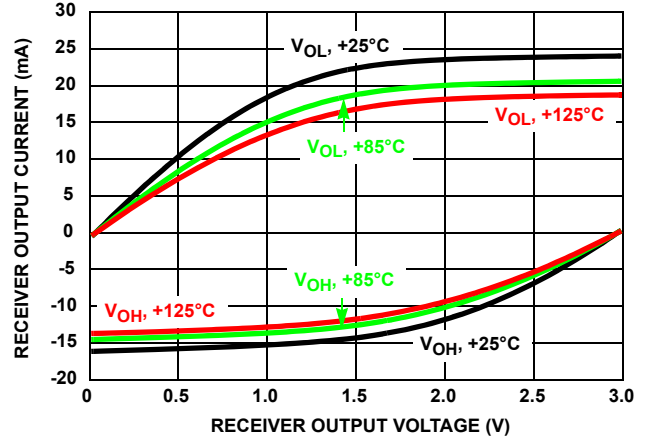

FIGURE 11. ISL32600E, ISL32601E RECEIVER OUTPUT CURRENT vs RECEIVER OUTPUT VOLTAGE

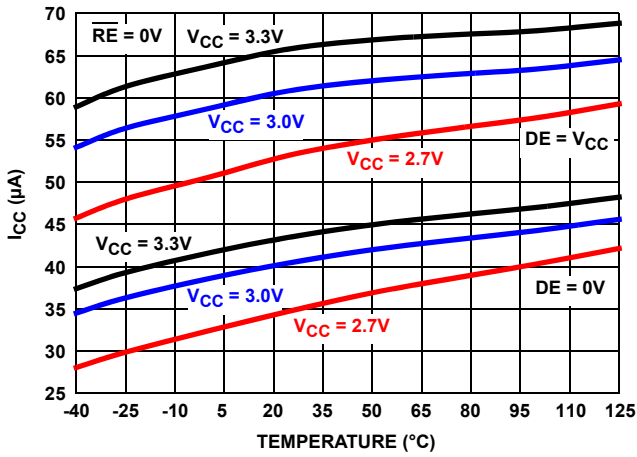

FIGURE 12. ISL32600E, ISL32601E STATIC SUPPLY CURRENT vs TEMPERATURE

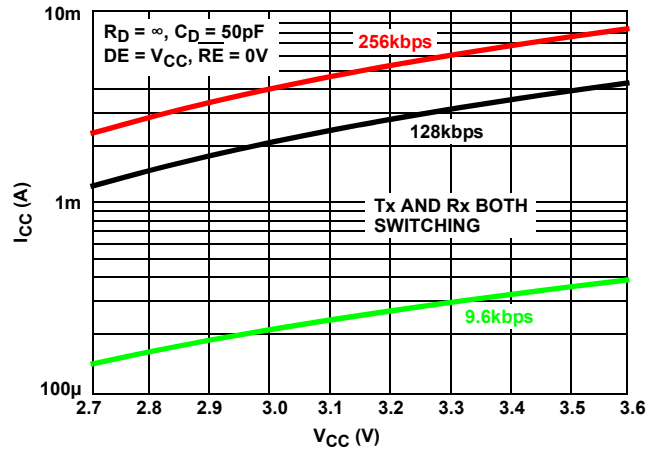

FIGURE 13. ISL32600E, ISL32601E DYNAMIC SUPPLY CURRENT vs SUPPLY VOLTAGE AT DIFFERENT DATA RATES

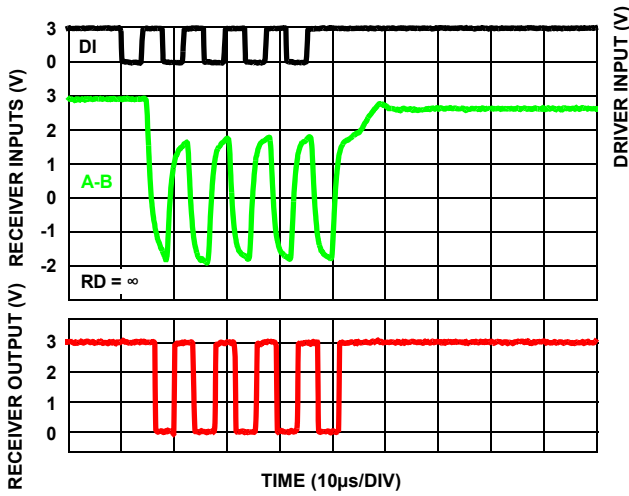

FIGURE 14. ISL32600E, ISL32601E PERFORMANCE WITH  $V_{CC} = 3V$ , 256kbps, 3000' (915m) CAT 5 CABLE

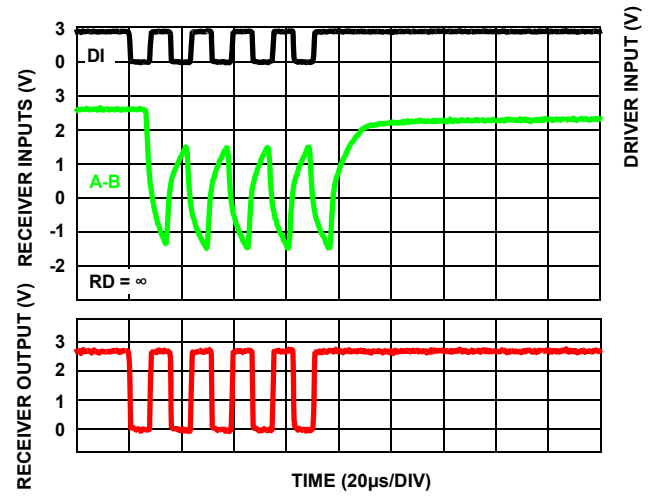

FIGURE 15. ISL32600E, ISL32601E PERFORMANCE WITH  $V_{CC} = 2.7V$ , 128kbps, 4000' (1220m) CAT 5 CABLE

# ISL32600E, ISL32601E, ISL32602E, ISL32603E

**Typical Performance Curves**  $V_{CC} = 3V$  (ISL32600E, ISL32601E) or  $1.8V$  (ISL32602E, ISL32603E),  $T_A = +25^\circ C$ ; Unless Otherwise Specified (Continued)

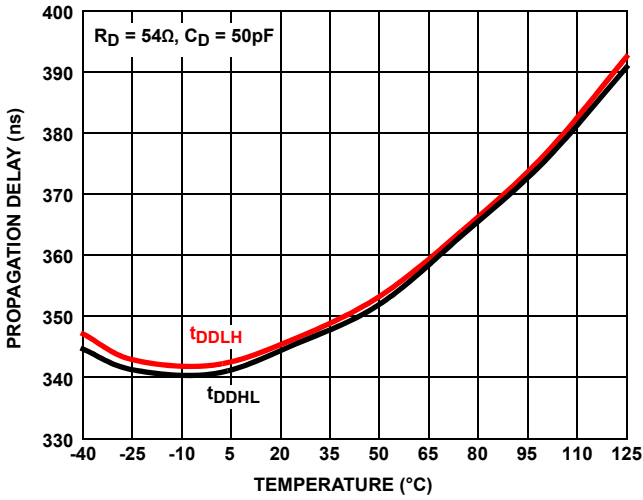

FIGURE 16. ISL32600E, ISL32601E DRIVER DIFFERENTIAL PROPAGATION DELAY vs TEMPERATURE

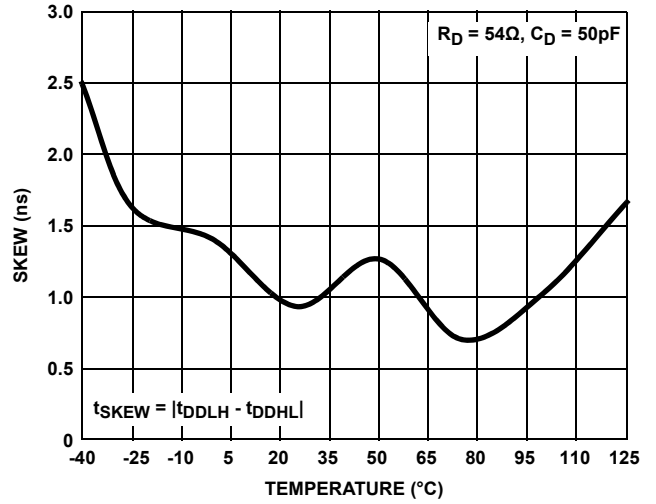

FIGURE 17. ISL32600E, ISL32601E DRIVER DIFFERENTIAL SKEW vs TEMPERATURE

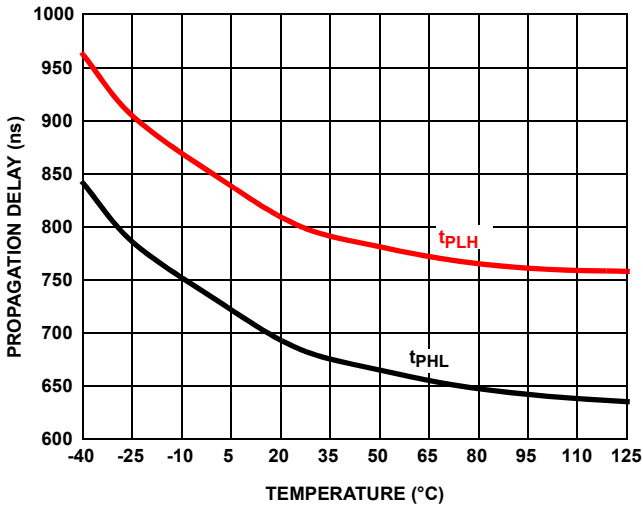

FIGURE 18. ISL32600E, ISL32601E RECEIVER PROPAGATION DELAY vs TEMPERATURE

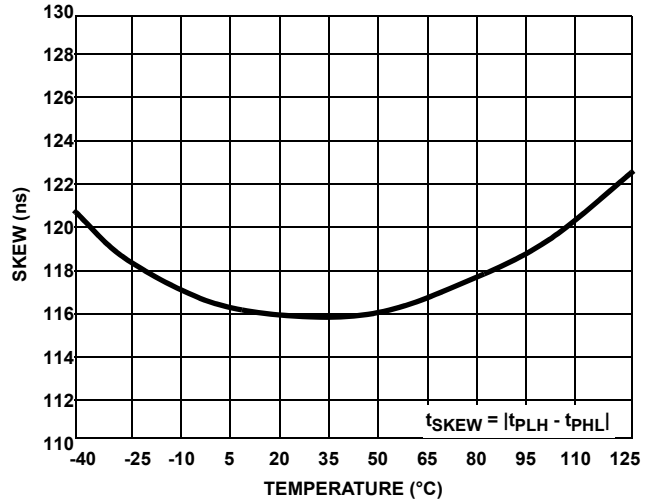

FIGURE 19. ISL32600E, ISL32601E RECEIVER SKEW vs TEMPERATURE

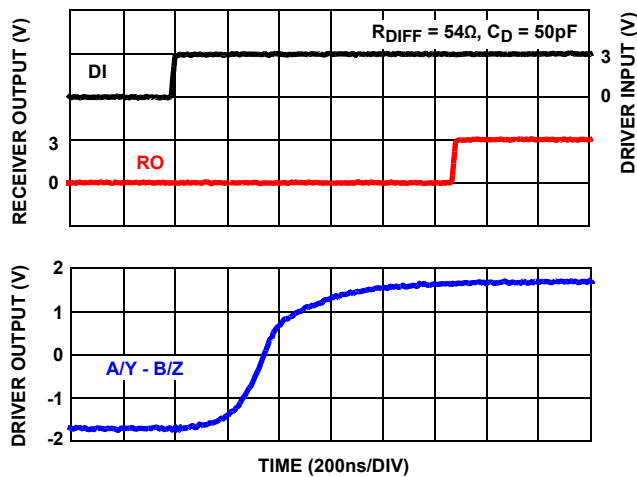

FIGURE 20. ISL32600E, ISL32601E DRIVER AND RECEIVER WAVEFORMS, LOW TO HIGH

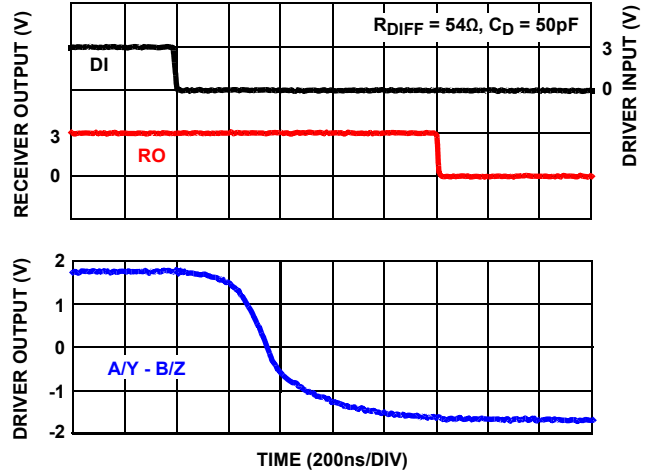

FIGURE 21. ISL32600E, ISL32601E DRIVER AND RECEIVER WAVEFORMS, HIGH TO LOW

# ISL32600E, ISL32601E, ISL32602E, ISL32603E

**Typical Performance Curves**  $V_{CC} = 3V$  (ISL32600E, ISL32601E) or  $1.8V$  (ISL32602E, ISL32603E),  $T_A = +25^\circ C$ ; Unless Otherwise Specified (Continued)

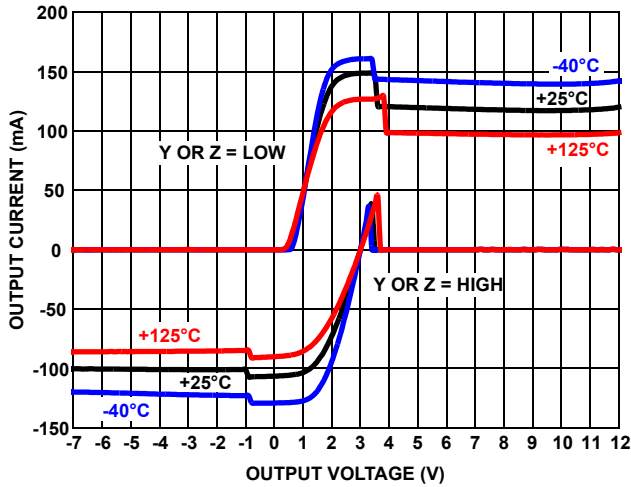

FIGURE 22. ISL32600E, ISL32601E DRIVER OUTPUT CURRENT vs SHORT CIRCUIT VOLTAGE

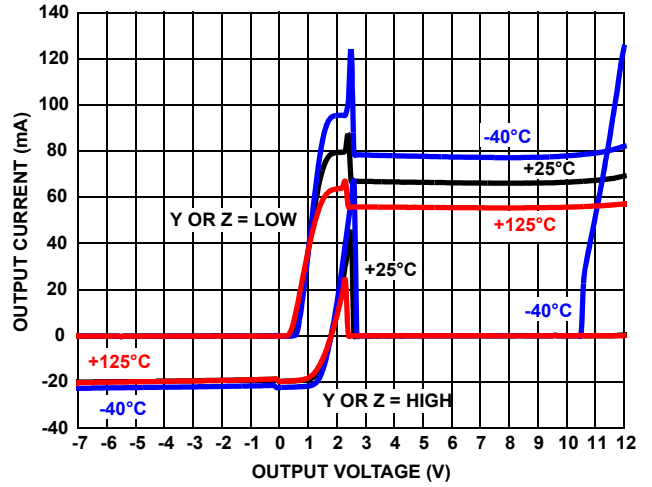

FIGURE 23. ISL32602E, ISL32603E DRIVER OUTPUT CURRENT vs SHORT CIRCUIT VOLTAGE

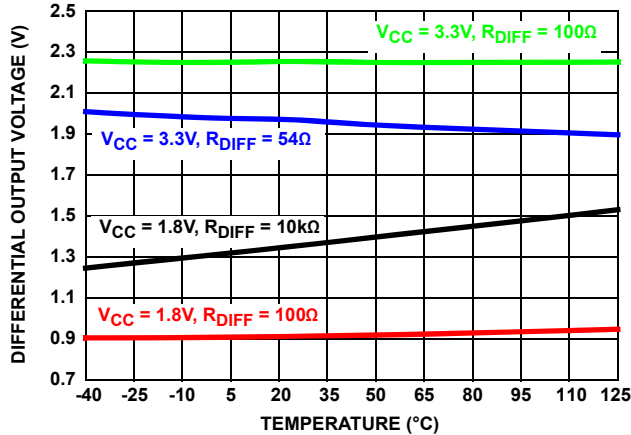

FIGURE 24. ISL32602E, ISL32603E DRIVER DIFFERENTIAL OUTPUT VOLTAGE vs TEMPERATURE

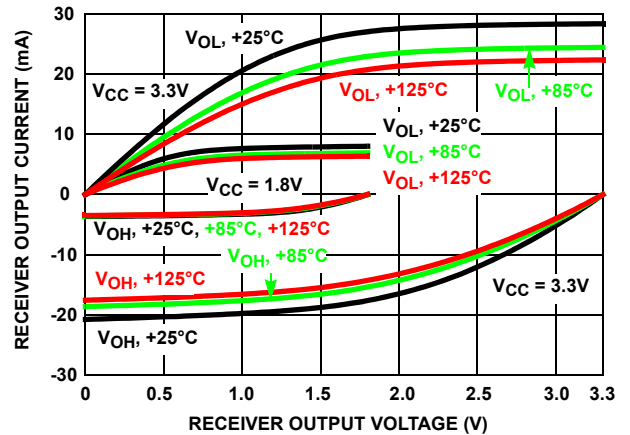

FIGURE 25. ISL32602E, ISL32603E RECEIVER OUTPUT CURRENT vs RECEIVER OUTPUT VOLTAGE

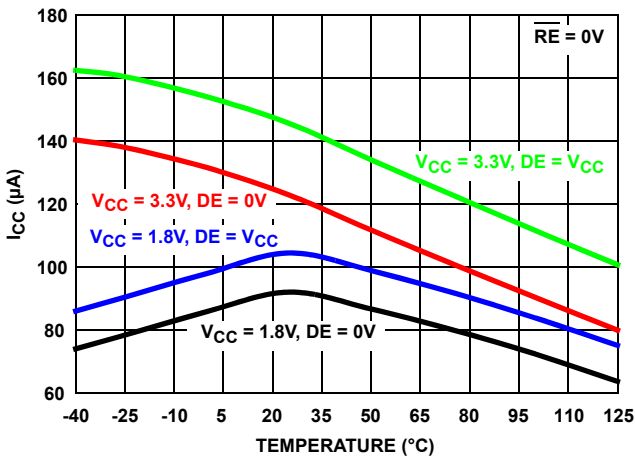

FIGURE 26. ISL32602E, ISL32603E STATIC SUPPLY CURRENT vs TEMPERATURE

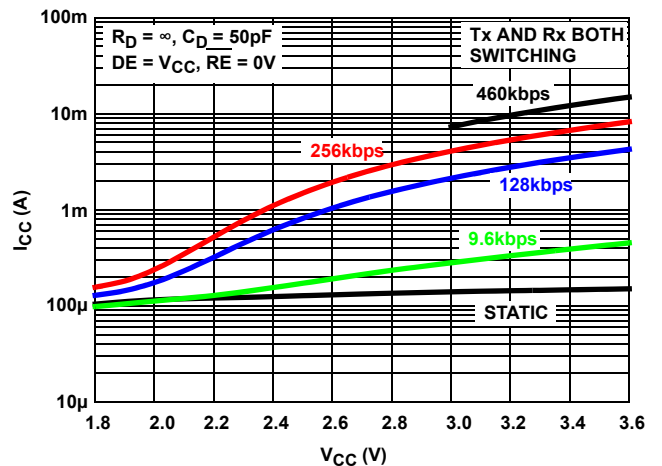

FIGURE 27. ISL32602E, ISL32603E DYNAMIC SUPPLY CURRENT vs SUPPLY VOLTAGE AT DIFFERENT DATA RATES



# ISL32600E, ISL32601E, ISL32602E, ISL32603E

**Typical Performance Curves**  $V_{CC} = 3V$  (ISL32600E, ISL32601E) or  $1.8V$  (ISL32602E, ISL32603E),  $T_A = +25^\circ C$ ; Unless Otherwise Specified (Continued)

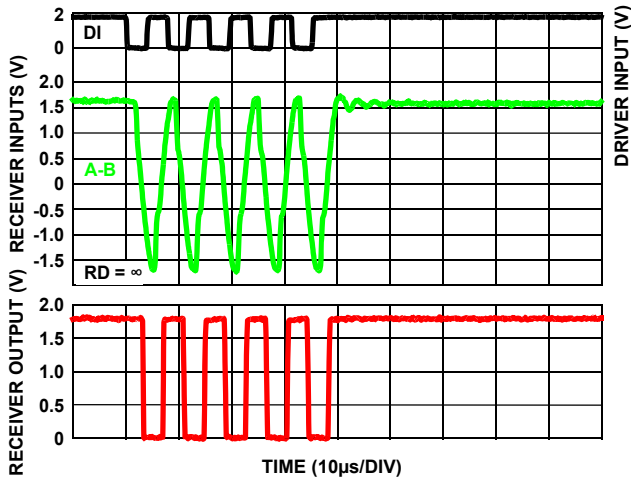

FIGURE 28. ISL32602E, ISL32603E PERFORMANCE WITH  $V_{CC} = 1.8V$ , 256kbps, 1000' (305m) CAT 5 CABLE

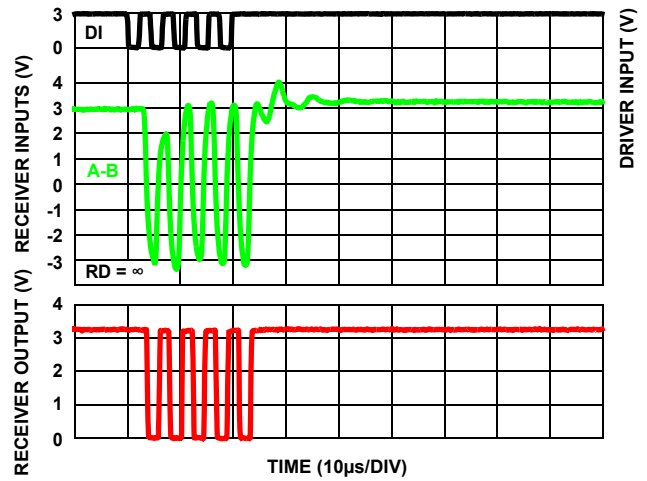

FIGURE 29. ISL32602E, ISL32603E PERFORMANCE WITH  $V_{CC} = 3.3V$ , 460kbps, 2000' (610m) CAT 5 CABLE

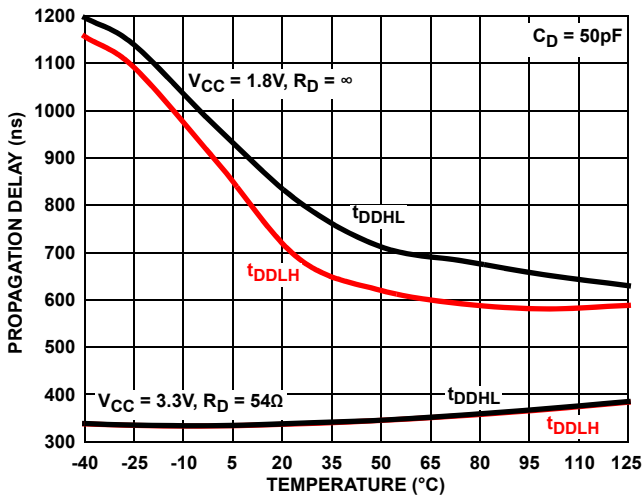

FIGURE 30. ISL32602E, ISL32603E DRIVER DIFFERENTIAL PROPAGATION DELAY vs TEMPERATURE

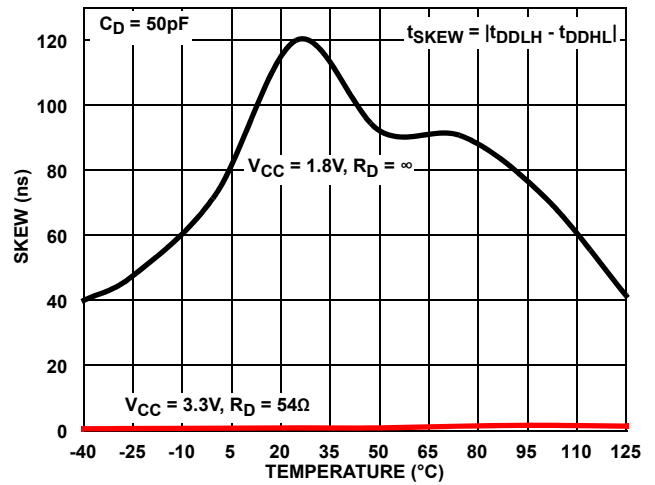

FIGURE 31. ISL32602E, ISL32603E DRIVER DIFFERENTIAL SKEW vs TEMPERATURE

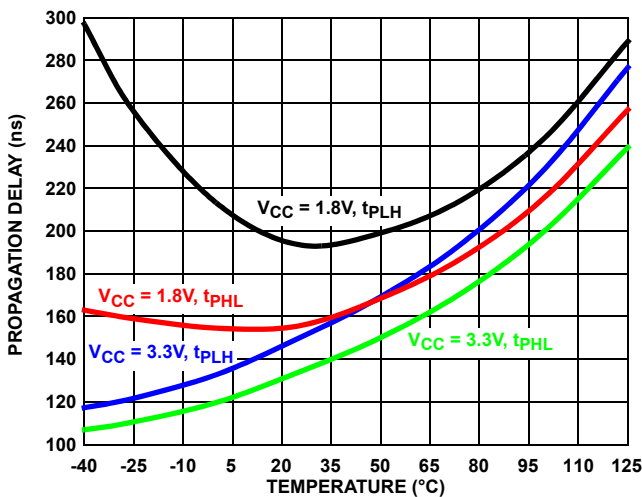

FIGURE 32. ISL32602E, ISL32603E RECEIVER PROPAGATION DELAY vs TEMPERATURE

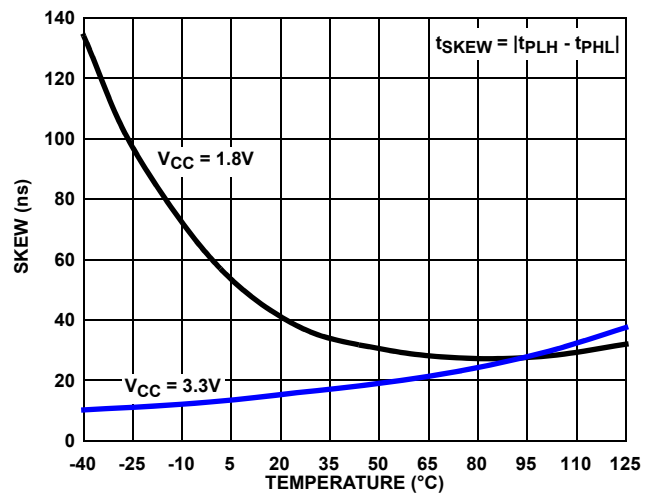

FIGURE 33. ISL32602E, ISL32603E RECEIVER SKEW vs TEMPERATURE

# ISL32600E, ISL32601E, ISL32602E, ISL32603E

**Typical Performance Curves**  $V_{CC} = 3V$  (ISL32600E, ISL32601E) or  $1.8V$  (ISL32602E, ISL32603E),  $T_A = +25^\circ C$ ; Unless Otherwise Specified (Continued)

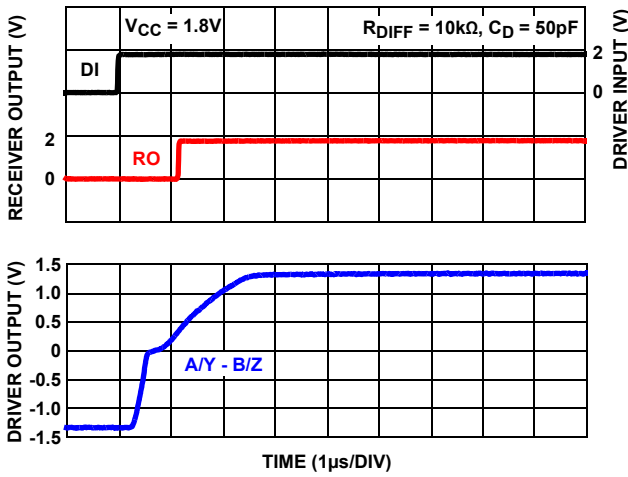

FIGURE 34. ISL32602E, ISL32603E DRIVER AND RECEIVER WAVEFORMS, LOW TO HIGH

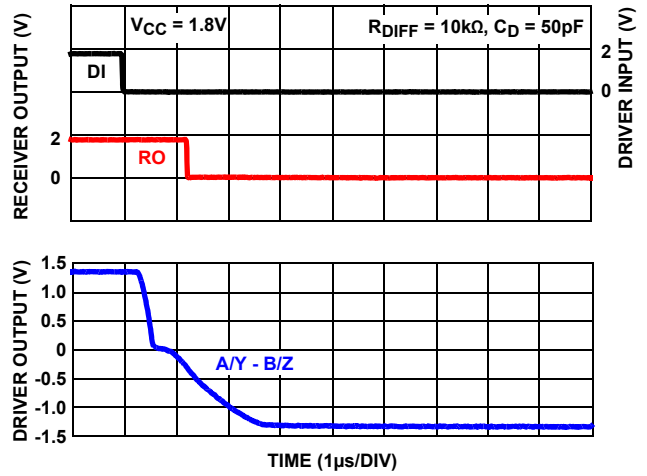

FIGURE 35. ISL32602E, ISL32603E DRIVER AND RECEIVER WAVEFORMS, HIGH TO LOW

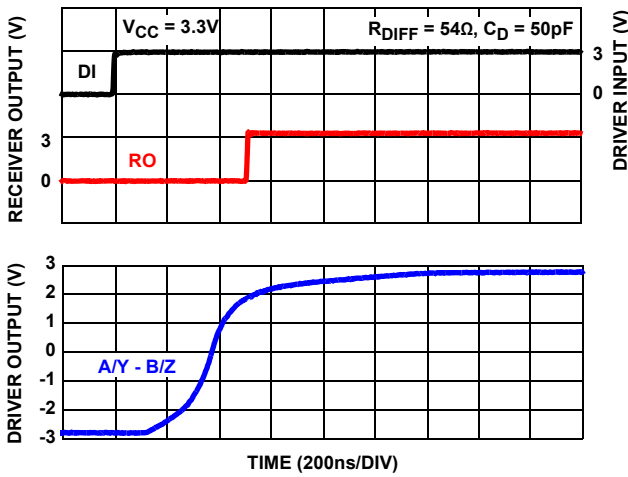

FIGURE 36. ISL32602E, ISL32603E DRIVER AND RECEIVER WAVEFORMS, LOW TO HIGH

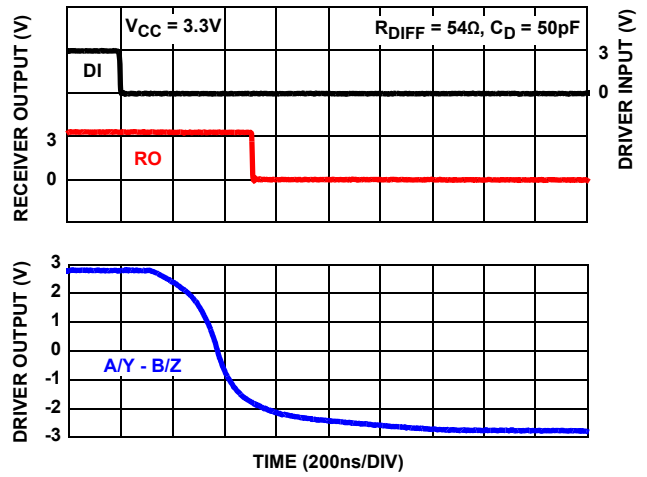

FIGURE 37. ISL32602E, ISL32603E DRIVER AND RECEIVER WAVEFORMS, HIGH TO LOW

## Die Characteristics

### SUBSTRATE POTENTIAL (POWERED UP):

GND

### PROCESS:

Si Gate BiCMOS

# ISL32600E, ISL32601E, ISL32602E, ISL32603E

## Revision History

The revision history provided is for informational purposes only and is believed to be accurate, but not warranted. Please go to web to make sure you have the latest revision.

DATE	REVISION	CHANGE
June 22, 2012	FN7967.0	Initial Release.

## Products

Intersil Corporation is a leader in the design and manufacture of high-performance analog semiconductors. The Company's products address some of the industry's fastest growing markets, such as, flat panel displays, cell phones, handheld products, and notebooks. Intersil's product families address power management and analog signal processing functions. Go to [www.intersil.com/products](http://www.intersil.com/products) for a complete list of Intersil product families.

For a complete listing of Applications, Related Documentation and Related Parts, please see the respective device information page on intersil.com: [ISL32600E](http://www.intersil.com/products), [ISL32601E](http://www.intersil.com/products), [ISL32602E](http://www.intersil.com/products), [ISL32603E](http://www.intersil.com/products)

To report errors or suggestions for this data sheet, please go to: [www.intersil.com/askourstaff](http://www.intersil.com/askourstaff)

FITs are available from our website at: <http://rel.intersil.com/reports/search.php>

For additional products, see [www.intersil.com/product\\_tree](http://www.intersil.com/product_tree)

Intersil products are manufactured, assembled and tested utilizing ISO9000 quality systems as noted in the quality certifications found at [www.intersil.com/design/quality](http://www.intersil.com/design/quality)

*Intersil products are sold by description only. Intersil Corporation reserves the right to make changes in circuit design, software and/or specifications at any time without notice. Accordingly, the reader is cautioned to verify that data sheets are current before placing orders. Information furnished by Intersil is believed to be accurate and reliable. However, no responsibility is assumed by Intersil or its subsidiaries for its use; nor for any infringements of patents or other rights of third parties which may result from its use. No license is granted by implication or otherwise under any patent or patent rights of Intersil or its subsidiaries.*

For information regarding Intersil Corporation and its products, see [www.intersil.com](http://www.intersil.com)

# Package Outline Drawing

M8.118

8 LEAD MINI SMALL OUTLINE PLASTIC PACKAGE

Rev 4, 7/11

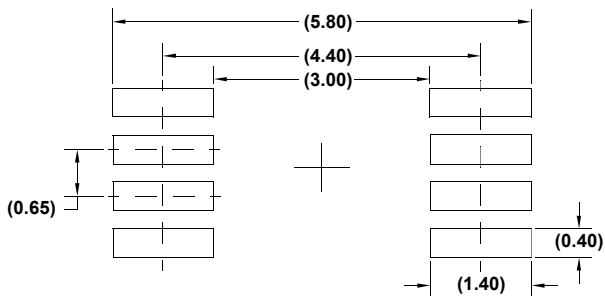
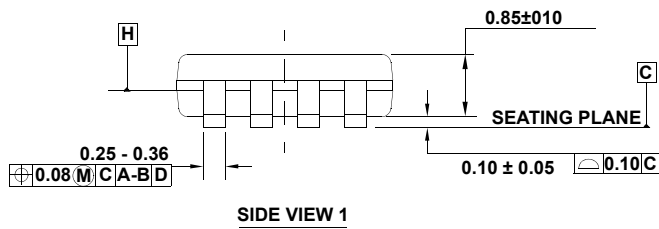
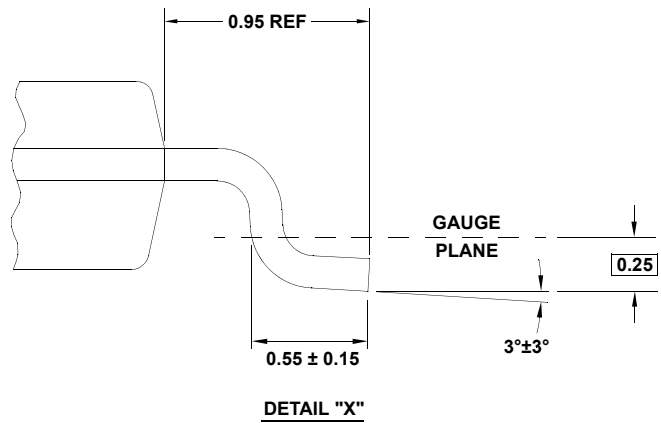
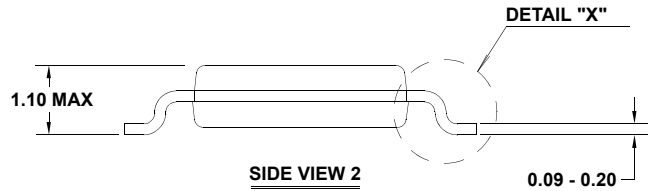
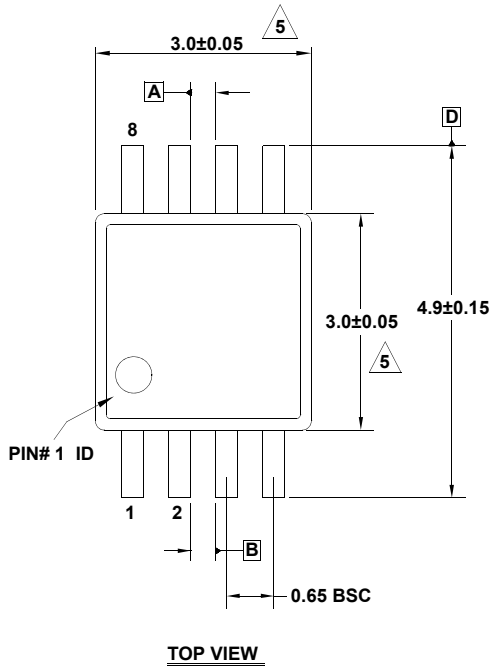

**NOTES:**

1. Dimensions are in millimeters.
2. Dimensioning and tolerancing conform to JEDEC MO-187-AA and AMSEY14.5m-1994.
3. Plastic or metal protrusions of 0.15mm max per side are not included.
4. Plastic interlead protrusions of 0.15mm max per side are not included.

5. Dimensions are measured at Datum Plane "H".

6. Dimensions in ( ) are for reference only.

# Package Outline Drawing

## M8.15

8 LEAD NARROW BODY SMALL OUTLINE PLASTIC PACKAGE

Rev 4, 1/12

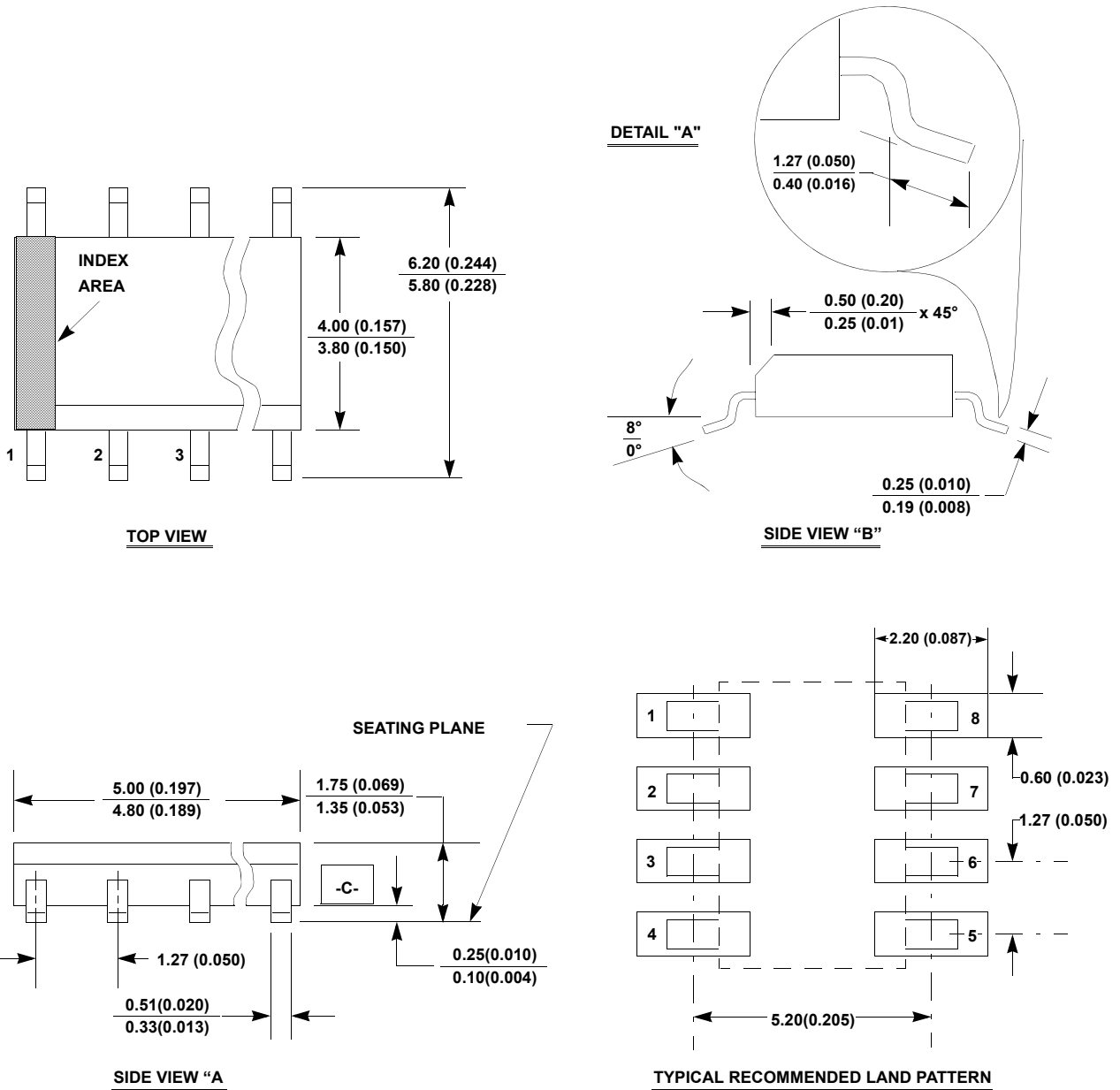

**NOTES:**

1. Dimensioning and tolerancing per ANSI Y14.5M-1994.
2. Package length does not include mold flash, protrusions or gate burrs. Mold flash, protrusion and gate burrs shall not exceed 0.15mm (0.006 inch) per side.
3. Package width does not include interlead flash or protrusions. Interlead flash and protrusions shall not exceed 0.25mm (0.010 inch) per side.
4. The chamfer on the body is optional. If it is not present, a visual index feature must be located within the crosshatched area.
5. Terminal numbers are shown for reference only.
6. The lead width as measured 0.36mm (0.014 inch) or greater above the seating plane, shall not exceed a maximum value of 0.61mm (0.024 inch).
7. Controlling dimension: MILLIMETER. Converted inch dimensions are not necessarily exact.
8. This outline conforms to JEDEC publication MS-012-AA ISSUE C.

# Package Outline Drawing

## M10.118

10 LEAD MINI SMALL OUTLINE PLASTIC PACKAGE

Rev 1, 4/12

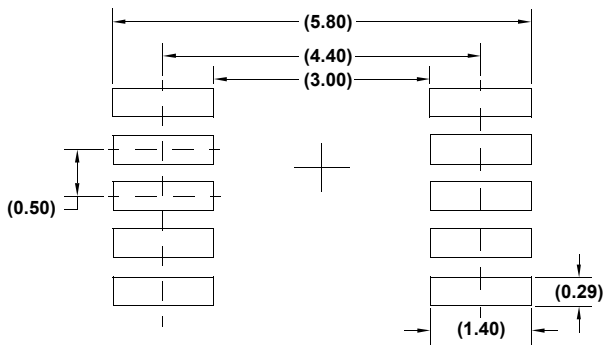
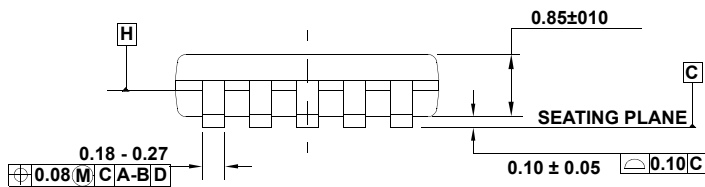
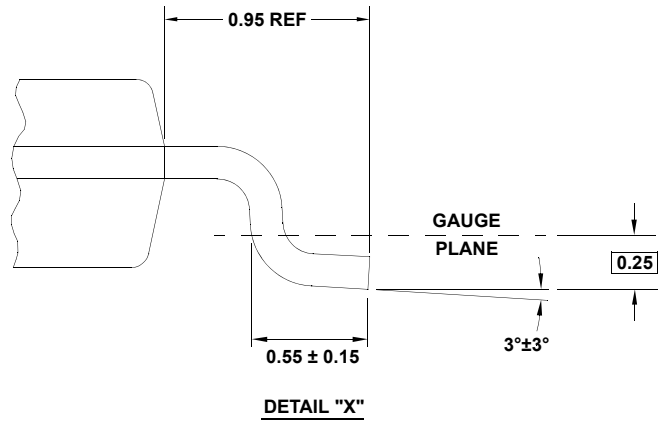
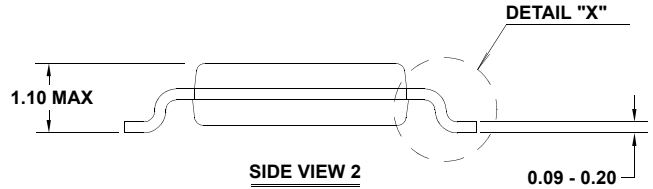
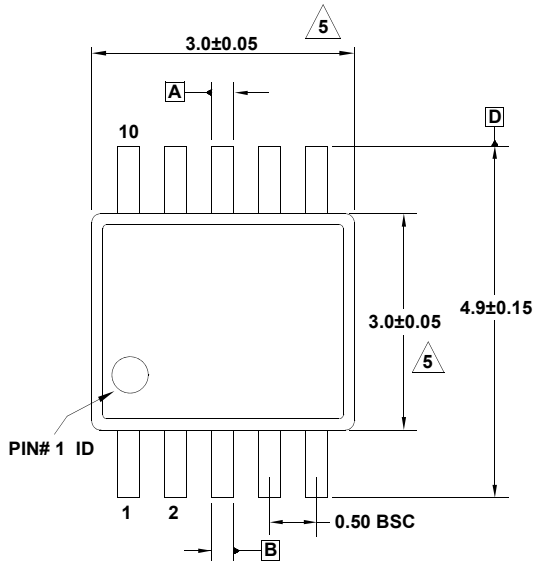

NOTES:

1. Dimensions are in millimeters.
2. Dimensioning and tolerancing conform to JEDEC MO-187-BA and AMSEY14.5m-1994.
3. Plastic or metal protrusions of 0.15mm max per side are not included.
4. Plastic interlead protrusions of 0.15mm max per side are not included.

5. Dimensions are measured at Datum Plane "H".

6. Dimensions in ( ) are for reference only.

# ISL32600E, ISL32601E, ISL32602E, ISL32603E

## Package Outline Drawing

### M14.15

14 LEAD NARROW BODY SMALL OUTLINE PLASTIC PACKAGE

Rev 1, 10/09

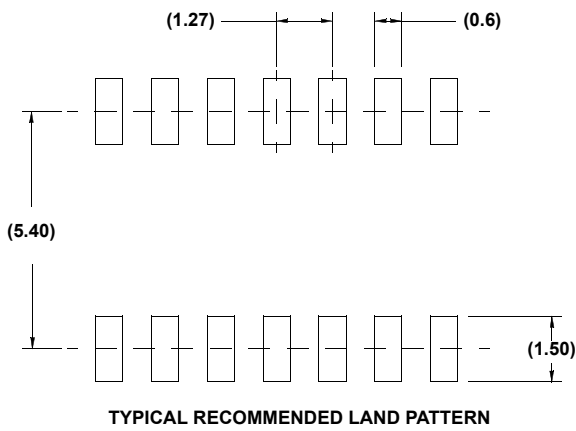
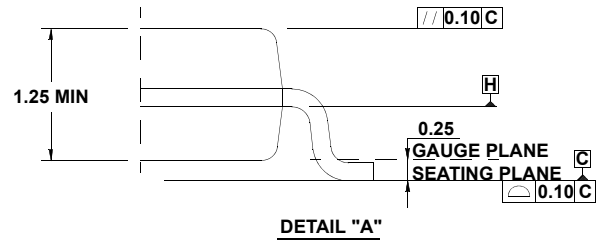
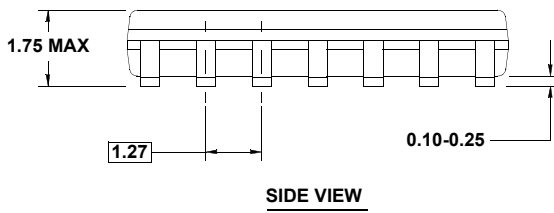
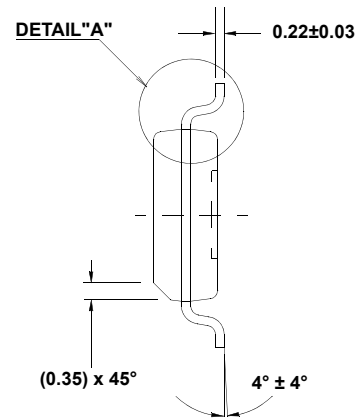
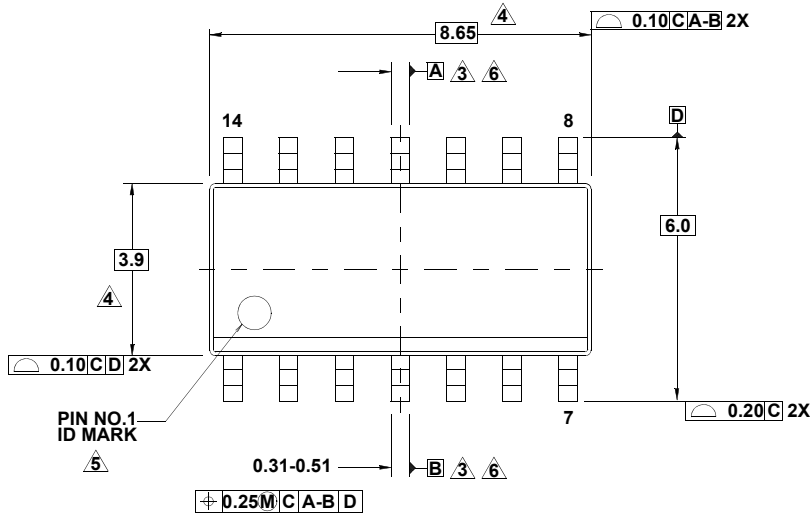

#### NOTES:

1. Dimensions are in millimeters.  
Dimensions in ( ) for Reference Only.
2. Dimensioning and tolerancing conform to AMSEY14.5m-1994.
3. Datums A and B to be determined at Datum H.
4. Dimension does not include interlead flash or protrusions.  
Interlead flash or protrusions shall not exceed 0.25mm per side.
5. The pin #1 identifier may be either a mold or mark feature.
6. Does not include dambar protrusion. Allowable dambar protrusion shall be 0.10mm total in excess of lead width at maximum condition.
7. Reference to JEDEC MS-012-AB.