

±16.5kV ESD Protected, +125°C, 3.0V to 5.5V, SOT-23/TDFN Packaged, 20Mbps, Full Fail-safe, Low Power, RS-485/RS-422 Receivers

The Intersil ISL3280E, ISL3281E, ISL3282E, ISL3283E, ISL3284E, ISL3285E are ±16.5kV IEC61000 ESD Protected, 3.0V to 5.5V powered, single receivers that meet both the RS-485 and RS-422 standards for balanced communication. These receivers have very low bus currents (+125µA-100µA), so they present a true “1/8 unit load” to the RS-485 bus. This allows up to 256 receivers on the network without violating the RS-485 specification’s 32 unit load maximum and without using repeaters.

Receiver inputs feature a “Full Fail-Safe” design, which ensures a logic high Rx output if Rx inputs are floating, shorted, or terminated but undriven.

The ISL3280E and ISL3284E feature an always enabled Rx; the ISL3281E and ISL3285E feature an active high Rx enable pin, and the ISL3282E and ISL3283E include an active low enable pin. All versions are offered in Industrial and Extended Industrial (-40°C to +125°C) temperature ranges.

A 26% smaller footprint is available with the ISL3282E and ISL3285E TDFN package. These devices, plus the ISL3284E, also feature a logic supply pin (V_L) that sets the V_{OH} level of the RO output (and the switching points of the RE / \overline{RE} input) to be compatible with another supply voltage in mixed voltage systems.

For companion single RS-485 transmitters in micro packages, please see the ISL3293E, ISL3294E, ISL3295E, ISL3296E, ISL3297E, ISL3298E data sheet.

Features

- IEC61000 ESD Protection on RS-485 Inputs . . . ±16.5kV
- Class 3 ESD Level on all Other Pins >5kV HBM
- Pb-Free (RoHS Compliant)
- Wide Supply Range 3.0V to 5.5V
- Specified for +125°C Operation
- Logic Supply Pin (V_L) Eases Operation in Mixed Supply Systems (ISL3282E, ISL3284E, ISL3285E Only)
- Full Fail-safe (Open, Short, Terminated/Undriven)
- True 1/8 Unit Load Allows up to 256 Devices on the Bus
- High Data Rates up to 20Mbps
- Low Quiescent Supply Current 500µA (Max)
- Very Low Shutdown Supply Current 20µA (Max)
- -7V to +12V Common Mode Input Voltage Range
- Tri-statable Rx Available (Active Low or High EN Input)
- 5V Tolerant Logic Inputs When V_{CC} ≤ 5V

Applications

- Clock Distribution
- High Node Count Systems
- Space Constrained Systems
- Security Camera Networks
- Building Environmental Control/Lighting Systems
- Industrial/Process Control Networks

TABLE 1. SUMMARY OF FEATURES

PART NUMBER	FUNCTION	DATA RATE (Mbps)	# DEVICES ON BUS	RX ENABLE?	V _L PIN?	QUIESCENT I _{CC} (µA)	LOW POWER SHUTDOWN?	LEAD COUNT
ISL3280E	1 Rx	20	256	NO	NO	350	NO	5-SOT
ISL3281E	1 Rx	20	256	ACTIVE HIGH	NO	350	YES	6-SOT
ISL3282E	1 Rx	20	256	ACTIVE LOW	YES	350	YES	8-TDFN
ISL3283E	1 Rx	20	256	ACTIVE LOW	NO	350	YES	6-SOT
ISL3284E	1 Rx	20	256	NO	YES	350	NO	6-SOT
ISL3285E	1 Rx	20	256	ACTIVE HIGH	YES	350	YES	8-TDFN

Pinouts

ISL3280E
(5 LD SOT-23)
TOP VIEW

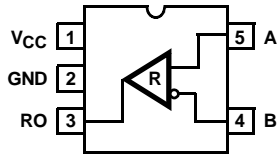

ISL3281E
(6 LD SOT-23)
TOP VIEW

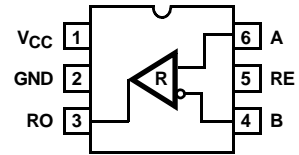

ISL3282E
(8 LD TDFN)
TOP VIEW

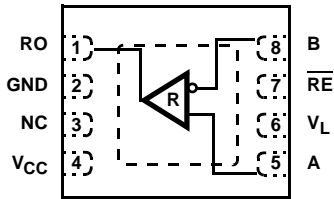

ISL3283E
(6 LD SOT-23)
TOP VIEW

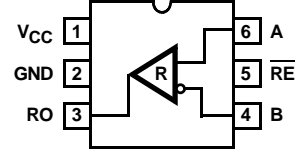

ISL3284E
(6 LD SOT-23)
TOP VIEW

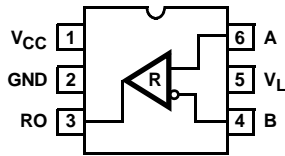

ISL3285E
(8 LD TDFN)
TOP VIEW

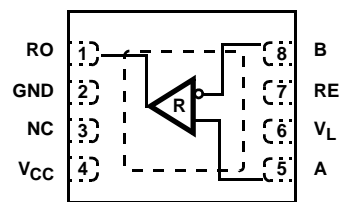

Ordering Information

PART NUMBER (Notes 1, 2)	PART MARKING (Note 3)	TEMP. RANGE (°C)	PACKAGE (Tape and Reel) (Pb-Free)	PKG. DWG. #
ISL3280EFHZ-T	280F	-40 to +125	5 Ld SOT-23	P5.064
ISL3280EIHZ-T	280I	-40 to +85	5 Ld SOT-23	P5.064
ISL3281EFHZ-T	281F	-40 to +125	6 Ld SOT-23	P6.064
ISL3281EIHZ-T	281I	-40 to +85	6 Ld SOT-23	P6.064
ISL3282EFRTZ-T	82F	-40 to +125	8 Ld TDFN	L8.2x3A
ISL3282EIRTZ-T	82I	-40 to +85	8 Ld TDFN	L8.2x3A
ISL3283EFHZ-T	283F	-40 to +125	6 Ld SOT-23	P6.064
ISL3283EIHZ-T	283I	-40 to +85	6 Ld SOT-23	P6.064
ISL3284EFHZ-T	284F	-40 to +125	6 Ld SOT-23	P6.064
ISL3284EIHZ-T	284I	-40 to +85	6 Ld SOT-23	P6.064
ISL3285EFRTZ-T	85F	-40 to +125	8 Ld TDFN	L8.2x3A
ISL3285EIRTZ-T	85I	-40 to +85	8 Ld TDFN	L8.2x3A

NOTES:

1. These Intersil Pb-free plastic packaged products employ special Pb-free material sets; molding compounds/die attach materials and 100% matte tin plate PLUS ANNEAL - e3 termination finish, which is RoHS compliant and compatible with both SnPb and Pb-free soldering operations. Intersil Pb-free products are MSL classified at Pb-free peak reflow temperatures that meet or exceed the Pb-free requirements of IPC/JEDEC J STD-020.
2. Please refer to TB347 for details on reel specifications.
3. SOT-23 "PART MARKING" is branded on the bottom side.

Truth Table

RECEIVING		
INPUTS		OUTPUT
RE, \overline{RE}	A - B	RO
1, 0	$\geq -0.05V$	1
1, 0	$\leq -0.2V$	0
1, 0	Inputs Open/Shorted	1
0, 1	X	High-Z*

NOTE: *Shutdown Mode, except for ISL3280E, ISL3284E

Pin Descriptions

PIN NAME	FUNCTION
RO	Receiver output: If A - B $\geq -50mV$, RO is high; If A - B $\leq -200mV$, RO is low; RO = High if A and B are unconnected (floating) or shorted.
RE, \overline{RE}	Receiver output enable. RO is enabled when RE/ \overline{RE} is high / low; RO is high impedance when RE/ \overline{RE} is low/high. If the Rx enable function isn't used, connect RE directly to GND, or connect RE through a 1k Ω , or greater, resistor to V _{CC} . RE/ \overline{RE} are internally pulled low/high.
GND	Ground connection. This is also the potential of the TDFN thermal pad.
A	$\pm 16.5kV$ IEC61000 ESD Protected RS-485, RS-422 level, noninverting receiver input.
B	$\pm 16.5kV$ IEC61000 ESD Protected RS-485, RS-422 level, inverting receiver input.
V _{CC}	System power supply input (3.0V to 5.5V). On devices with a V _L pin, power-up V _{CC} first.
V _L	Logic-Level Supply which sets the V _{IL} / V _{IH} levels for the \overline{RE} (ISL3282E only) and RE (ISL3285E only) pins, and sets the V _{OH} level of the RO output (ISL3282E, ISL3284E, ISL3285E only). Power-up this supply after V _{CC} , and keep V _L \leq V _{CC} .
NC	No Connection.

Typical Operating Circuits

NETWORK WITH ENABLES

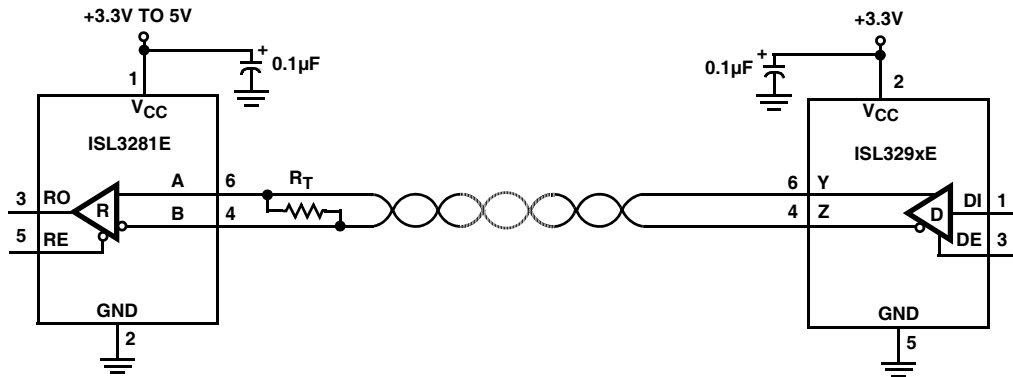

Typical Operating Circuits (Continued)

NETWORK WITHOUT ENABLES

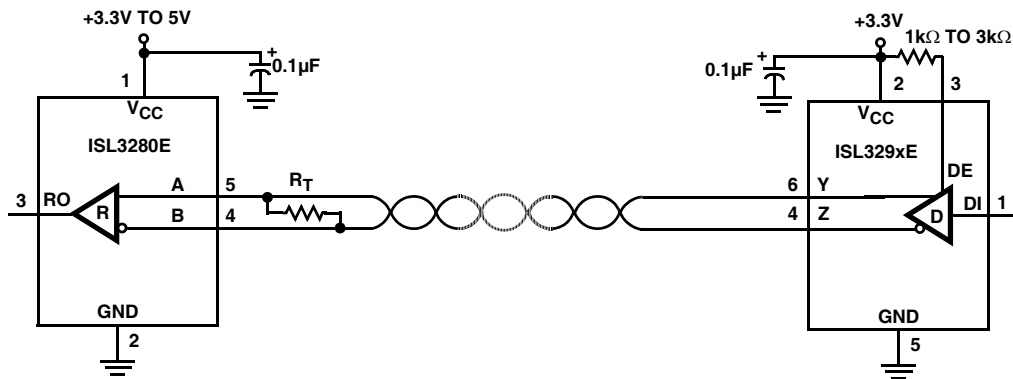

NETWORK WITH V_L PIN FOR INTERFACE TO LOWER VOLTAGE LOGIC DEVICES

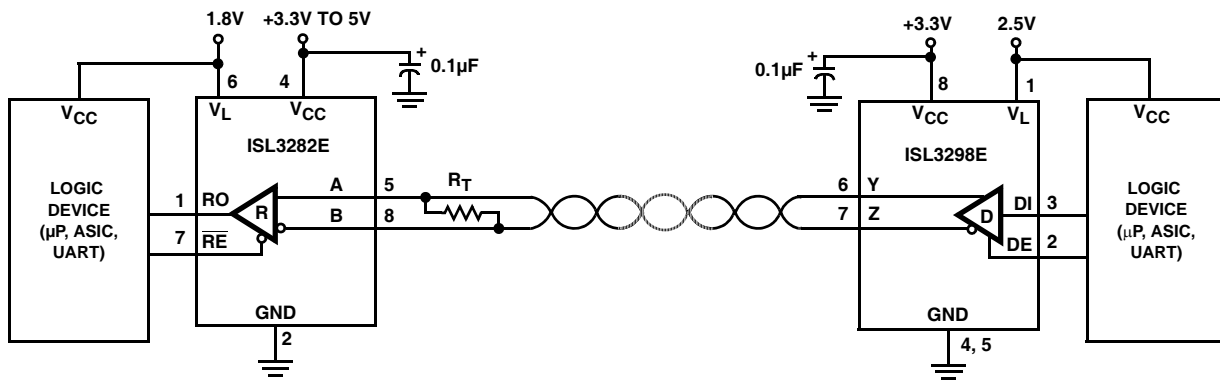

ISL3280E, ISL3281E, ISL3282E, ISL3283E, ISL3284E, ISL3285E

Absolute Maximum Ratings

V_{CC} to GND	-0.3V to 7V
V_L to GND (ISL3282E, ISL3284E, ISL3285E Only)	-0.3V to ($V_{CC} + 0.3V$)
Input Voltages RE, \overline{RE}	-0.3V to 7V
Input/Output Voltages A, B	-8V to +13V
RO (Not ISL3282E, ISL3284E, ISL3285E)	-0.3V to ($V_{CC} + 0.3V$)
RO (ISL3282E, ISL3284E, ISL3285E)	-0.3V to ($V_L + 0.3V$)
Short Circuit Duration RO	Indefinite
ESD Rating	See Specification Table

Thermal Information

Thermal Resistance (Typical)	θ_{JA} (°C/W)	θ_{JC} (°C/W)
5 Ld SOT-23 Package (Note 4)	190	N/A
6 Ld SOT-23 Package (Note 4)	177	N/A
8 Ld TDFN Package (Notes 5, 6)	65	8
Maximum Junction Temperature (Plastic Package)	+150°C	
Maximum Storage Temperature Range	-65°C to +150°C	
Pb-free reflow profile	see link below	
http://www.intersil.com/pbfree/Pb-FreeReflow.asp		

Operating Conditions

Temperature Range	
F Suffix	-40°C to +125°C
I Suffix	-40°C to +85°C

CAUTION: Do not operate at or near the maximum ratings listed for extended periods of time. Exposure to such conditions may adversely impact product reliability and result in failures not covered by warranty.

NOTE:

- θ_{JA} is measured with the component mounted on a high effective thermal conductivity test board in free air. See Tech Brief TB379 for details.
- θ_{JA} is measured in free air with the component mounted on a high effective thermal conductivity test board with "direct attach" features. See Tech Brief TB379.
- For θ_{JC} , the "case temp" location is the center of the exposed metal pad on the package underside.

Electrical Specifications Test Conditions: $V_{CC} = 3.0V$ to $5.5V$; $V_L = V_{CC}$ (ISL3282E, ISL3284E, ISL3285E only); Typicals are at $T_A = +25^\circ C$ (Note 11); Unless Otherwise Specified (Note 7).

PARAMETER	SYMBOL	TEST CONDITIONS	TEMP (°C)	MIN (Note 10)	TYP (Note 11)	MAX (Note 10)	UNITS	
DC CHARACTERISTICS								
Input High Voltage (RE, \overline{RE}) (Notes 8, 9)	V_{IH1}	$V_L = V_{CC}$ if ISL3282E, or ISL3285E	$V_{CC} \leq 3.6V$	Full	2	-	V	
	V_{IH2}		$V_{CC} \leq 5.5V$	Full	2.4	-	V	
	V_{IH3}	$2.7V \leq V_L < 3.0V$	ISL3282E and ISL3285E Only	Full	1.7	-	V	
	V_{IH4}	$2.3V \leq V_L < 2.7V$		Full	1.6	-	V	
	V_{IH5}	$1.6V \leq V_L < 2.3V$		Full	$0.72 \cdot V_L$	-	V	
	V_{IH6}	$1.35V \leq V_L < 1.6V$		25	-	$0.5 \cdot V_L$	V	
Input Low Voltage (RE, \overline{RE}) (Notes 8, 9)	V_{IL1}	$V_L = V_{CC}$ if ISL3282E or ISL3285E		Full	-	0.7	V	
	V_{IL2}	$V_L \geq 2.7V$	ISL3282E and ISL3285E Only	Full	-	0.7	V	
	V_{IL3}	$2.3V \leq V_L < 2.7V$		Full	-	0.6	V	
	V_{IL4}	$1.6V \leq V_L < 2.3V$		Full	-	$0.25 \cdot V_L$	V	
	V_{IL5}	$1.35V \leq V_L < 1.6V$		25	-	$0.33 \cdot V_L$	V	
Logic Input Current (Note 8)	I_{IN1}	RE = \overline{RE} = 0V or V_{CC}		Full	-15	± 9	μA	
Input Current (A, B)	I_{IN2}	$V_{CC} = 0V, 3.6V, \text{ or } 5.5V$	$V_{IN} = 12V$	Full	-	80	125	μA
			$V_{IN} = -7V$	Full	-100	-50	-	μA
Receiver Differential Threshold Voltage	V_{TH}	$-7V \leq V_{CM} \leq 12V$		Full	-200	-125	-50	mV
Receiver Input Hysteresis	ΔV_{TH}	$V_{CM} = 0V$		25	-	15	-	mV
Receiver Input Resistance	R_{IN}	$-7V \leq V_{CM} \leq 12V$		Full	-	150	-	k Ω
Receiver Short-Circuit Current	I_{OSR}	$0V \leq V_O \leq V_{CC}$		Full	± 7	± 30	± 85	mA
Receiver Output High Voltage	V_{OH1}	$I_O = -3.5mA, V_{ID} = -50mV$ ($V_L = V_{CC}$ if ISL3282E, ISL3284E, ISL3285E)		Full	$V_{CC} - 0.4$	-	-	V
	V_{OH2}	$I_O = -1mA, V_L \geq 1.6V$	ISL3282E, ISL3284E, and ISL3285E Only	Full	$V_L - 0.4$	-	-	V
	V_{OH3}	$I_O = -500\mu A, V_L = 1.5V$		Full	1.2	-	-	V
	V_{OH4}	$I_O = -150\mu A, V_L = 1.35V$		Full	1.15	-	-	V
	V_{OH5}	$I_O = -100\mu A, V_L \geq 1.35V$		Full	$V_L - 0.1$	-	-	V

ISL3280E, ISL3281E, ISL3282E, ISL3283E, ISL3284E, ISL3285E

Electrical Specifications Test Conditions: $V_{CC} = 3.0V$ to $5.5V$; $V_L = V_{CC}$ (ISL3282E, ISL3284E, ISL3285E only); Typical values are at $T_A = +25^\circ C$ (Note 11); Unless Otherwise Specified (Note 7). **(Continued)**

PARAMETER	SYMBOL	TEST CONDITIONS	TEMP (°C)	MIN (Note 10)	TYP (Note 11)	MAX (Note 10)	UNITS
Receiver Output Low Voltage	V_{OL1}	$I_O = 4mA$, $V_{ID} = -200mV$, $V_L \geq 2.2V$ if ISL3282E, ISL3284E, ISL3285E	Full	-	0.2	0.4	V
	V_{OL2}	$I_O = 2mA$, $V_L \geq 1.5V$	Full	-	0.2	0.4	V
	V_{OL3}	$I_O = 1mA$, $V_L \geq 1.35V$	Full	-	0.1	0.4	V
	V_{OL4}	$I_O = 500\mu A$, $V_L \geq 1.35V$	25	-	0.1	-	V
Three-State (high impedance) Receiver Output Current (Notes 8, 9)	I_{OZR}	$0V \leq V_O \leq V_{CC}$	Full	-1	0.015	1	μA
SUPPLY CURRENT							
No-Load Supply Current	I_{CC}	$RE/\overline{RE} = V_{CC}/0V$	Full	-	400	500	μA
Shutdown Supply Current (Note 8)	I_{SHDN}	$RE/\overline{RE} = 0V/V_{CC}$	Full	-	-	20	μA
ESD PERFORMANCE							
RS-485 Pins (A, B)		IEC61000-4-2, Air-Gap Discharge Method	25	-	± 16.5	-	kV
		IEC61000-4-2, Contact Discharge Method	25	-	± 9	-	kV
		Human Body Model, From Bus Pins to GND	25	-	± 16.5	-	kV
All Pins		HBM, per MIL-STD-883 Method 3015	25	-	± 5	-	kV
		MM	25	-	± 250	-	V
RECEIVER SWITCHING CHARACTERISTICS							
Maximum Data Rate	f_{MAX}	$V_{ID} = \pm 2V$, $V_{CM} = 0V$ (Figure 1 and Table 2) (Note 11)	Full	20	30, 24	-	Mbps
Receiver Input to Output Delay	t_{PLH} , t_{PHL}	$V_{ID} = \pm 2V$, $V_{CM} = 0V$ (Figure 1)	Full	20	36	60	ns
		$V_L \geq 1.5V$ (Figure 1)	25	-	44	-	ns
Receiver Skew $t_{PLH} - t_{PHL}$	t_{SK1}	$V_{CC} = 3.3V \pm 10\%$ (Figure 1)	Full	-	1	5.5	ns
	t_{SK2}	$V_{CC} = 5V \pm 10\%$ (Figure 1)	Full	-	2	7.5	ns
	t_{SK3}	$V_L \geq 1.8V$ (Figure 1)	25	-	2	-	ns
	t_{SK4}	$V_L = 1.5V$ (Figure 1)	25	-	4	-	ns
Receiver Enable to Output High (Note 8)	t_{ZH}	$R_L = 1k\Omega$, $C_L = 15pF$, $SW = GND$ (Figure 2)	Full	-	240, 90	500	ns
		$V_L \geq 1.5V$, Note 11	25	-	250, 120	-	ns
Receiver Enable to Output Low (Note 8)	t_{ZL}	$R_L = 1k\Omega$, $C_L = 15pF$, $SW = V_{CC}$ (Figure 2)	Full	-	240, 90	500	ns
		$V_L \geq 1.5V$, Note 11	25	-	250, 120	-	ns
Receiver Disable from Output High (Note 8)	t_{HZ}	$R_L = 1k\Omega$, $C_L = 15pF$, $SW = GND$ (Figure 2)	Full	-	10	20	ns
		$V_L \geq 1.5V$, Note 11	25	-	24, 20	-	ns
Receiver Disable from Output Low (Note 8)	t_{LZ}	$R_L = 1k\Omega$, $C_L = 15pF$, $SW = V_{CC}$ (Figure 2)	Full	-	10	20	ns
		$V_L \geq 1.5V$, Note 11	25	-	24, 20	-	ns

NOTES:

7. All currents into device pins are positive; all currents out of device pins are negative. All voltages are referenced to device ground unless otherwise specified.
8. Does not apply to the ISL3280E or ISL3284E.
9. If the Rx enable function isn't needed, connect the enable pin to the appropriate supply, as described in the "Pin Descriptions" table.
10. Parts are 100% tested at $+25^\circ C$. Over-temperature limits established by characterization and are not production tested.
11. Typical values are at 3.3V, 5V. Parameters with a single entry in the "TYP" column apply to 3.3V and 5V.

Test Circuits and Waveforms

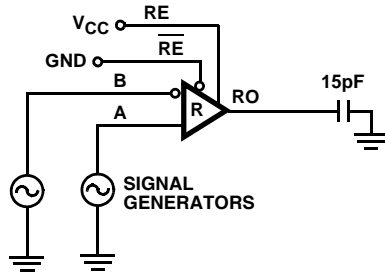

FIGURE 1A. TEST CIRCUIT

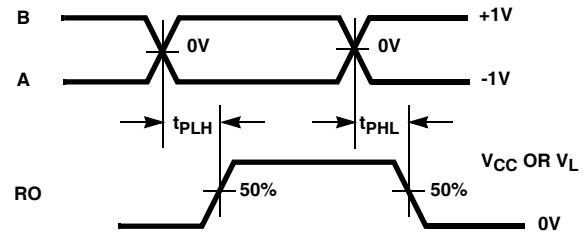
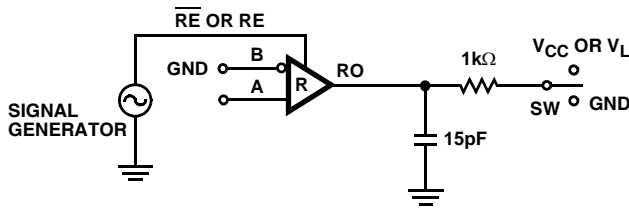

FIGURE 1B. MEASUREMENT POINTS

FIGURE 1. RECEIVER PROPAGATION DELAY AND DATA RATE



PARAMETER	A	SW
t_{HZ}	+1.5V	GND
t_{LZ}	-1.5V	V_{CC} OR V_L
t_{ZH}	+1.5V	GND
t_{ZL}	-1.5V	V_{CC} OR V_L

FIGURE 2A. TEST CIRCUIT

FIGURE 2. RECEIVER ENABLE AND DISABLE TIMES (EXCEPT ISL3280E AND ISL3284E)

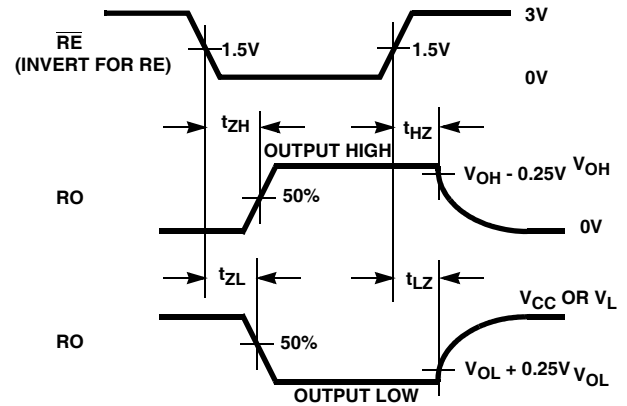

FIGURE 2B. MEASUREMENT POINTS

Application Information

RS-485 and RS-422 are differential (balanced) data transmission standards for use in long haul or noisy environments. RS-422 is a subset of RS-485, so RS-485 transceivers are also RS-422 compliant. RS-422 is a point-to-multipoint (multidrop) standard, which allows only one driver and up to 10 (assuming one unit load devices) receivers on each bus. RS-485 is a true multipoint standard, which allows up to 32 one unit load devices (any combination of drivers and receivers) on each bus.

Another important advantage of RS-485 is the extended common mode range (CMR), which specifies that the driver outputs and receiver inputs withstand signals that range from +12V to -7V. RS-422 and RS-485 are intended for runs as long as 4000', so the wide CMR is necessary to handle ground potential differences, as well as voltages induced in the cable by external fields.

Receiver Features

These devices utilize a differential input receiver for maximum noise immunity and common mode rejection. Input sensitivity is better than $\pm 200\text{mV}$, as required by the RS-422 and RS-485 specifications.

Receiver input resistance of $96\text{k}\Omega$ surpasses the RS-422 specification of $4\text{k}\Omega$ and is eight times the RS-485 "Unit Load (UL)" requirement of $12\text{k}\Omega$ minimum. Thus, these products are known as "one-eighth UL" transceivers and there can be up to 256 of these devices on a network while still complying with the RS-485 loading specification.

Receiver inputs function with common mode voltages as great as +9V/-7V outside the power supplies (i.e., +12V and -7V), making them ideal for long networks where induced voltages, and ground potential differences are realistic concerns.

All the receivers include a “full fail-safe” function that guarantees a high level receiver output if the receiver inputs are unconnected (floating), shorted together, or connected to a terminated but undriven bus. Fail-safe with shorted inputs is achieved by setting the Rx upper switching point to -50mV, thereby ensuring that the Rx sees 0V differential as a high input level.

All receivers easily support a 20Mbps data rate, and all receiver outputs (except on the ISL3280E and ISL3284E) are tri-statable via the active low \overline{RE} input or by the active high RE input.

TABLE 2. V_{IH} , V_{IL} AND DATA RATE vs V_L FOR $V_{CC} = 3.3V$ OR $5V$

V_L (V)	V_{IH} (V)	V_{IL} (V)	DATA RATE (Mbps)
1.35	0.55	0.5	11
1.6	0.7	0.6	16
1.8	0.8	0.7	23
2.3	1	0.9	27
2.7	1.1	1	30
3.3	1.3	1.2	30
5.5 (i.e., V_{CC})	2	1.8	24

Wide Supply Range

The ISL3280E, ISL3281E, ISL3282E, ISL3283E, ISL3284E, ISL3285E are designed to operate with a wide range of supply voltages from 3.0V to 5.5V. These devices meet the RS-422 and RS-485 specifications over this full range.

Logic Supply (V_L Pin, ISL3282E, ISL3284E, ISL3285E Only)

Note: Power-up V_{CC} before powering up the V_L supply.

The ISL3282E, ISL3284E, and ISL3285E include a V_L pin that powers the logic input (\overline{RE} or RE) and / or the Rx output. These pins interface with “logic” devices such as UARTs, ASICs, and microcontrollers and today most of these devices use power supplies significantly lower than 3.3V. Thus, a 3.3V output level from a 3.3V powered RS-485 IC might seriously overdrive and damage the logic device input. Similarly, the logic device’s low V_{OH} might not exceed the V_{IH} of a 3.3V or 5V powered \overline{RE} input. Connecting the V_L pin to the power supply of the logic device (as shown in Figure 3) limits the ISL3282E, ISL3284E, ISL3285E’s Rx output V_{OH} to V_L (see Figures 6 through 10), and reduces the \overline{RE} / RE input switching point to a value compatible with the logic device’s output levels. Tailoring the logic pin input switching point and output levels to the supply voltage of the UART, ASIC, or microcontroller eliminates the need for a level shifter/translator between the two ICs.

V_L can be anywhere from V_{CC} down to 1.35V, but the input switching points may not provide enough noise margin when $V_L < 1.6V$. Table 2 indicates typical V_{IH} , V_{IL} , and data rate values for various V_L settings so the user can ascertain whether or not a particular V_L voltage meets his/her needs.

The quiescent, RO unloaded, V_L supply current (I_L) is typically less than 60µA for $V_L \leq 3.3V$, as shown in Figure 5.

ESD Protection

All pins on these devices include class 3 (>4kV) Human Body Model (HBM) ESD protection structures, but the RS-485 pins (receiver inputs) incorporate advanced structures allowing them to survive ESD events in excess of ±16.5kV HBM and ±16.5kV IEC61000. The RS-485 pins are particularly vulnerable to ESD damage because they typically connect to an exposed port on the exterior of the finished product. Simply touching the port pins, or connecting a cable, can cause an ESD event that might destroy unprotected ICs. These new ESD structures protect the device whether or not it is powered up, and without degrading the RS-485 common mode range of -7V to +12V. This built-in ESD protection eliminates the need for board level protection structures (e.g., transient suppression diodes), and the associated, undesirable capacitive load they present.

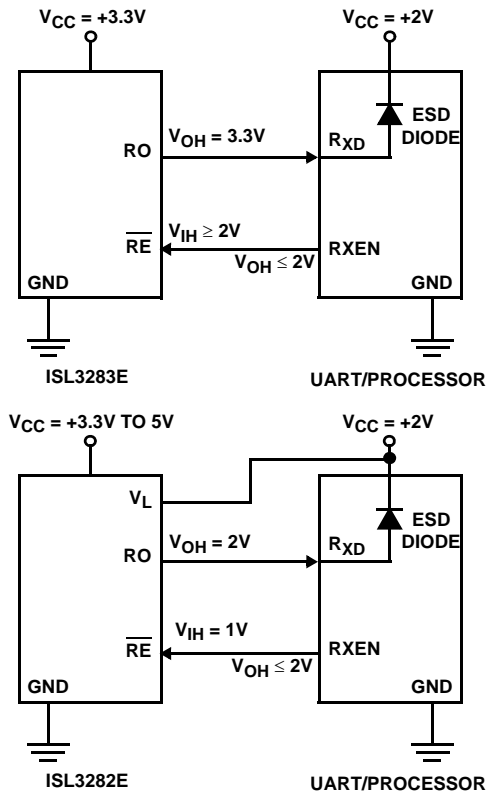

FIGURE 3. USING V_L PIN TO ADJUST LOGIC LEVELS

IEC61000-4-2 Testing

The IEC61000 test method applies to finished equipment, rather than to an individual IC. Therefore, the pins most likely to suffer an ESD event are those that are exposed to the outside world (the RS-485 pins in this case), and the IC is tested in its typical application configuration (power applied) rather than testing each pin-to-pin combination. The lower current limiting resistor coupled with the larger charge storage capacitor yields a test that is much more severe than the HBM test. The extra ESD protection built into this device's RS-485 pins allows the design of equipment meeting level 4 criteria without the need for additional board level protection on the RS-485 port.

AIR-GAP DISCHARGE TEST METHOD

For this test method, a charged probe tip moves toward the IC pin until the voltage arcs to it. The current waveform delivered to the IC pin depends on approach speed, humidity, temperature, etc., so it is difficult to obtain repeatable results. The A and B RS-485 pins withstand ±16.5kV air-gap discharges.

CONTACT DISCHARGE TEST METHOD

During the contact discharge test, the probe contacts the tested pin before the probe tip is energized, thereby eliminating the variables associated with the air-gap discharge. The result is a more repeatable and predictable test, but equipment limits prevent testing devices at voltages higher than ±9kV. The ISL3280E, ISL3281E, ISL3282E, ISL3283E, ISL3284E, ISL3285E survive ±9kV contact discharges on the RS-485 pins.

Data Rate, Cables, and Terminations

RS-485, RS-422 are intended for network lengths up to 4000', but the maximum system data rate decreases as the

transmission length increases. Networks operating at 20Mbps are limited to lengths less than 100', while a 250kbps network that uses slew rate limited transmitters can operate at that data rate over lengths of several thousand feet.

Twisted pair is the cable of choice for RS-485, RS-422 networks. Twisted pair cables tend to pick up noise and other electromagnetically induced voltages as common mode signals, which are effectively rejected by the differential receiver in these ICs.

To minimize reflections, proper termination is imperative for high data rate networks. Short networks using slew rate limited transmitters need not be terminated, but terminations are recommended unless power dissipation is an overriding concern.

In point-to-point, or point-to-multipoint (single driver on bus) networks, the main cable should be terminated in its characteristic impedance (typically 120Ω) at the end farthest from the driver. In multi-receiver applications, stubs connecting receivers to the main cable should be kept as short as possible. Multipoint (multi-driver) systems require that the main cable be terminated in its characteristic impedance at both ends. Stubs connecting a transmitter or receiver to the main cable should be kept as short as possible.

Low Power Shutdown Mode

These BiCMOS receivers all use a fraction of the power required by their bipolar counterparts, and the versions with output enable functions include a shutdown feature that reduces the already low quiescent I_{CC} to a 20μA trickle. These versions enter shutdown whenever the receiver disables ($\overline{RE} = V_{CC}$ or $RE = GND$).

Typical Performance Curves C_L = 15pF, T_A = +25°C; Unless Otherwise Specified.

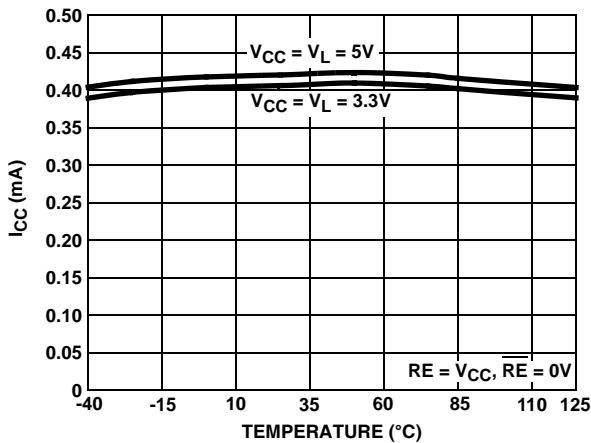

FIGURE 4. SUPPLY CURRENT vs TEMPERATURE

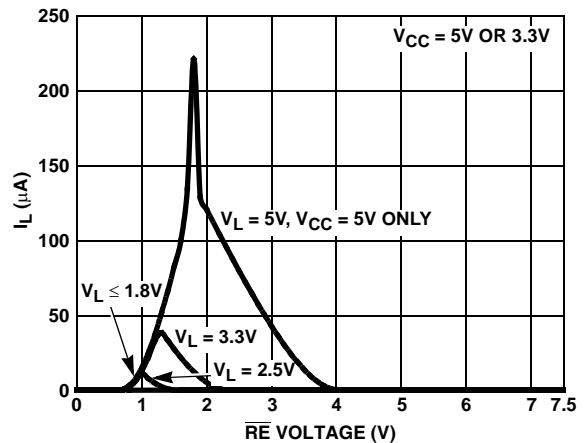

FIGURE 5. V_L SUPPLY CURRENT vs ENABLE PIN VOLTAGE

Typical Performance Curves $C_L = 15\text{pF}$, $T_A = +25^\circ\text{C}$; Unless Otherwise Specified. (Continued)

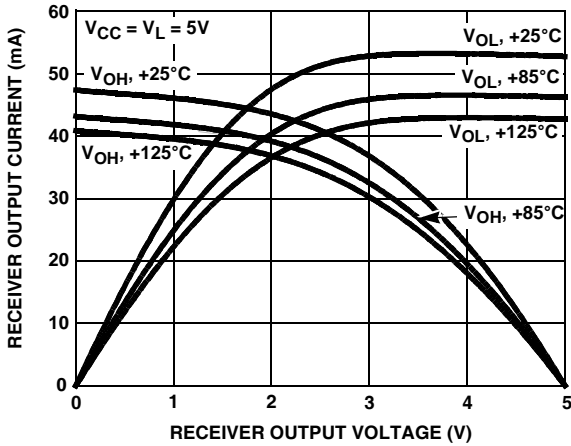

FIGURE 6. RECEIVER OUTPUT CURRENT vs RECEIVER OUTPUT VOLTAGE

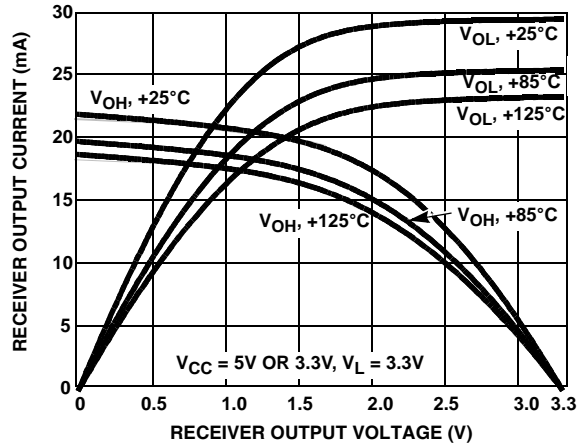

FIGURE 7. RECEIVER OUTPUT CURRENT vs RECEIVER OUTPUT VOLTAGE

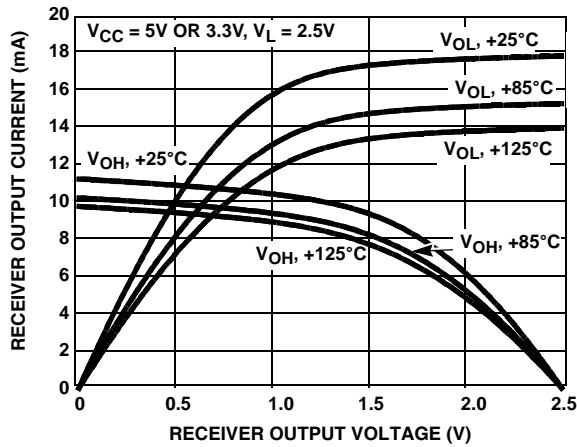

FIGURE 8. RECEIVER OUTPUT CURRENT vs RECEIVER OUTPUT VOLTAGE

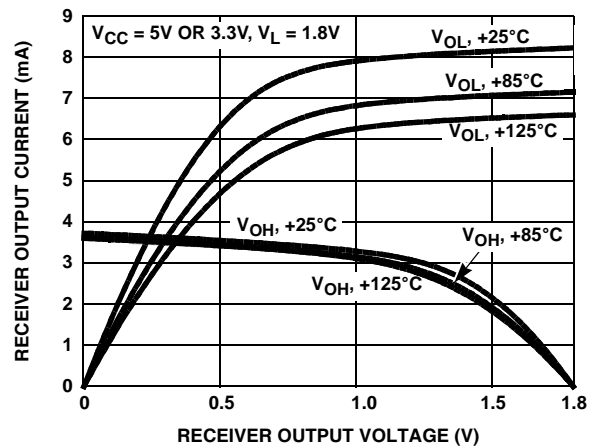

FIGURE 9. RECEIVER OUTPUT CURRENT vs RECEIVER OUTPUT VOLTAGE

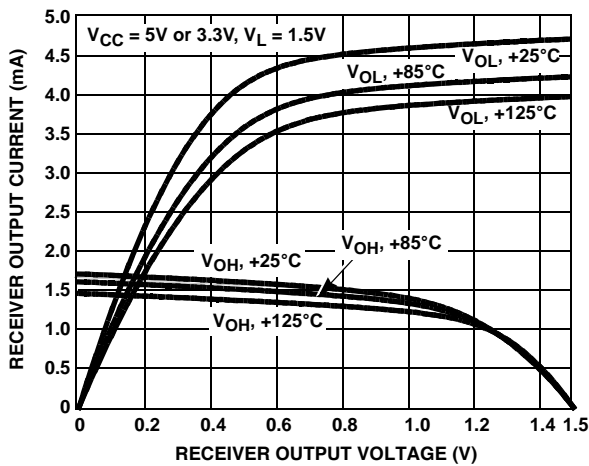

FIGURE 10. RECEIVER OUTPUT CURRENT vs RECEIVER OUTPUT VOLTAGE

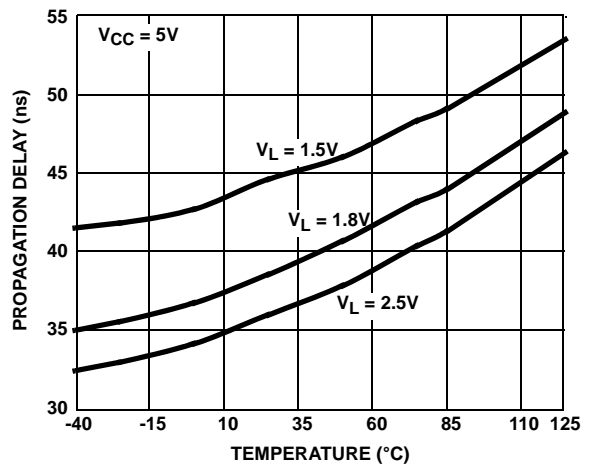

FIGURE 11. RECEIVER PROPAGATION DELAY vs TEMPERATURE

Typical Performance Curves $C_L = 15\text{pF}$, $T_A = +25^\circ\text{C}$; Unless Otherwise Specified. (Continued)

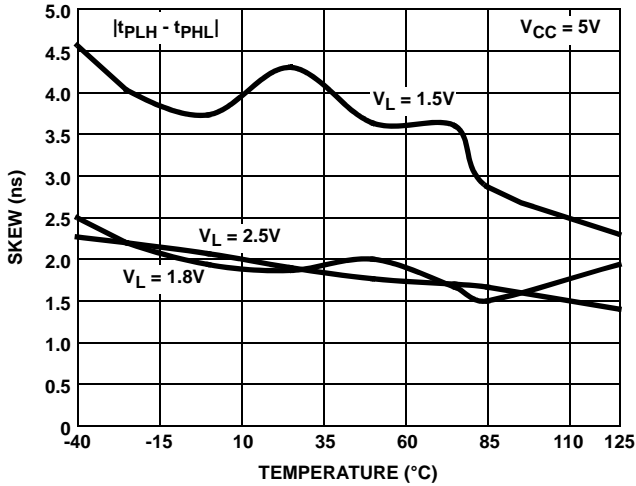

FIGURE 12. RECEIVER SKEW vs TEMPERATURE

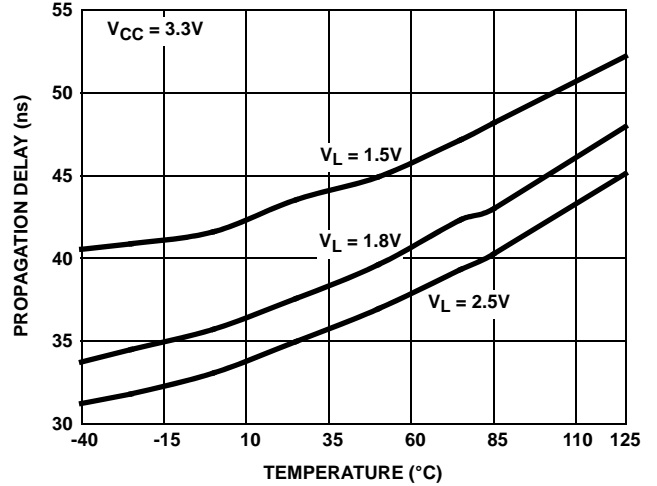

FIGURE 13. RECEIVER PROPAGATION DELAY vs TEMPERATURE

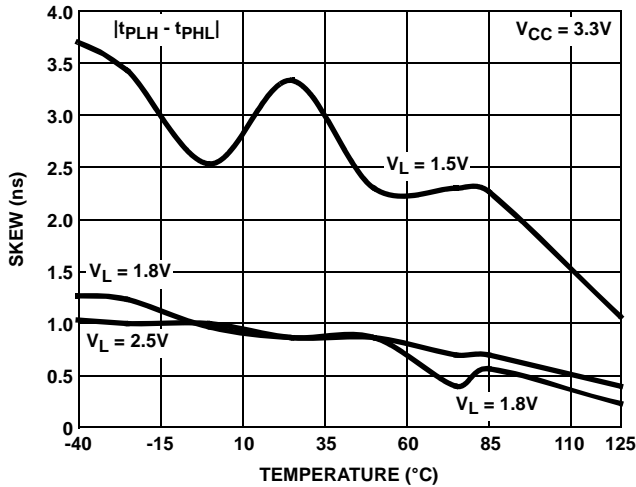

FIGURE 14. RECEIVER SKEW vs TEMPERATURE

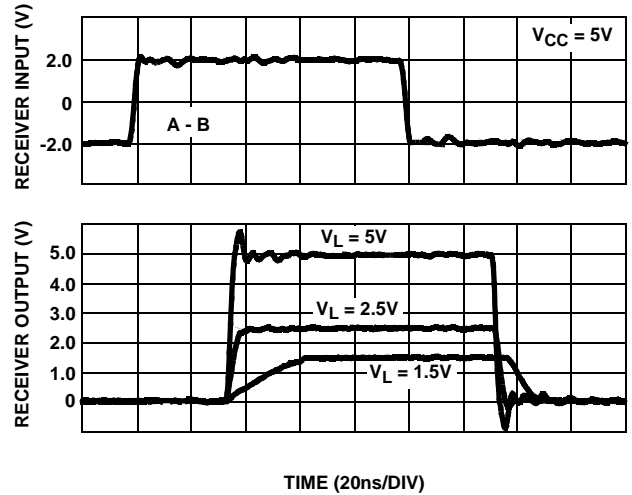

FIGURE 15. RECEIVER WAVEFORMS

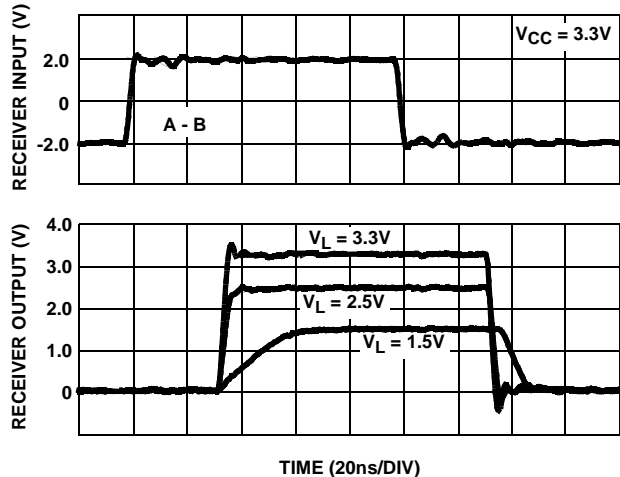

FIGURE 16. RECEIVER WAVEFORMS

Die Characteristics

SUBSTRATE AND TDFN THERMAL PAD POTENTIAL (POWERED UP):

GND

TRANSISTOR COUNT:

140

PROCESS:

Si Gate BiCMOS

Small Outline Transistor Plastic Packages (SOT23-5)

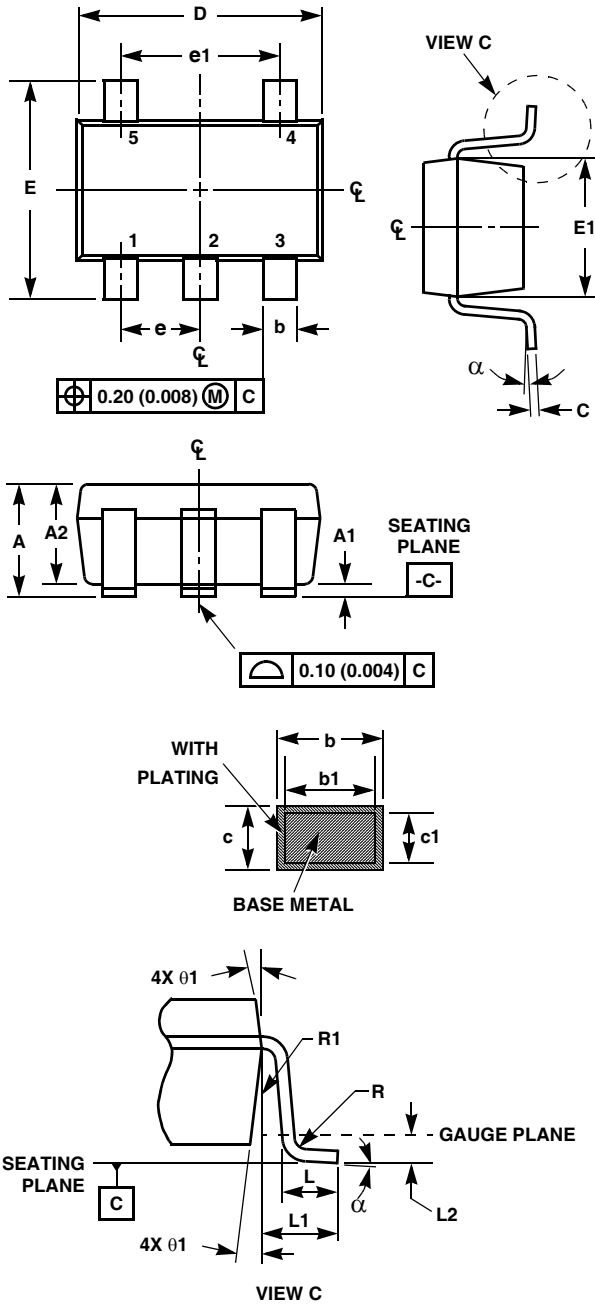

P5.064

5 LEAD SMALL OUTLINE TRANSISTOR PLASTIC PACKAGE

SYMBOL	INCHES		MILLIMETERS		NOTES
	MIN	MAX	MIN	MAX	
A	0.036	0.057	0.90	1.45	-
A1	0.000	0.0059	0.00	0.15	-
A2	0.036	0.051	0.90	1.30	-
b	0.012	0.020	0.30	0.50	-
b1	0.012	0.018	0.30	0.45	-
c	0.003	0.009	0.08	0.22	6
c1	0.003	0.008	0.08	0.20	6
D	0.111	0.118	2.80	3.00	3
E	0.103	0.118	2.60	3.00	-
E1	0.060	0.067	1.50	1.70	3
e	0.0374 Ref		0.95 Ref		-
e1	0.0748 Ref		1.90 Ref		-
L	0.014	0.022	0.35	0.55	4
L1	0.024 Ref.		0.60 Ref.		-
L2	0.010 Ref.		0.25 Ref.		-
N	5		5		5
R	0.004	-	0.10	-	-
R1	0.004	0.010	0.10	0.25	-
α	0°	8°	0°	8°	-

Rev. 2 9/03

NOTES:

1. Dimensioning and tolerance per ASME Y14.5M-1994.
2. Package conforms to EIAJ SC-74 and JEDEC MO178AA.
3. Dimensions D and E1 are exclusive of mold flash, protrusions, or gate burrs.
4. Footlength L measured at reference to gauge plane.
5. "N" is the number of terminal positions.
6. These Dimensions apply to the flat section of the lead between 0.08mm and 0.15mm from the lead tip.
7. Controlling dimension: MILLIMETER. Converted inch dimensions are for reference only.

Small Outline Transistor Plastic Packages (SOT23-6)

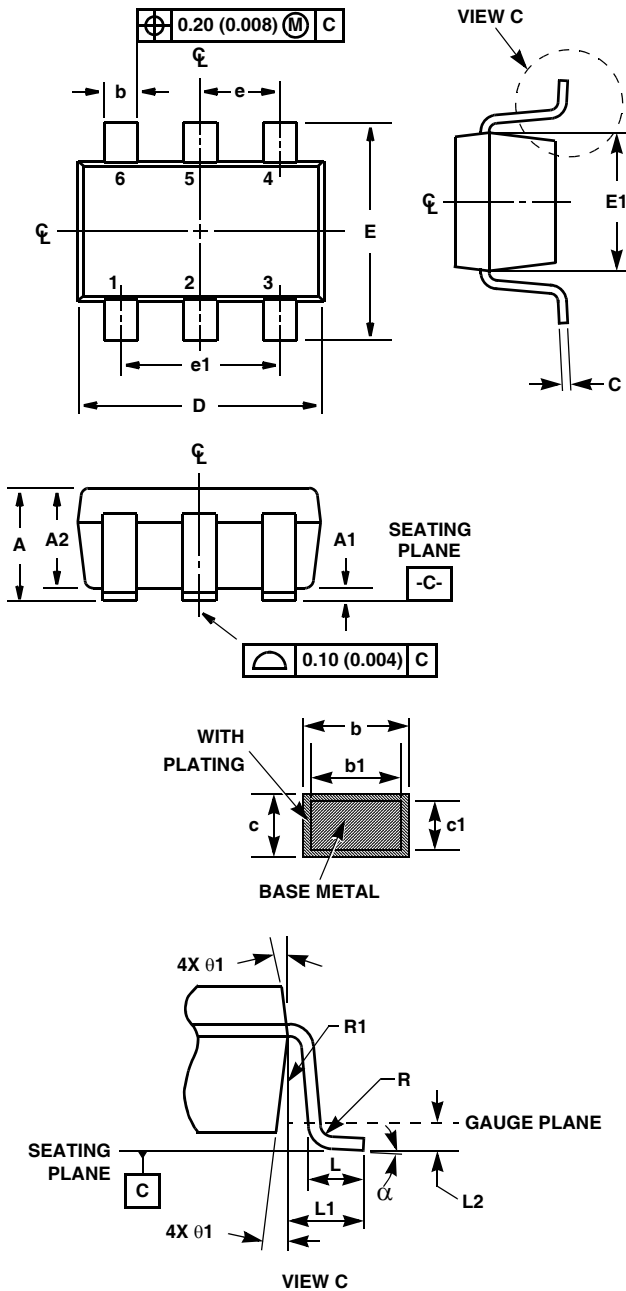

P6.064

6 LEAD SMALL OUTLINE TRANSISTOR PLASTIC PACKAGE

SYMBOL	INCHES		MILLIMETERS		NOTES
	MIN	MAX	MIN	MAX	
A	0.036	0.057	0.90	1.45	-
A1	0.000	0.0059	0.00	0.15	-
A2	0.036	0.051	0.90	1.30	-
b	0.012	0.020	0.30	0.50	-
b1	0.012	0.018	0.30	0.45	-
c	0.003	0.009	0.08	0.22	6
c1	0.003	0.008	0.08	0.20	6
D	0.111	0.118	2.80	3.00	3
E	0.103	0.118	2.60	3.00	-
E1	0.060	0.068	1.50	1.75	3
e	0.0374 Ref		0.95 Ref		-
e1	0.0748 Ref		1.90 Ref		-
L	0.014	0.022	0.35	0.55	4
L1	0.024 Ref.		0.60 Ref.		-
L2	0.010 Ref.		0.25 Ref.		-
N	6		6		5
R	0.004	-	0.10	-	-
R1	0.004	0.010	0.10	0.25	-
α	0°	8°	0°	8°	-

Rev. 3 9/03

NOTES:

1. Dimensioning and tolerance per ASME Y14.5M-1994.
2. Package conforms to EIAJ SC-74 and JEDEC MO178AB.
3. Dimensions D and E1 are exclusive of mold flash, protrusions, or gate burrs.
4. Footlength L measured at reference to gauge plane.
5. "N" is the number of terminal positions.
6. These Dimensions apply to the flat section of the lead between 0.08mm and 0.15mm from the lead tip.
7. Controlling dimension: MILLIMETER. Converted inch dimensions are for reference only

Thin Dual Flat No-Lead Plastic Package (TDFN)

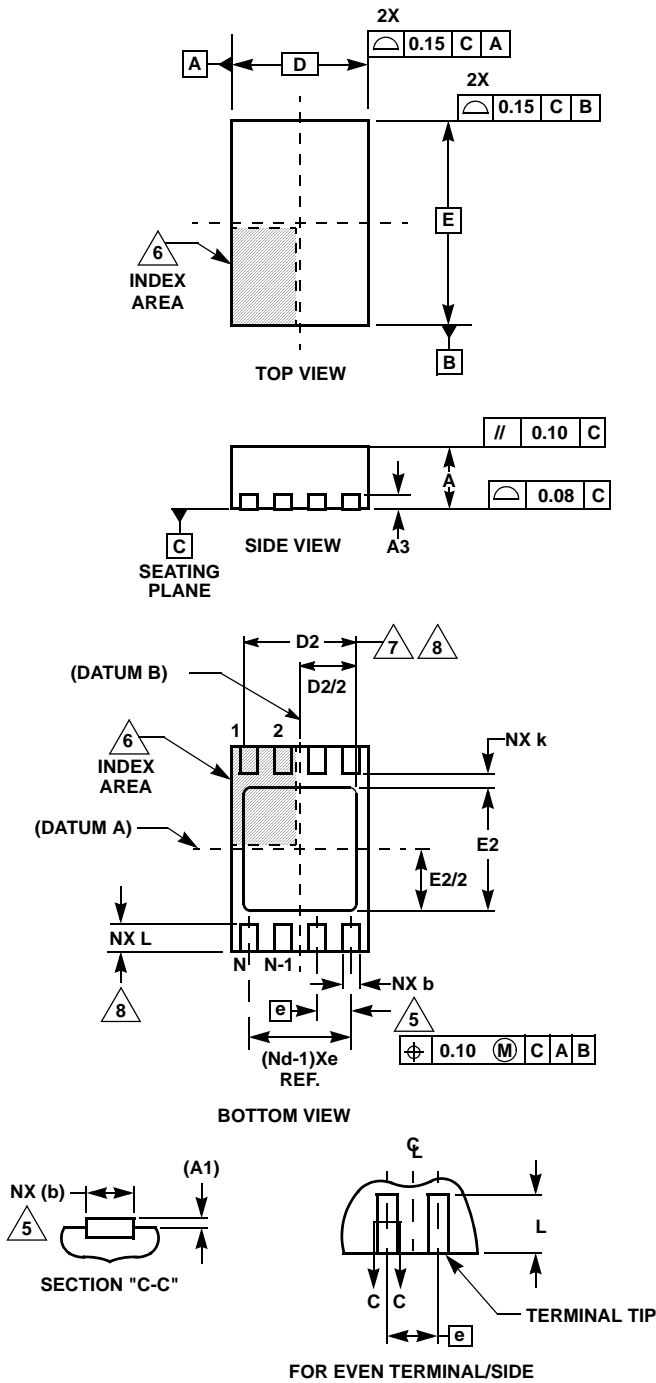

L8.2x3A

8 LEAD THIN DUAL FLAT NO-LEAD PLASTIC PACKAGE

SYMBOL	MILLIMETERS			NOTES
	MIN	NOMINAL	MAX	
A	0.70	0.75	0.80	-
A1	-	-	0.05	-
A3	0.20 REF			-
b	0.20	0.25	0.32	5,8
D	2.00 BSC			-
D2	1.50	1.65	1.75	7,8
E	3.00 BSC			-
E2	1.65	1.80	1.90	7,8
e	0.50 BSC			-
k	0.20	-	-	-
L	0.30	0.40	0.50	8
N	8			2
Nd	4			3

Rev. 0 6/04

NOTES:

1. Dimensioning and tolerancing conform to ASME Y14.5-1994.
2. N is the number of terminals.
3. Nd refers to the number of terminals on D.
4. All dimensions are in millimeters. Angles are in degrees.
5. Dimension b applies to the metallized terminal and is measured between 0.25mm and 0.30mm from the terminal tip.
6. The configuration of the pin #1 identifier is optional, but must be located within the zone indicated. The pin #1 identifier may be either a mold or mark feature.
7. Dimensions D2 and E2 are for the exposed pads which provide improved electrical and thermal performance.
8. Nominal dimensions are provided to assist with PCB Land Pattern Design efforts, see Intersil Technical Brief TB389.

All Intersil U.S. products are manufactured, assembled and tested utilizing ISO9000 quality systems. Intersil Corporation's quality certifications can be viewed at www.intersil.com/design/quality

Intersil products are sold by description only. Intersil Corporation reserves the right to make changes in circuit design, software and/or specifications at any time without notice. Accordingly, the reader is cautioned to verify that data sheets are current before placing orders. Information furnished by Intersil is believed to be accurate and reliable. However, no responsibility is assumed by Intersil or its subsidiaries for its use; nor for any infringements of patents or other rights of third parties which may result from its use. No license is granted by implication or otherwise under any patent or patent rights of Intersil or its subsidiaries.

For information regarding Intersil Corporation and its products, see www.intersil.com