

MAX20335

PMIC with Ultra-Low I_Q Voltage Regulators and Battery Chargers for Small Lithium Ion Systems

General Description

The MAX20335 is a battery-charge-management solution ideal for low-power wearable applications. The device includes a linear battery charger with a smart power selector and several power-optimized peripherals. The MAX20335 features two ultra-low quiescent current buck regulators and three ultra-low quiescent current low-dropout (LDO) linear regulators, providing up to five regulated voltages, each with an ultra-low quiescent current, allows designers to minimize power consumption and extend battery life in 24/7 operation devices, such as those in the wearable market.

The battery charger features a smart power selector that allows operation on a dead battery when connected to a power source. To avoid overloading a power adapter, the input current to the smart power selector is limited based on an I²C register setting. If the charger power source is unable to supply the entire system load, the smart power control circuit supplements the system load with current from the battery. The charger also supports temperature dependent charge currents.

The two synchronous, high-efficiency step-down buck regulators feature a variable frequency mode for increased efficiency during light-load operation. The output voltage of these regulators can be programmed through I²C with the default preconfigured. The buck regulators can support dynamic voltage scaling to further improve system power consumption.

The three configurable LDOs each have a dedicated input pin. Each LDO regulator output voltage can be programmed through I²C with the default preconfigured. The linear regulators can also be configured to operate as power switches that may be used to disconnect the quiescent load of the system peripherals.

The MAX20335 features a programmable power controller that allows the device to be configured for applications that require the device be in a true-off, or always-on, state. The controller also provides a delayed reset signal and voltage sequencing.

The MAX20335 is available in a 36-bump, 0.4mm pitch, 2.72mm x 2.47mm wafer-level package (WLP).

Benefits and Features

- Extend System Use Time Between Battery Charging
 - Dual Ultra-Low-I_Q 200mA Buck Regulators
 - Output Programmable from 0.7V to 2.275V and 0.7V to 3.85V
 - 0.9μA (typ) Quiescent Current (Buck 1)
 - Optional Fixed Peak-Current Mode to Optimize Ripple Frequency in Noise-Sensitive Applications
 - Three Ultra-Low-I_Q 100mA LDOs
 - LDO1
 - Output Programmable from 0.8V to 3.6V
 - 0.6μA (typ) Quiescent Current
 - 2.7V to 5.5V Input with Dedicated Pin
 - LDO2/3
 - Output Programmable from 0.9V to 4V
 - 1μA (typ) Quiescent Current
 - 1.71V to 5.5V Input with Dedicated Pin
- Easy-to-Implement Li+ Battery Charging
 - Smart Power Selector
 - 28V/-5.5V Tolerant Input
 - Thermistor Monitor
- Minimize Solution Footprint Through High Integration
 - Provides Five Regulated Voltage Rails
 - Switch Mode Option on Each LDO
- Optimize System Control
 - Monitors Pushbutton for Ultra-Low Power Mode
 - Power-On Reset Delay and Voltage Sequencing
 - On-Chip Voltage Monitor Multiplexer

Applications

- Wearable Electronics
- Fitness Monitors
- Rechargeable IoT devices

[Ordering Information](#) appears at end of data sheet.

TABLE OF CONTENTS

General Description	1
Benefits and Features	1
Applications	1
Typical Application Circuit	5
Absolute Maximum Ratings	6
Package Information	6
Electrical Characteristics	7
Typical Operating Characteristics	22
Bump Configuration	25
Bump Description	25
Block Diagram	27
Detailed Description	27
Power Regulation	27
Power On/Off and Reset Control	27
Power Sequencing	30
Smart Power Selector	31
Thermal Current Regulation	31
System Load Switch	32
Input Limiter	32
Fast-Charge Current Setting	33
Thermistor Monitoring with Charger Shutdown	33
I ² C Interface	35
I ² C Addresses	35
Thermistor Monitoring with Charger Shutdown	36
I ² C Interface	38
Start, Stop, And Repeated Start Conditions	38
Slave Address	38
Bit Transfer	38
Single-Byte Write	38
Burst Write	39
Single Byte Read	39
Burst Read	40
Acknowledge Bits	40
I ² C Register Map	41
I ² C Register Descriptions	43

TABLE OF CONTENTS (continued)

Applications Information	63
Inductor Selection	63
Output Capacitor Selection	63
Input Capacitor Selection	63
PCB Layout and Routing	63
Ordering Information	66
Chip Information	66
Revision History	67

LIST OF FIGURES

Figure 1. Power Function Input Control Modes Flow Diagrams	29
Figure 2a. Power-On Sequencing	30
Figure 2b. Power-On Sequencing Without Battery	31
Figure 3. Smart Power Selector Current/Voltage Behavior	32
Figure 4a. Charging Behavior Using Thermistor Monitoring Mode	34
Figure 4b. Charging Behavior Using JEITA Monitoring 1 and 2 Modes	34
Figure 5a. Charger State Diagram (Thermistor Monitoring with Charger Shutdown)	36
Figure 5b. Battery Charger State Diagram (JEITA Monitoring with Charger Shutdown)	37
Figure 6. I ² C START, STOP and REPEATED START Conditions	38
Figure 7. Write Byte Sequence	38
Figure 8. Burst Write Sequence	39
Figure 9. Read Byte Sequence	39
Figure 10. Burst Read Sequence	40
Figure 11. Acknowledge	40

LIST OF TABLES

Table 1. Power Function Input Control Modes	28
Table 2. Thermistor Monitoring/JEITA Monitoring Enable Control	35
Table 3. I ² C Slave Addresses	38
Table 4. ChipId Register (0x00)	43
Table 5. ChipRev Register (0x01)	43
Table 6. StatusA Register (0x02)	43
Table 7. StatusB Register (0x03)	44

LIST OF TABLES (continued)

Table 8. StatusC Register (0x04)	45
Table 9. IntA Register (0x05)	46
Table 10. IntB Register (0x06)	46
Table 11. IntMaskA Register (0x07)	47
Table 12. IntMaskB Register (0x08)	48
Table 13. ILimCntl Register (0x09)	48
Table 14. ChgCntlA Register (0x0A)	49
Table 15. ChgCntlB Register (0x0B)	50
Table 16. ChTmr Register (0x0C)	51
Table 17. Buck1Cfg Register (0x0D)	52
Table 18. Buck1VSet Register (0x0E)	53
Table 19. Buck2Cfg Register (0x0F)	53
Table 20. Buck2VSet Register (0x10)	54
Table 21. Buck1/2ISet Register (0x11)	54
Table 22. LDO1Cfg Register (0x12)	55
Table 23. LDO1VSet Register (0x13)	55
Table 24. LDO2Cfg Register (0x14)	56
Table 25. LDO2VSet Register (0x15)	56
Table 26. LDO3Cfg Register (0x16)	57
Table 27. LDO3VSet Register (0x17)	57
Table 28. ThrmCfg Register (0x18)	58
Table 29. ThrmCfg Register (0x19)	59
Table 30. MONCfg Register (0x1A)	59
Table 31. BootCfg Register (0x1B)	60
Table 32. PinStat Register (0x1C)	60
Table 33. Buck1/2Extra Control Register (0x1D)	61
Table 34. PwrCfg Register (0x1E)	62
Table 35. PwrCmd Register (0x1F)	62
Table 36. Suggested Inductors	63
Table 37. Output Capacitor Values*	63
Table 38. Register Bit Default Values	64
Table 39. Register Default Values	65

Typical Application Circuit

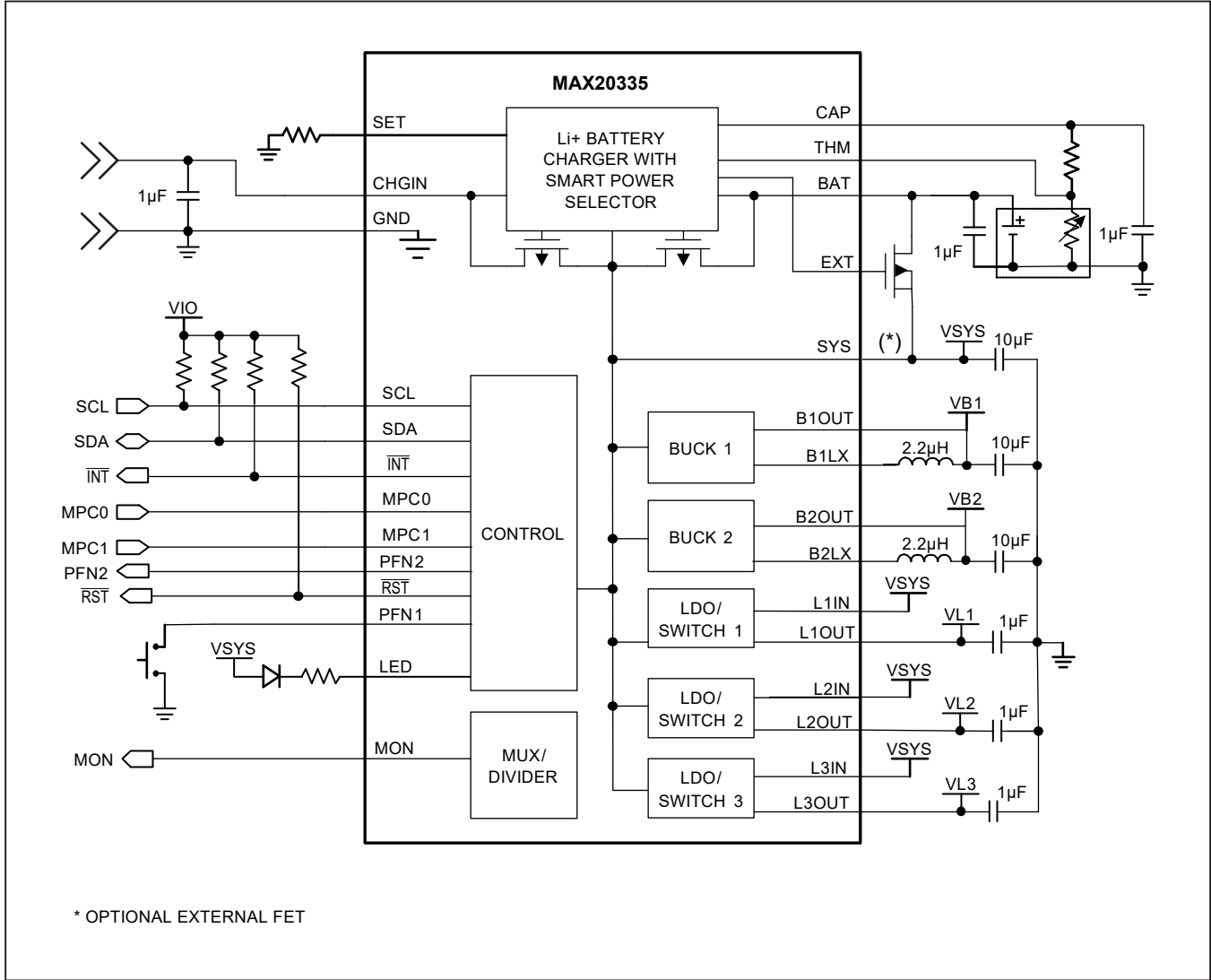

Absolute Maximum Ratings

(Voltages referenced to GND.)

SDA, SCL, THM, RST, SYS, PFN1, PFN2, MPC0, MPC1, INT, MON, BAT, LED, L1IN, L2IN, L3IN.....	-0.3V to +6.0V
B1LX, B2LX, B1OUT, B2OUT, EXT	-0.3V to (V _{SYS} + 0.3V)
L1OUT	-0.3V to (V _{L1IN} + 0.3V)
L2OUT	-0.3V to (V _{L2IN} + 0.3V)
L3OUT	-0.3V to (V _{L3IN} + 0.3V)
CHGIN	-6V to +30V
CAP	-0.3V to min (V _{CHGIN} + 0.3V, +6V)
SET	-0.3V to V _{BAT} + 0.3V

Continuous Current into CHGIN, BAT, SYS	±1000mA
Continuous Current into any other terminal	±100mA
Continuous Power Dissipation (multilayer board at +70°C):	
6 x 6 Array 36-Bump 2.72mm x 2.47mm	
0.4mm Pitch WLP (derate 21.70mW/°C).....	1.74W
Operating Temperature Range.....	-40°C to +85°C
Junction Temperature.....	+150°C
Storage Temperature Range	-65°C to +150°C
Soldering Temperature (reflow)	+260°C

Stresses beyond those listed under "Absolute Maximum Ratings" may cause permanent damage to the device. These are stress ratings only; functional operation of the device at these or any other conditions beyond those indicated in the operational sections of the specifications is not implied. Exposure to absolute maximum rating conditions for extended periods may affect device reliability.

Package Information

PACKAGE TYPE: 36 WLP	
Package Code	W362D2+1
Outline Number	21-0897
Land Pattern Number	Refer to Application Note 1891
THERMAL RESISTANCE, FOUR-LAYER BOARD	
Junction to Ambient (θ _{JA})	46°C/W

For the latest package outline information and land patterns (footprints), go to www.maximintegrated.com/packages. Note that a "+", "#", or "-" in the package code indicates RoHS status only. Package drawings may show a different suffix character, but the drawing pertains to the package regardless of RoHS status.

Package thermal resistances were obtained using the method described in JEDEC specification JESD51-7, using a four-layer board. For detailed information on package thermal considerations, refer to www.maximintegrated.com/thermal-tutorial.

Electrical Characteristics

(V_{CHGIN} = 5.0V, V_{BAT} = 3.7V, T_A = -40°C to +85°C, all registers in their default state, unless otherwise noted. Typical values are at T_A = +25°C.) (Note 1)

PARAMETER	SYMBOL	CONDITIONS	MIN	TYP	MAX	UNITS
GLOBAL SUPPLY CURRENT (L_IN Connected to SYS)						
Charger Input Current	I _{CHG}	All functions disabled		0.26		mA
		Power on, V _{CHGIN} = 5V SYS switch closed, buck regulators enabled, LDO1 enabled, I _{SYS} = 0A, I _{B_OUT} = 0A, I _{L_OUT} = 0A			1.5	
BAT Input Current	I _{BAT}	Power off, V _{CHGIN} = 0V, SYS switch open		0.96	1.7	μA
		Power on, V _{CHGIN} = 0V SYS switch closed, 2x buck regulators enabled, LDOs disabled. I _{SYS} = 0A, I _{B_OUT} = 0A		2.8	4.3	
		Power on, V _{CHGIN} = 0V SYS switch closed, 2x buck regulators enabled, LDO1 enabled, I _{SYS} = 0A, I _{B_OUT} = 0A, I _{L_OUT} = 0A		3.5	7	
		Power on, V _{CHGIN} = 0V SYS switch closed, 2x buck regulators enabled, 3x LDOs enabled, I _{SYS} = 0A, I _{B_OUT} = 0A, I _{L_OUT} = 0A		5.2		
BUCK REGULATOR 1 (V _{SYS} = +3.7V, L = 2.2μH, C = 2.2μF, V _{B1OUT} = 1.2V)						
Input Voltage	V _{IN_BUCK1}	Input voltage = V _{SYS}	2.7		5.5	V
Output Voltage	V _{OUT_BUCK1}	25mV step resolution	0.7		2.275	V
Output UVLO Voltage	V _{UVLO_BUCK1}	Note: For V _{OUT} < UVLO ZC is imposed. Falling edge (75mV typ hysteresis)		0.35	0.55	V
Quiescent Supply Current	I _{Q_BUCK1}	Buck enabled, I _{B1OUT} = 0mA, V _{SYS} = 3.7V, V _{B1OUT} = 1.2V (Note 2)		0.9	1.3	μA
Dropout Quiescent Supply Current	I _{QDO_BUCK1}	I _{B1OUT} = 0mA, (V _{SYS} - V _{OUT}) ≤ 0.1V		1.1		mA
Shutdown Supply Current with Active Discharge Enabled	I _{SD_BUCK1}	Buck1 disabled. Falling edge (75mV typ hysteresis)		60		μA
Output Accuracy	ACC _{BUCK1}	I _{B1OUT} = 1mA	-2.5		+2.5	%
Peak-to-Peak Ripple	V _{PPRIPPLE1}	Buck1ISet = 100mA, C _{OUT} = 2.2μF, I _{B1OUT} = 1mA		10		mV
I _{PEAK} Set Range	I _{PEAK_BUCK1}	25mA step resolution set by Buck1ISet[3:0].	50		375	mA

Electrical Characteristics (continued)

(V_{CHGIN} = 5.0V, V_{BAT} = 3.7V, T_A = -40°C to +85°C, all registers in their default state, unless otherwise noted. Typical values are at T_A = +25°C.) (Note 1)

PARAMETER	SYMBOL	CONDITIONS	MIN	TYP	MAX	UNITS
Load Regulation Error	V _{LOADR_BUCK1}	Buck1ISet = 150mA, Buck1IAdptEnb = 0, I _{B1OUT} = 300mA		-3		%
Line Regulation Error	V _{LINER_BUCK1}	V _{B1OUT} = 1.2V; V _{SYS} from 2.7V to 5.5V		3		mV
Maximum Operating Output Current	I _{OUT_BUCK1}	V _{SYS} = 3.7V, Buck1VSet = 1.2V, Buck1ISet = 200mA, Buck1IAdptEnb = 0, load regulation error = -5%	200	500		mA
B1OUT Pulldown Current	I _{LEAK_B1OUT}	Buck1 enabled		110		nA
B1OUT Pulldown Resistance	R _{PD_B1OUT}	Buck1 disabled, V _{B1OUT} = 1.2V		12		MΩ
pMOS On-Resistance	R _{ONP_BUCK1}	Buck1FFET = 0		0.27	0.5	Ω
		Buck1FFET = 1		0.55	1	Ω
nMOS On-Resistance	R _{ONN_BUCK1}	Buck1FFET = 0		0.24	0.45	Ω
		Buck1FFET = 1		0.43	0.9	Ω
Freewheeling On-Resistance	R _{ONFW_BUCK1}	V _{SYS} = 3.7V, V _{B1OUT} = 1.2V		7.3	13	Ω
Minimum T _{ON}	T _{ON_MIN}			40	80	ns
Maximum Duty Cycle	D _{MAX_BUCK1}	Buck1IAdptEnb = 0		98		%
Switching Frequency	f _{SW_BUCK1}	Load regulation error = -3%		3		MHz
Average Current During Short-Circuit to GND	I _{SHRT_BUCK1}	Buck1ISet = 150mA, Buck1IAdptEnb = 0, V _{B1OUT} = 0V		100		mA
BLX Leakage Current	I _{BLX_BUCK1}			0.005	1	μA
Active Discharge Current	I _{PD_BUCK1}	V _{B1OUT} = 1.2V		17		mA
Passive Discharge Resistance	R _{PD_BUCK1}	V _{B1OUT} = 1.2V		9		kΩ
Full Turn-On Time	t _{ON_BUCK1}	Time from enable to full current capability, Buck1Fst = 0		58		ms
Efficiency	Eff _{BUCK1}	I _{LOAD} = 10mA, Buck1ISet = 150mA, Inductor = BOURNS SRP2010- 2R2M, V _{B1OUT} = 1.2V		87		%
BLX Rising/Falling Slew Rate	SR _{BLX_BUCK1}	Buck1LowEMI = 0		2		V/ns
		Buck1LowEMI = 1		0.5		
Thermal-Shutdown Temperature	T _{SHDN_BUCK1}			140		°C
Thermal-Shutdown Temperature Hysteresis	T _{SHDN_HYST_BUCK1}			10		°C

Electrical Characteristics (continued)

($V_{CHGIN} = 5.0V$, $V_{BAT} = 3.7V$, $T_A = -40^\circ C$ to $+85^\circ C$, all registers in their default state, unless otherwise noted. Typical values are at $T_A = +25^\circ C$.) (Note 1)

PARAMETER	SYMBOL	CONDITIONS	MIN	TYP	MAX	UNITS
BUCK REGULATOR 2						
(V _{SYS} = +3.7V, L = 2.2μH, C = 2.2μF, V _{B2OUT} = 1.2V)						
Input Voltage	V _{IN_BUCK2}	Input voltage = V _{SYS}	2.7		5.5	V
Output Voltage	V _{OUT_BUCK2}	50mV step resolution	0.7		3.85	V
Output UVLO Voltage	V _{UVLO_BUCK2}	Note: For V _{OUT} < UVLO ZC is imposed. Falling edge (75mV typ hysteresis)		0.35	0.55	V
Quiescent Supply Current	I _{Q_BUCK2}	Buck enabled, I _{B2OUT} = 0mA, V _{SYS} = 3.7V, V _{B2OUT} = 1.2V (Note 2)		1	1.4	μA
Dropout Quiescent Supply Current	I _{QDO_BUCK2}	I _{B2OUT} = 0mA, V _{SYS} - V _{B2OUT} ≤ 0.1V		1.1		mA
Shutdown Supply Current with Active Discharge Enabled	I _{SD_BUCK2}	Buck1 disabled, Buck2ActDSC = 1.		60		μA
Output Accuracy	ACC _{BUCK2}	I _{B2OUT} = 1mA, V _{B2OUT} < 3.4V	-2.5		+2.5	%
Peak-to-Peak Ripple	V _{PPRIPPLE2}	Buck2ISet = 100mA, C _{OUT} = 2.2μF, I _{B2OUT} = 1mA		10		mV
I _{PEAK} Set Range	I _{PEAK_BUCK2}	25mA step resolution set by Buck2ISet[3:0].	50		375	mA
Load Regulation Error	V _{LOADR_BUCK2}	Buck2ISet = 150mA, Buck2IAdptEnb = 0, I _{B2OUT} = 300mA		-3		%
Line Regulation Error	V _{LINER_BUCK2}	V _{B2OUT} = 1.2V; V _{SYS} from 2.7V to 5.5V		3		mV
Maximum Operating Output Current	I _{OUT_BUCK2}	V _{SYS} = 3.7V, Buck2VSet = 1.2V, Buck2ISet = 200mA, Buck2IAdptEnb = 0, load regulation = -5%	200	500		mA
B2OUT Pulldown Current	I _{LEAK_B2OUT}	Buck2 enabled		220		nA
B2OUT Pulldown Resistance	R _{PD_B2OUT}	Buck2 disabled, V _{B2OUT} = 1.2V		6		MΩ
pMOS On-Resistance	R _{ONP_BUCK2}	Buck2FFET = 0		0.27	0.5	Ω
		Buck2FFET = 1		0.55	1	Ω
nMOS On-Resistance	R _{ONN_BUCK2}	Buck2FFET = 0		0.24	0.45	Ω
		Buck2FFET = 1		0.43	0.9	Ω
Freewheeling On-Resistance	R _{ONFW_BUCK2}	V _{SYS} = 3.7V, V _{B2OUT} = 1.2V		7.3	13	Ω

Electrical Characteristics (continued)

(V_{CHGIN} = 5.0V, V_{BAT} = 3.7V, T_A = -40°C to +85°C, all registers in their default state, unless otherwise noted. Typical values are at T_A = +25°C.) (Note 1)

PARAMETER	SYMBOL	CONDITIONS	MIN	TYP	MAX	UNITS
Minimum T _{ON}	T _{ON_MIN}			40	80	ns
Maximum Duty Cycle	D _{MAX_BUCK2}	Buck2IAdptEnb = 0		98		%
Switching Frequency	f _{SW_BUCK2}	Load regulation error = -3%		3		MHz
Average Current During Short-Circuit to GND	I _{SHRT_BUCK2}	Buck2ISet = 150mA, Buck2IAdptEnb = 0, V _{B2OUT} = 0V		100		mA
BLX Leakage Current	I _{BLX_BUCK2}			0.005	1	μA
Active Discharge Current	I _{PD_BUCK2}	V _{B2OUT} = 1.2V		17		mA
Passive Discharge Resistance	R _{PD_BUCK2}	V _{B2OUT} = 1.2V		9		kΩ
Full Turn-On Time	T _{ON_BUCK2}	Time from enable to full current capability, Buck2Fst = 0		58		ms
Efficiency	Eff _{BUCK2}	I _{LOAD} = 10mA, Buck2ISet = 150mA, Inductor = BOURNS SRP2010-2R2M, V _{B2OUT} = 1.2V		87		%
BLX Rising/Falling Slew Rate	SR _{BLX_BUCK2}	Buck2LowEMI = 0		2		V/ns
		Buck2LowEMI = 1		0.5		
Thermal-Shutdown Temperature	T _{SHDN_BUCK2}			140		°C
Thermal-Shutdown Temperature Hysteresis	T _{SHDN_HYST_BUCK2}			10		°C
LDO1 (C = 1μF, unless otherwise noted. Typical values are at V _{L1IN} = 3.7V, with I _{L1OUT} = 10mA, V _{L1OUT} = 3V.)						
Input Voltage	V _{INLDO1}	LDO mode		2.7	5.5	V
		Switch mode		1.2	5.5	V
Quiescent Supply Current	I _{Q_LDO1}	LDO enabled, I _{L1OUT} = 0μA		0.55	4	μA
		LDO enabled, I _{L1OUT} = 0μA, Switch mode		0.45		
Shutdown Supply Current with Active Discharge Enabled	I _{SD_LDO1}	LDO1 disabled. LDO1ActDSC=1.		55		μA
Maximum Output Current	I _{L1OUT_MAX}			100		mA
Output Voltage	V _{L1OUT}			0.8	3.6	V
Output Accuracy	ACC _{LDO1}	V _{L1IN} = (V _{L1OUT} + 0.5V) or higher, I _{L1OUT} = 100μA		-2.7	+2.7	%

Electrical Characteristics (continued)

(V_{CHGIN} = 5.0V, V_{BAT} = 3.7V, T_A = -40°C to +85°C, all registers in their default state, unless otherwise noted. Typical values are at T_A = +25°C.) (Note 1)

PARAMETER	SYMBOL	CONDITIONS	MIN	TYP	MAX	UNITS
Dropout Voltage	V _{DROP_LDO1}	V _{L1IN} = 3V, I _{L1OUT} = 100mA, LDO1VSet = 3V			102	mV
Line Regulation Error	V _{LINEREG_LDO1}	V _{L1IN} = (V _{L1OUT} + 0.5V) to 5.5V	-0.12	0.022	+0.12	%/V
Load Regulation Error	V _{LOADREG_LDO1}	I _{L1OUT} = 100μA to 100mA		0.002	0.005	%/mA
Line Transient	V _{LINETRAN_LDO1}	V _{L1IN} = 4V to 5V, 200ns rise time		±36		mV
		V _{L1IN} = 4V to 5V, 1μs rise time		±28		mV
Load Transient	V _{LOADTRAN_LDO1}	I _{L1OUT} = 0mA to 10mA, 200ns rise time		145		mV
		I _{L1OUT} = 0mA to 100mA, 200ns rise time		290		mV
Passive Discharge Resistance	R _{PD_LDO1}		5	10	16	KΩ
Active Discharge Current	I _{ADL_LDO1}	V _{L1IN} = 3.7V	7	20	37	mA
Switch Mode Resistance	R _{ON_LDO1}	V _{L1IN} = 2.7V, I _{L1OUT} = 100mA		0.5	0.85	Ω
		V _{L1IN} = 1.8V, I _{L1OUT} = 100mA		0.76	1.3	
		V _{L1IN} = 1.2V, I _{L1OUT} = 5mA		1.7	2.8	
Turn-On Time	t _{ON_LDO1}	I _{L1OUT} = 0mA, time from 10% to 90% of final value		1.6	3.7	ms
		I _{L1OUT} = 0mA, time from 10% to 90% of final value, Switch mode		0.25	0.65	
Short-Circuit Current Limit	I _{SHRT_LDO1}	V _{L1IN} = 2.7V, V _{L1OUT} = GND	150	345	550	mA
		V _{L1IN} = 2.7V, V _{L1OUT} = GND, Switch mode	150	335	550	mA
Thermal-Shutdown Temperature	T _{SHDN_LDO1}			150		°C
Thermal-Shutdown Temperature Hysteresis	T _{SHDN_HYST_LDO1}			16		°C
Output Noise	OUT _{NOISE}	10Hz to 100kHz, V _{L1IN} = 5V, V _{L1OUT} = 3.3V		110		μVrms
		10Hz to 100kHz, V _{L1IN} = 5V, V _{L1OUT} = 2.5V		95		
		10Hz to 100kHz, V _{L1IN} = 5V, V _{L1OUT} = 1.2V		60		
		10Hz to 100kHz, V _{L1IN} = 5V, V _{L1OUT} = 0.8V		60		

Electrical Characteristics (continued)

(V_{CHGIN} = 5.0V, V_{BAT} = 3.7V, T_A = -40°C to +85°C, all registers in their default state, unless otherwise noted. Typical values are at T_A = +25°C.) (Note 1)

PARAMETER	SYMBOL	CONDITIONS	MIN	TYP	MAX	UNITS
LDO2 (C = 1μF, unless otherwise noted. Typical values are at V _{L2IN} = 3.7V, with I _{L2OUT} = 10mA, V _{L2OUT} = 3V.)						
Input Voltage	V _{INLDO2}	LDO mode	1.71		5.5	V
		Switch mode	1.2		5.5	V
Quiescent Supply Current	I _{Q_LDO2}	I _{L2OUT} = 0μA		1	5.1	μA
		I _{L2OUT} = 0μA, Switch mode		0.5		
Quiescent Supply Current in Dropout	I _{QDO_LDO2}	I _{L2OUT} = 0μA, V _{L2IN} = 2.9V, LDO2VSet = 3V.		1.8		μA
Shutdown Supply Current with Active Discharge Enabled	I _{SD_LDO2}	LDO2 disabled. LDO2ActDSC=1.		54		μA
Maximum Output Current	I _{L2OUT_MAX}	V _{L2IN} ≥ 2.7V	100			mA
		V _{L2IN} = 1.8V or lower	50			mA
Output Voltage	V _{L2OUT}		0.9		4	V
Output Accuracy	ACC _{LDO2}	V _{L2IN} = (V _{L2OUT} + 0.5V) or higher, I _{L2OUT} = 100μA	-2.7		+2.7	%
Dropout Voltage	V _{DROP_LDO2}	V _{L2IN} = 3V, I _{L2OUT} = 100mA, LDO2VSet = 3V			100	mV
Line Regulation Error	V _{LINEREG_LDO2}	V _{L2IN} = (V _{L2OUT} + 0.5V) to 5.5V	-0.4	+0.05	+0.4	%/V
Load Regulation Error	V _{LOADREG_LDO2}	I _{L2OUT} = 100μA to 100mA		0.001	0.005	%/mA
Line Transient	V _{LINETRAN_LDO2}	V _{L2IN} = 4V to 5V, 200ns rise time		±35		mV
		V _{L2IN} = 4V to 5V, 1μs rise time		±25		mV
Load Transient	V _{LOADTRAN_LDO2}	I _{L2OUT} = 0mA to 10mA, 200ns rise time		100		mV
		I _{L2OUT} = 0mA to 100mA, 200ns rise time		200		mV
Passive Discharge Resistance	R _{PD_LDO2}		5	10	16	KΩ
Active Discharge Current	I _{ADL_LDO2}	V _{L2IN} = 3.7V	7	20	37	mA
Switch Mode Resistance	R _{ON_LDO2}	V _{L2IN} = 2.7V, I _{L2OUT} = 100mA		0.46	0.76	Ω
		V _{L2IN} = 1.8V, I _{L2OUT} = 50mA		0.7	1.15	
		V _{L2IN} = 1.2V, I _{L2OUT} = 5mA		1.7	2.6	
Turn-On Time	t _{ON_LDO2}	I _{L2OUT} = 0mA, time from 10% to 90% of final value		1.5	3.7	ms
		I _{L2OUT} = 0mA, time from 10% to 90% of final value, Switch mode		0.25	0.65	

Electrical Characteristics (continued)

(V_{CHGIN} = 5.0V, V_{BAT} = 3.7V, T_A = -40°C to +85°C, all registers in their default state, unless otherwise noted. Typical values are at T_A = +25°C.) (Note 1)

PARAMETER	SYMBOL	CONDITIONS	MIN	TYP	MAX	UNITS
Short-Circuit Current Limit	I _{SHRT_LDO2}	V _{L2IN} = 2.7V, V _{L2OUT} = GND	140	340	600	mA
		V _{L2IN} = 2.7V, V _{L2OUT} = GND, Switch mode	140	330	600	mA
Thermal-Shutdown Temperature	T _{SHDN_LDO2}			150		°C
Thermal-Shutdown Temperature Hysteresis	T _{SHDN_HYST_LDO2}			21		°C
Output Noise	OUT _{NOISE}	10Hz to 100kHz, V _{L2IN} = 5V, V _{L2OUT} = 3.3V		150		μVrms
		10Hz to 100kHz, V _{L2IN} = 5V, V _{L2OUT} = 2.5V		125		
		10Hz to 100kHz, V _{L2IN} = 5V, V _{L2OUT} = 1.2V		90		
		10Hz to 100kHz, V _{L2IN} = 5V, V _{L2OUT} = 0.9V		80		
L2IN UVLO	V _{UVLO_LDO2}	V _{L2IN} Falling	1.14	1.38		V
		V _{L2IN} Rising		1.4	1.64	
LDO3 (C = 1μF, unless otherwise noted. Typical values are at V _{L3IN} = 3.7V, with I _{L3OUT} = 10mA, V _{L3OUT} = 3V.)						
Input Voltage	V _{INLDO3}	LDO mode	1.71		5.5	V
		Switch mode	1.2		5.5	V
Quiescent Supply Current	I _{Q_LDO3}	I _{L3OUT} = 0μA		1	5.1	μA
		I _{L3OUT} = 0μA, Switch mode		0.5		
Quiescent Supply Current in Dropout	I _{QDO_LDO3}	I _{L3OUT} = 0μA, V _{L3IN} = 2.9V, LDO3VSet = 3V.		1.8		μA
Shutdown Supply Current with Active Discharge Enabled	I _{SD_LDO3}	LDO3 disabled. LDO3ActDSC=1.		54		μA
Maximum Output Current	I _{L3OUT_MAX}	V _{L3IN} ≥ 2.7V	100			mA
		V _{L3IN} = 1.8V or lower	50			mA
Output Voltage	V _{L3OUT}		0.9		4	V
Output Accuracy	ACC _{LDO3}	V _{L3IN} = (V _{L3OUT} + 0.5V) or higher, I _{L3OUT} = 100μA	-2.7		+2.7	%
Dropout Voltage	V _{DROP_LDO3}	V _{L3IN} = 3V, I _{L3OUT} = 100mA, LDO3VSet = 3V			100	mV

Electrical Characteristics (continued)

(V_{CHGIN} = 5.0V, V_{BAT} = 3.7V, T_A = -40°C to +85°C, all registers in their default state, unless otherwise noted. Typical values are at T_A = +25°C.) (Note 1)

PARAMETER	SYMBOL	CONDITIONS	MIN	TYP	MAX	UNITS
Line Regulation Error	V _{LINEREG_LDO3}	V _{L3IN} = (V _{L3OUT} + 0.5V) to 5.5V	-0.4	+0.05	+0.4	%/V
Load Regulation Error	V _{LOADREG_LDO3}	I _{L3OUT} = 100μA to 100mA		0.001	0.005	%/mA
Line Transient	V _{LINETRAN_LDO3}	V _{L3IN} = 4V to 5V, 200ns rise time		±35		mV
		V _{L3IN} = 4V to 5V, 1μs rise time		±25		mV
Load Transient	V _{LOADTRAN_LDO3}	I _{L3OUT} = 0mA to 10mA, 200ns rise time		100		mV
		I _{L3OUT} = 0mA to 100mA, 200ns rise time		200		mV
Passive Discharge Resistance	R _{PD_LDO3}		5	10	16	KΩ
Active Discharge Current	I _{ADL_LDO3}	V _{L3IN} = 3.7V	7	20	37	mA
Switch Mode Resistance	R _{ON_LDO3}	V _{L3IN} = 2.7V, I _{L3OUT} = 100mA		0.46	0.76	Ω
		V _{L3IN} = 1.8V, I _{L3OUT} = 100mA		0.7	1.15	
		V _{L3IN} = 1.2V, I _{L3OUT} = 5mA		1.7	2.6	
Turn-On Time	t _{ON_LDO3}	I _{L3OUT} = 0mA, time from 10% to 90% of final value		1.5	3.7	ms
		I _{L3OUT} = 0mA, time from 10% to 90% of final value, Switch mode		0.25	0.65	
Short-Circuit Current Limit	I _{SHRT_LDO3}	V _{L3IN} = 2.7V, V _{L3OUT} = GND	140	340	600	mA
		V _{L3IN} = 2.7V, V _{L3OUT} = GND, Switch mode	140	330	600	mA
Thermal-Shutdown Temperature	T _{SHDN_LDO3}			150		°C
Thermal-Shutdown Temperature Hysteresis	T _{SHDN_HYST_LDO3}			21		°C
Output Noise	OUT _{NOISE}	10Hz to 100kHz, V _{L3IN} = 5V, V _{L3OUT} = 3.3V		150		μVrms
		10Hz to 100kHz, V _{L3IN} = 5V, V _{L3OUT} = 2.5V		125		
		10Hz to 100kHz, V _{L3IN} = 5V, V _{L3OUT} = 1.2V		80		
		10Hz to 100kHz, V _{L3IN} = 5V, V _{L3OUT} = 0.9V		60		
L3IN UVLO	V _{UVLO_LDO3}	V _{L3IN} Falling	1.14	1.38		V
		V _{L3IN} Rising		1.4	1.64	

Electrical Characteristics (continued)

(V_{CHGIN} = 5.0V, V_{BAT} = 3.7V, T_A = -40°C to +85°C, all registers in their default state, unless otherwise noted. Typical values are at T_A = +25°C.) (Note 1)

PARAMETER	SYMBOL	CONDITIONS	MIN	TYP	MAX	UNITS
CHGIN TO SYS PATH (V _{CHGIN} = 5.0V, V _{SYS} = V _{SYS_REG})						
Allowed CHGIN Input Voltage Range	V _{CHGIN_RNG}		-5.5		28	V
V _{CHGIN} Detect Threshold	V _{CHGIN_DET}	Rising	3.8	3.9	4.1	V
		Falling	3.0	3.1	3.2	
V _{CHGIN} Overvoltage Threshold	V _{CHGIN_OV}	Rising	7.2	7.5	7.8	V
V _{CHGIN} Overvoltage Threshold Hysteresis	V _{CHGIN_OV_HYS}			200		mV
V _{CHGIN} Valid Trip Point	V _{CHGIN-SYS_TP}	V _{CHGIN} – V _{SYS} , Rising, V _{BAT} = 4V	+30	+145	+290	mV
V _{CHGIN} Valid Trip Point Hysteresis	V _{CHGIN-SYS_TP_HYS}			275		mV
Input Limiter Current	I _{LIM}	ILimCntl[1:0] = 00		0		mA
		ILimCntl[1:0] = 01		90	100	
		ILimCntl[1:0] = 10		450	550	
		ILimCntl[1:0] = 11		1000		
Internal CAP Regulator	V _{CAP}	V _{CHGIN} = 5V	3.9	4.2	4.7	V
CHGIN-SYS Regulation Voltage	V _{CHGIN-SYS}	V _{CHGIN} = 4V, I _{SYS} = 1mA		40		mV
CHGIN to SYS On-Resistance	R _{CHGIN-SYS}	V _{CHGIN} = 4.4V, I _{SYS} = 500mA		370	660	mΩ
Thermal-Shutdown Temperature	T _{CHGIN_SHDN}	(Note 3)		+150		°C
Thermal-Shutdown Temperature Hysteresis	T _{CHGIN_SHDN_HYS}			30		°C
Input Current Soft-Start Time	t _{SFST_LIM}			1		ms
Internal Supply Switchover Threshold	V _{CCINT_TH}	V _{CHGIN} = V _{CAP} rising, V _{BAT} = 4.2V	2.5	2.8	3.0	V

Electrical Characteristics (continued)

(V_{CHGIN} = 5.0V, V_{BAT} = 3.7V, T_A = -40°C to +85°C, all registers in their default state, unless otherwise noted. Typical values are at T_A = +25°C.) (Note 1)

PARAMETER	SYMBOL	CONDITIONS	MIN	TYP	MAX	UNITS
SYS, BATTERY, AND VCCINT UVLOs						
SYS UVLO Threshold	V _{SYSUVLO_R}	Rising		3	3.06	V
	V _{SYSUVLO_F}	Falling	2.92	2.98	3.04	
SYS UVLO Threshold Hysteresis	V _{SYSUVLO_HYS}	Hysteresis		26		mV
SYS UVLO Falling Debounce Time	t _{SYSUVLO_FDEB}	SYS Falling		20		μs
VCCINT UVLO Threshold (POR)	V _{UVLO}	VCCINT Rising	0.8	1.82	2.6	V
VCCINT UVLO Threshold Hysteresis	V _{UVLO_HYS}			140		mV
BAT UVLO Threshold	V _{BAT_UVLO}	Rising (Valid only when CHGIN is present. When V _{BAT} < V _{BAT_UVLO} , the BAT-SYS switch opens and BAT is connected to SYS through a diode.)	1.9	2.05	2.2	V
BAT UVLO Threshold Hysteresis	V _{BAT_UVLO_HYS}	Hysteresis		50		mV
BATTERY CHARGER (See Figure 5a and Figure 5b)						
(V _{BAT} = 4.2V. Typical values are at V _{CHGIN} = 5.0V, V _{SYS} = V _{SYS_REG})						
Allowed BAT Voltage Range	V _{BAT_RNG}		0		5.5	V
BAT to SYS On-Resistance	R _{BAT-SYS}	V _{BAT} = 4.2V, I _{BAT} = 300mA		80	140	mΩ
Current Reduce Thermal Threshold Temperature	T _{CHG_LIM}	(Note 4)		120		°C
BAT-to-SYS Switch-On Threshold	V _{BAT-SYS-ON}	SYS falling	10	22	35	mV
BAT-to-SYS Switch-Off Threshold	V _{BAT-SYS-OFF}	SYS rising	-3	-1.5	0	mV
SYS-BAT Regulation Voltage	V _{SYS_REG}	V _{CHGIN} = 5V, I _{SYS} = 1mA	V _{BatReg} + 140mV	V _{BatReg} + 200mV	V _{BatReg} + 260mV	V

Electrical Characteristics (continued)

(V_{CHGIN} = 5.0V, V_{BAT} = 3.7V, T_A = -40°C to +85°C, all registers in their default state, unless otherwise noted. Typical values are at T_A = +25°C.) (Note 1)

PARAMETER	SYMBOL	CONDITIONS	MIN	TYP	MAX	UNITS
SYS Threshold Voltage Charger Limiting Current (Note 5)	V _{SYS_LIM}	SysMin = 000, V _{BAT} > 3.6V		V _{BAT} ⁺ 0.1		V
		SysMin = 000, V _{BAT} < 3.4V		3.6		
		SysMin = 001, V _{BAT} < 3.4V		3.7		
		SysMin = 010, V _{BAT} < 3.4V		3.8		
		SysMin = 011, V _{BAT} < 3.4V		3.9		
		SysMin = 100, V _{BAT} < 3.4V	3.86	4	4.14	
		SysMin = 101, V _{BAT} < 3.4V		4.1		
		SysMin = 110, V _{BAT} < 3.4V		4.2		
		SysMin = 111, V _{BAT} < 3.4V		4.3		
Charger Current Soft-Start Time	t _{CHG_SOFT}			1		ms
PRECHARGE						
Precharge Current	I _{PCHG}	IPChg = 00		5		%I _{FChg}
		IPChg = 01	9	10	11	
		IPChg = 10		20		
		IPChg = 11		30		
Prequalification Threshold	V _{BAT_PChg}	VPChg = 000		2.1		V
		VPChg = 001	2.15	2.25	2.35	
		VPChg = 010		2.40		
		VPChg = 011		2.55		
		VPChg = 100		2.7		
		VPChg = 101		2.85		
		VPChg = 110		3.0		
VPChg = 111		3.15				
Prequalification Threshold Hysteresis	V _{BAT_PChg_HYS}			90		mV

Electrical Characteristics (continued)

(V_{CHGIN} = 5.0V, V_{BAT} = 3.7V, T_A = -40°C to +85°C, all registers in their default state, unless otherwise noted. Typical values are at T_A = +25°C.) (Note 1)

PARAMETER	SYMBOL	CONDITIONS	MIN	TYP	MAX	UNITS	
FAST CHARGE							
SET Current Gain Factor	K _{SET}			2000		A/A	
SET Regulation Voltage	V _{SET}			1		V	
Fast-Charge Current	I _{FChg}	R _{SET} = 400kΩ		5		mA	
		R _{SET} = 40kΩ	45	50	55		
		R _{SET} = 4kΩ	450	500	550		
Fast-Charge Current Accuracy (Note 6)	I _{FChg_ACC}	R _{SET} Range = 4kΩ to 40kΩ	-10		+10	%	
MAINTAIN CHARGE							
Charge Done Qualification	I _{Chg_DONE}	ChgDone = 00		5		%I _{FChg}	
		ChgDone = 01	8.5	10	11.5		
		ChgDone = 10		20			
		ChgDone = 11		30			
BAT Regulation Voltage (Note 7)	V _{BatReg}	BatReg = 0000		4.05		V	
		BatReg = 0001		4.10			
		BatReg = 0010		4.15			
		BatReg = 0011	T _A = +25°C	4.179	4.2		4.221
			T _A = 0 to +45C	4.168	4.2		4.232
		BatReg = 0100		4.25			
		BatReg = 0101		4.3			
		BatReg = 0110		4.35			
		BatReg = 0111		4.4			
		BatReg = 1000		4.45			
		BatReg = 1001		4.5			
		BatReg = 1010		4.55			
		BatReg = 1011		4.6			
BAT Recharge Threshold	V _{BatReChg}	BatReChg = 00		V _{BatReg} - 70		mV	
		BatReChg = 01		V _{BatReg} - 120			
		BatReChg = 10		V _{BatReg} -170			
		BatReChg = 11		V _{BatReg} -220			

Electrical Characteristics (continued)

(V_{CHGIN} = 5.0V, V_{BAT} = 3.7V, T_A = -40°C to +85°C, all registers in their default state, unless otherwise noted. Typical values are at T_A = +25°C.) (Note 1)

PARAMETER	SYMBOL	CONDITIONS	MIN	TYP	MAX	UNITS
CHARGER TIMER						
Maximum Prequalification Time	t _{PChg}	PChgTmr = 00		30		min
		PChgTmr = 01		60		
		PChgTmr = 10		120		
		PChgTmr = 11		240		
Maximum Fast-Charge Time	t _{FChg}	FChgTmr = 00		75		min
		FChgTmr = 01		150		
		FChgTmr = 10		300		
		FChgTmr = 11		600		
Maintain-Charge Time	t _{TOChg}	TOChgTmr = 00		0		min
		TOChgTmr = 01		15		
		TOChgTmr = 10		30		
		TOChgTmr = 11		60		
Timer Accuracy	t _{CHG_ACC}		-10		+10	%
Timer Extend Threshold	TIMEXD_THRES	If charge current is reduced due to ILIM or TDIE this is the percentage of charge current below which timer clock operates at half speed		50		%I _{FChg}
Timer Suspend Threshold	TIMSUS_THRES	If charge current is reduced due to ILIM or TDIE this is the percentage of charge current below which timer clock pauses		20		%I _{FChg}
THERMISTOR MONITOR AND NTC DETECTION						
THM Hot Threshold	T ₄	V _{THM} falling	30.9	32.9	34.9	%CAP
		V _{THM} falling	21.3	23.3	25.3	
THM Warm Threshold	T ₃	V _{THM} falling	48	50	52	
		V _{THM} falling	30.9	32.9	34.9	
THM Cool Threshold	T ₂	V _{THM} rising	62.5	64.5	66.5	
THM Cold Threshold	T ₁	V _{THM} rising	71.9	73.9	75.9	
THM Disable Threshold	THMDIS	V _{THM} rising	91	93	95	
THM Threshold Hysteresis	THMHYS			60		mV
THM Input Leakage	I _{LKG_THM}		-1		1	μA

Electrical Characteristics (continued)

(V_{CHGIN} = 5.0V, V_{BAT} = 3.7V, T_A = -40°C to +85°C, all registers in their default state, unless otherwise noted. Typical values are at T_A = +25°C.) (Note 1)

PARAMETER	SYMBOL	CONDITIONS	MIN	TYP	MAX	UNITS
START UP TIMING (See Figure 2)						
Boot Delay	t _{RST}	BootDly = 00		80		ms
		BootDly = 01		120		
		BootDly = 10		220		
		BootDly = 11		420		
Boot Delay Timer Accuracy	t _{RST_ACC}		-10		10	%
DIGITAL SIGNALS						
Input Logic-High (SDA, SCL, MPC0, MPC1, PFN1, PFN2)	V _{IH}		1.4			V
Input Logic-Low (SDA, SCL, MPC0, MPC1, PFN1, PFN2)	V _{IL}				0.5	V
Output Logic-Low (SDA, RST, INT, LED, PFN2)	V _{OL}	I _{OL} = 4mA			0.4	V
High Level Leakage Current (SDA, RST, INT, LED, PFN2)	I _{LK}				1	μA
SCL Clock Frequency	f _{SCL}				400	kHz
Bus Free Time Between a STOP and START Condition	t _{BUF}		1.3			μs
START Condition (Repeated) Hold Time	t _{HD:STA}	(Note 8)	0.6			μs
Low Period of SCL Clock	t _{LOW}		1.3			μs
High Period of SCL Clock	t _{HIGH}		0.6			μs
Setup Time for a Repeated START Condition	t _{SU:STA}		0.6			μs
Data Hold Time	t _{HD:DAT}	(Note 9)	0		0.9	μs
Data Setup Time	t _{SU:DAT}	(Note 9)	100			ns
Setup Time for STOP Condition	t _{SU:STO}		0.6			μs
Spike Pulse Widths Suppressed by Input Filter	t _{SP}	(Note 10)		50		ns

Electrical Characteristics (continued)

(V_{CHGIN} = 5.0V, V_{BAT} = 3.7V, T_A = -40°C to +85°C, all registers in their default state, unless otherwise noted. Typical values are at T_A = +25°C.) (Note 1)

- Note 1:** All devices are 100% production tested at T_A = +25°C. Limits over the operating temperature range guaranteed by design.
- Note 2:** This value is included in the I_{BAT} quiescent current values for the ON states.
- Note 3:** When the die temperature exceeds T_{CHGIN_SHDN}, the CHGIN to SYS path opens, and the charger is turned off.
- Note 4:** When the die temperature exceeds T_{CHG_LIM}, the charger current starts to decrease.
- Note 5:** This is the threshold at which the charger starts to limit the current due to SYS dropping; if V_{SYS} drops below this value the charger will not move to maintain charge.
- Note 6:** Fast charge current accuracy tested only at 50mA and 500mA, all other values guaranteed by design.
- Note 7:** Values over temperature are not production tested and guaranteed by characterization.
- Note 8:** f_{SCL} must meet the minimum clock low time plus the rise/fall times.
- Note 9:** The maximum t_{HD:DAT} has to be met only if the device does not stretch the low period (t_{LOW}) of the SCL signal.
- Note 10:** Filters on SDA and SCL suppress noise spikes at the input buffers and delay the sampling instant.

Typical Operating Characteristics

(V_{BAT} = 3.7V, V_{CHGIN} = 0V, registers in their default state, T_A = +25°C, unless otherwise noted.)

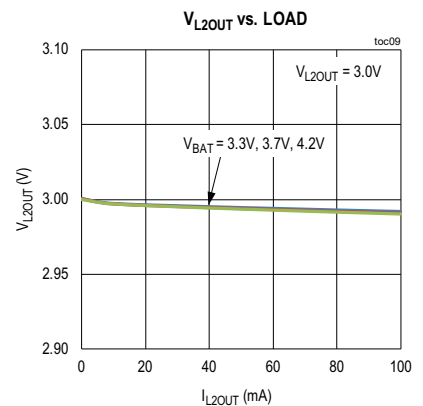
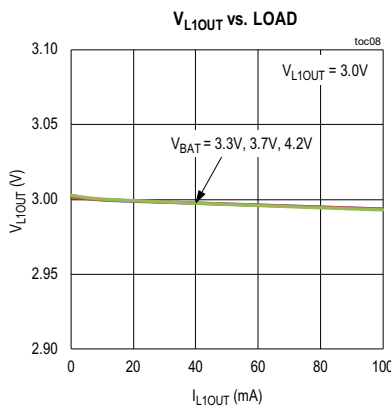
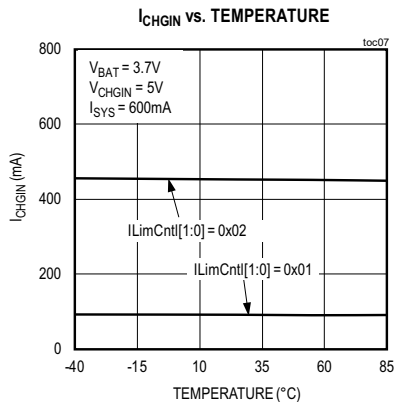
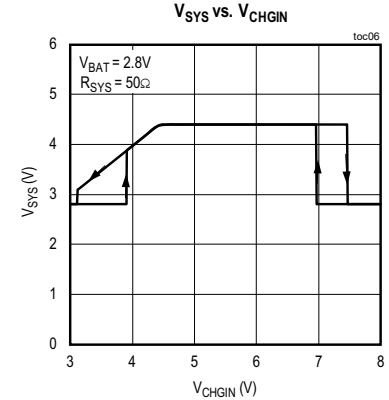
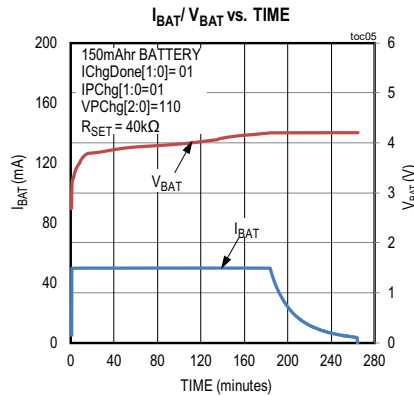
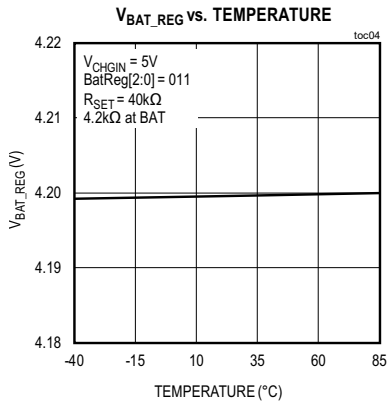
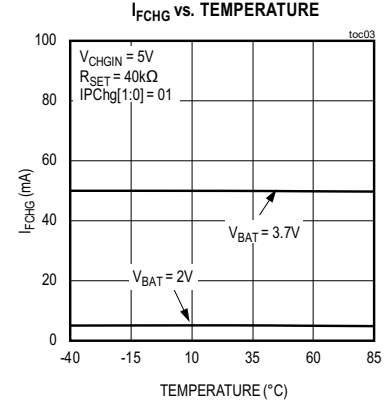
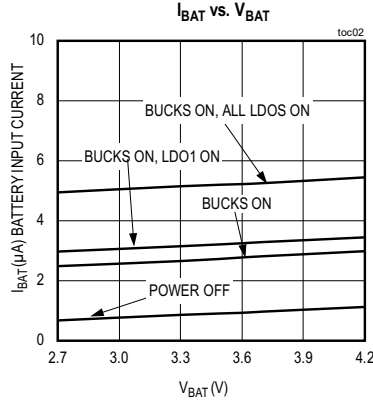
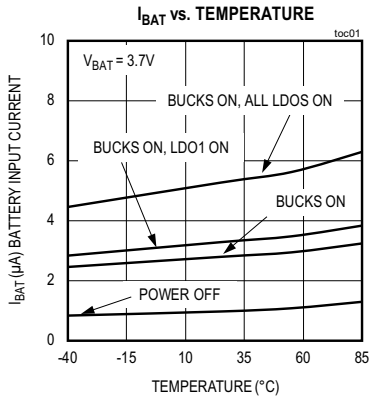

Typical Operating Characteristics (continued)

(V_{BAT} = 3.7V, V_{CHGIN} = 0V, registers in their default state, T_A = +25°C, unless otherwise noted.)

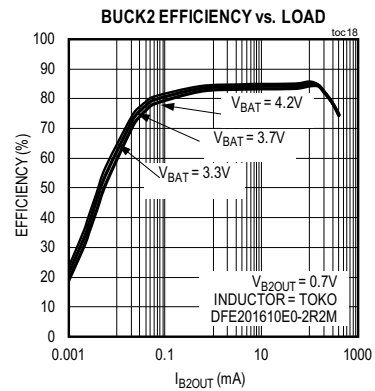
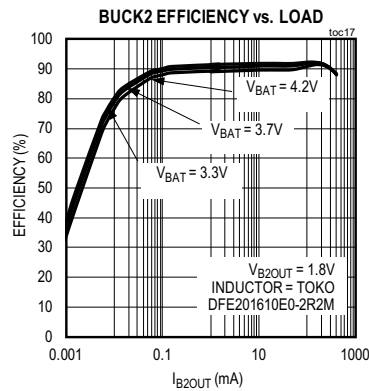
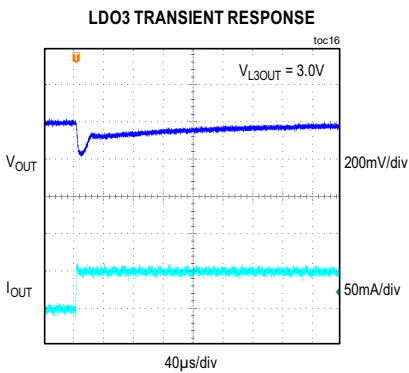
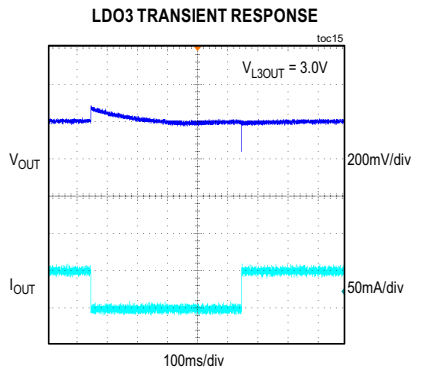
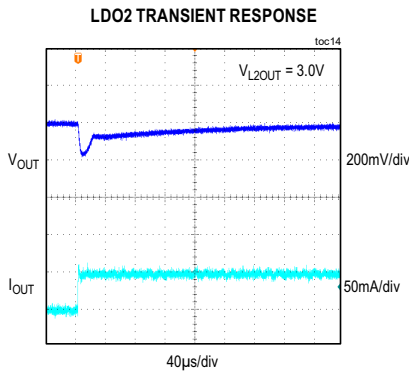
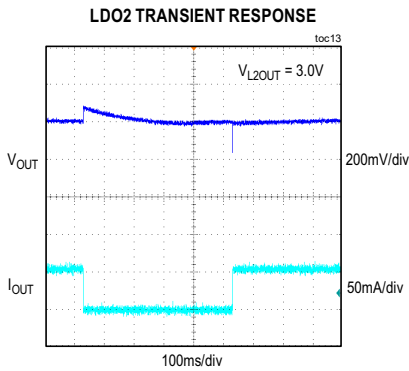
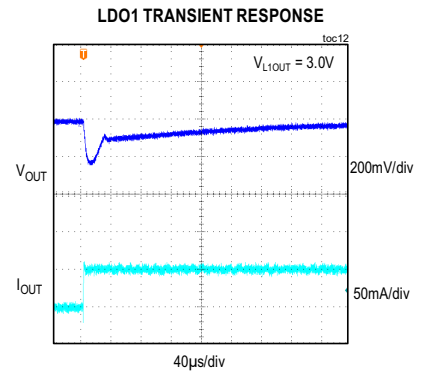
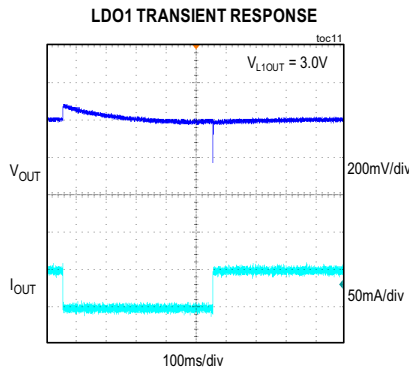
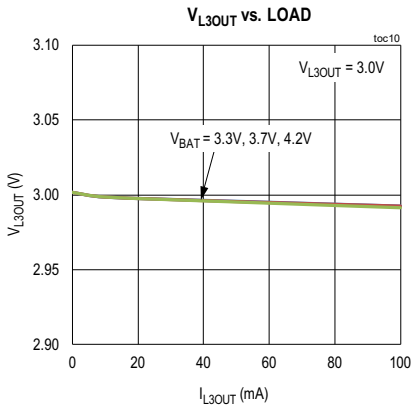

Typical Operating Characteristics (continued)

(V_{BAT} = 3.7V, V_{CHGIN} = 0V, registers in their default state, T_A = +25°C, unless otherwise noted.)

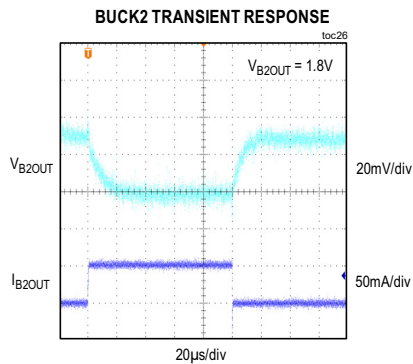
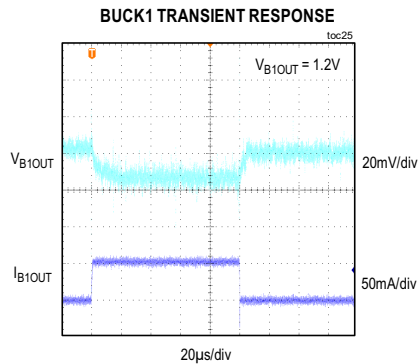
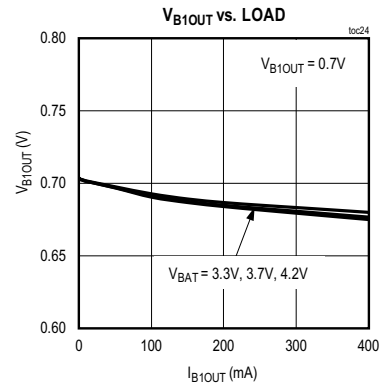
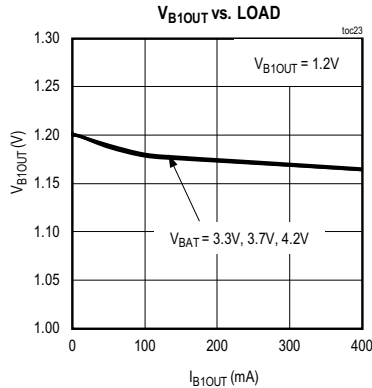
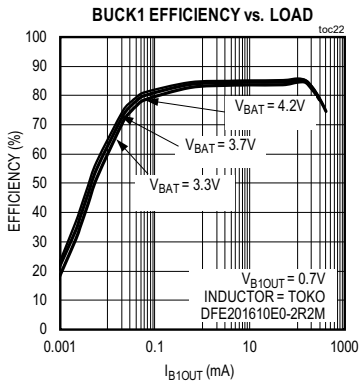
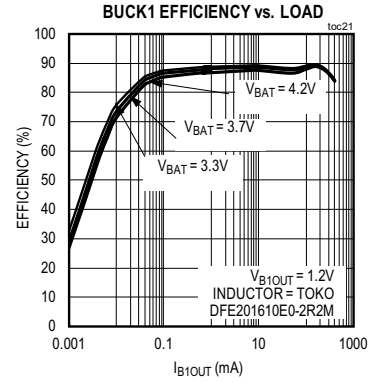
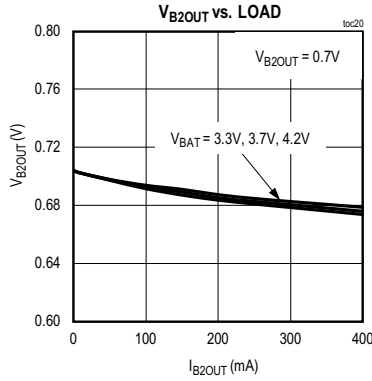
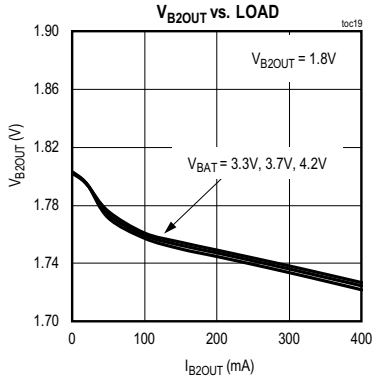

Bump Configuration

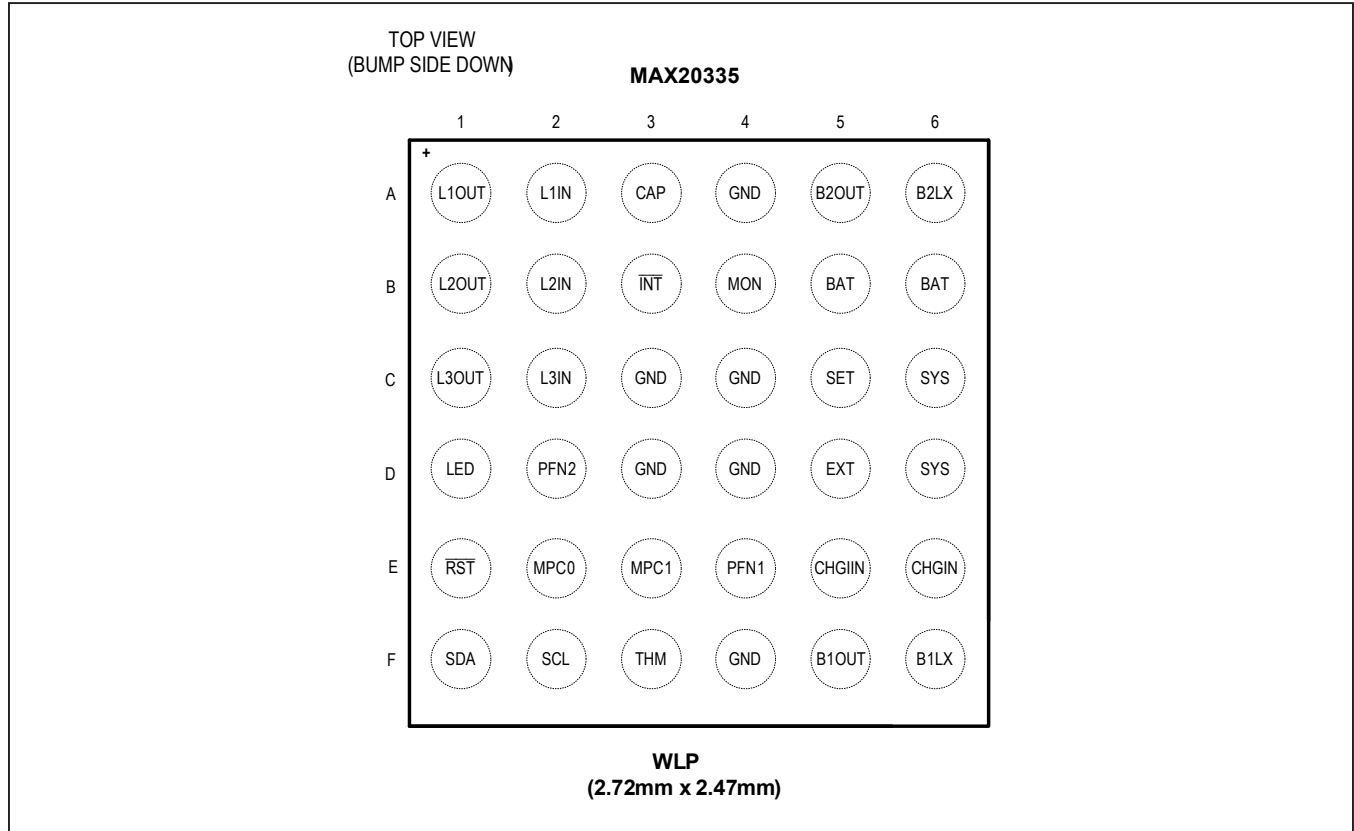

Bump Description

BUMP	NAME	FUNCTION
A1	L1OUT	LDO1 Output. Bypass with a minimum 1µF capacitor to GND.
A2	L1IN	LDO1 Input
A3	CAP	Bypass for Internal LDO. Bypass with a 1µF capacitor to GND.
A4, C3, C4 D3, D4, F4	GND	Ground
A5	B2OUT	0.7V to 3.85V Buck Regulator Output Feedback. Bypass with a 10µF capacitor to GND.
A6	B2LX	0.7V to 3.85V Buck Regulator Switch. Connect 2.2µH inductor to B2OUT.
B1	L2OUT	LDO2 Output. Bypass with a minimum 1µF capacitor to GND.
B2	L2IN	LDO2 Input
B3	INT	Open-Drain, Active-Low Interrupt Output.
B4	MON	Voltage Monitor Pin
B5, B6	BAT	Battery Connection. Connect BAT to a positive battery terminal, bypass BAT with a minimum 1µF capacitor to GND.

Bump Description (continued)

PIN	NAME	FUNCTION
C1	L3OUT	LDO3 Output. Bypass with a minimum 1μF capacitor to GND.
C2	L3IN	LDO3 Input
C5	SET	External Resistor For Battery Charge Current Level Setting. Do not connect any external capacitance on this pin; maximum allowed capacitance ($C_{SET} < 5\mu s/R_{SET}$) pF.
C6, D6	SYS	System Load Connection. Connect SYS to the system load. Bypass SYS with a minimum 10μF low-ESR ceramic capacitor to GND.
D1	LED	LED Open-Drain Pulldown Current. Add an external current limiting pullup resistor.
D2	PFN2	Power Function Control Input/Output. Programmable functionality via PwrFnMode. See Table 1.
D5	EXT	Push-Pull Gate Drive for Optional External pFET from BAT-to-SYS. Output is pulled to GND when charger is disconnected and internal BAT-SYS FET is switched on. Otherwise, this output is pulled high to the SYS voltage.
E1	\overline{RST}	Power-On Reset Output. Active-low, open-drain.
E2	MPC0	Multipurpose Configuration Input 0
E3	MPC1	Multipurpose Configuration Input 1
E4	PFN1	Power Function Control Input. Programmable functionality via PwrFnMode. See Table 1.
E5, E6	CHGIN	-5.5V/+28V Protected Charger Input. Bypass CHGIN with 1μF capacitor to GND.
F1	SDA	Open-Drain, I ² C Serial Data Input/Output.
F2	SCL	I ² C Serial Clock Input
F3	THM	Battery Temperature Thermistor Measurement Connection. Connect a 10kΩ resistor from THM to CAP and a 10kΩ, 3380β NTC thermistor from THM to GND.
F5	B1OUT	0.7V to 2.275V Buck Regulator Output Feedback. Bypass B1OUT with a 10μF capacitor to GND.
F6	B1LX	0.7V to 2.275V Buck Regulator Switch Terminal. Connect B1LX to B1OUT with a 2.2μH inductor.

Note: All capacitance values listed in this document refer to effective capacitance. Be sure to specify capacitors that will meet these requirements under typical system operating conditions taking into consideration the effects of voltage and temperature.

Block Diagram

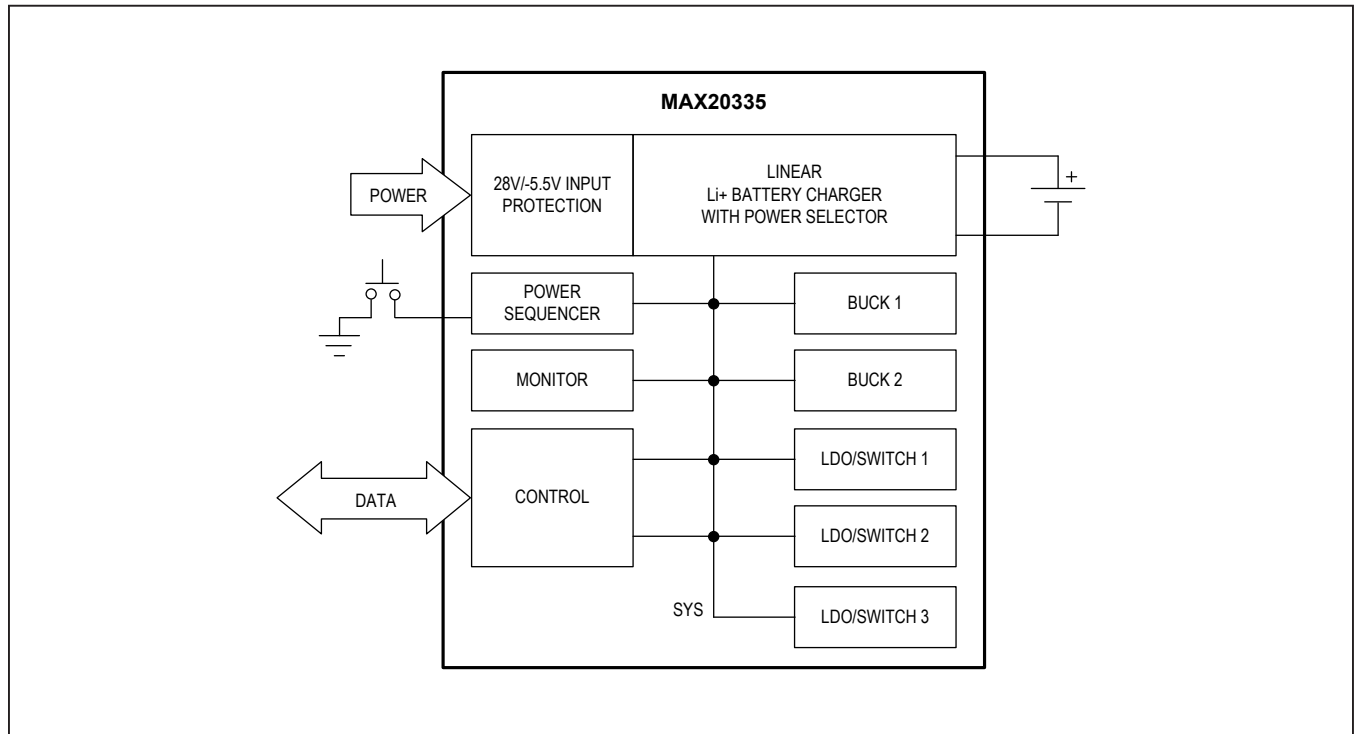

Detailed Description

Power Regulation

The MAX20335 family includes two high-efficiency, low quiescent current buck regulators, and three low quiescent current linear regulators that are also configurable as power switches. Excellent light-load efficiency allows the switching regulators to run continuously without significant energy cost.

Power On/Off and Reset Control

The behavior of power function control pins (PFN1 and PFN2) is preconfigured to support one of the multiple types of wearable application cases. [Table 1](#) describes the behavior of the PFN1 and PFN2 pins based on the PwrRstCfg[3:0] bits and [Figure 1](#) shows basic flow diagrams associated with each mode.

A Soft-Reset generates a 10ms logic low pulse at \overline{RST} and resets all registers to their default values. A Hard-Reset initiates a complete Power-On Reset sequence and generates a 50ms logic-low pulse at \overline{RST} .

Table 1. Power Function Input Control Modes

PwrRstCfg[3:0]**	PFN1**	PFN1 PU/PD PFNxResEna = 1	PFN2**	PFN2 PU/PD PFNxResEna = 1	Available PwrCmd		
					OFF	HARD	SOFT
On/ $\overline{\text{Off}}$	ENABLE	PULLDOWN	Manual $\overline{\text{Reset}}$	PULLUP*	NO	NO	YES
	On/Off Mode with 10ms debounce. PFN1 is the active-high on/off control input. PFN2 is the active-low soft-reset input.						
$\overline{\text{On}}$ /Off	DISABLE	PULLUP*	Manual $\overline{\text{Reset}}$	PULLUP*	NO	NO	YES
	On/Off Mode with 10ms debounce. PFN1 is the active-low on/off control. PFN2 is the active-low soft-reset input.						
AON	Hard-Reset on PFN1 Rising	PULLDOWN	Soft-Reset on PFN2 Rising	PULLDOWN	YES	YES	YES
	Always-On Mode. A rising edge on PFN1 generates a hard reset after a 200ms delay. A rising edge on PFN2 generates a soft-reset after a 200ms delay. In this mode, the device can only enter the off state by writing to the PwrCmd register.						
$\overline{\text{AON}}$	Hard-Reset on PFN1 Falling	PULLUP*	Soft-Reset on PFN2 Falling	PULLUP*	YES	YES	YES
	Always-On Mode. A falling edge on PFN1 generates a hard-reset after a 200ms delay. A falling edge on PFN2 generates a soft-reset after a 200ms delay. In this mode, the device can only enter the off state by writing to the PwrCmd register.						
CR High	Hard-Reset on CHGIN insertion When PFN1 High	PULLDOWN	Soft-Reset CHGIN Insertion When PFN2 High	PULLDOWN	YES	YES	YES
	Charger Reset High Mode. When PFN1 is high, a CHGIN insertion generates a hard-reset after a 200ms delay. When PFN2 is high, a CHGIN insertion generates a soft-reset after a 200ms delay. In this mode, the device can only enter the off state by writing to the PwrCmd register.						
CR Low	Hard-Reset on CHGIN Insertion When PFN1 low	PULLUP*	Soft-Reset on CHGIN Insertion When PFN2 Low	PULLUP*	YES	YES	YES
	Charger Reset Low Mode. When PFN1 is low, a CHGIN insertion generates a Hard-Reset after a 200ms delay. When PFN2 is low, a CHGIN insertion generates a Soft-Reset after a 200ms delay. In this mode, the device can only enter the off state by writing to the PwrCmd register.						
$\overline{\text{KIN}}$	$\overline{\text{KIN}}$	PULLUP*	$\overline{\text{KOUT}}$	NONE	YES	YES	YES
	Custom Button Mode. PFN1 is the active-low $\overline{\text{KIN}}$ button input. PFN2 is the open-drain $\overline{\text{KOUT}}$ output, which buffers the $\overline{\text{KIN}}$ input. The device can enter the off state by either a $\overline{\text{KIN}}$ press (>12s) or by writing to the PwrCmd register. A CHGIN insertion or a $\overline{\text{KIN}}$ press (>400ms) can exit the off state.						
CSR1	$\overline{\text{KIN}}$	PULLUP*	$\overline{\text{KOUT}}$	NONE	YES	NO	NO
	Custom Soft Reset 1. PFN1 is the active-low $\overline{\text{KIN}}$ button input. PFN2 is the open-drain $\overline{\text{KOUT}}$ output, which buffers the $\overline{\text{KIN}}$ input. A $\overline{\text{KIN}}$ press (>12s) generates a soft-reset. The device can only enter the off state through the PwrCmd register. A CHGIN insertion or a $\overline{\text{KIN}}$ press (>3s) can exit the off state.						
CSR2	$\overline{\text{KIN}}$	PULLUP*	Manual $\overline{\text{Reset}}$	NONE	YES	YES	YES
	Custom Soft-Reset 2. PFN1 is the active-low $\overline{\text{KIN}}$ button input. PFN2 is the active-low soft-reset input. A PFN2 press (>12s) generates a soft-reset. In this mode, the device can only enter the off state by writing to the PwrCmd register.						

* Pullup is connected to an internal supply, V_{CCINT}. (V_{CCINT} = V_{CAP} if V_{CAP} > V_{CCINT_TH}, or V_{CCINT} = V_{BAT} if V_{CAP} < V_{CCINT_TH}).

** PwrRstCfg[3:0] is read-only; the functions of PFN1 and PFN2 cannot be changed through I²C

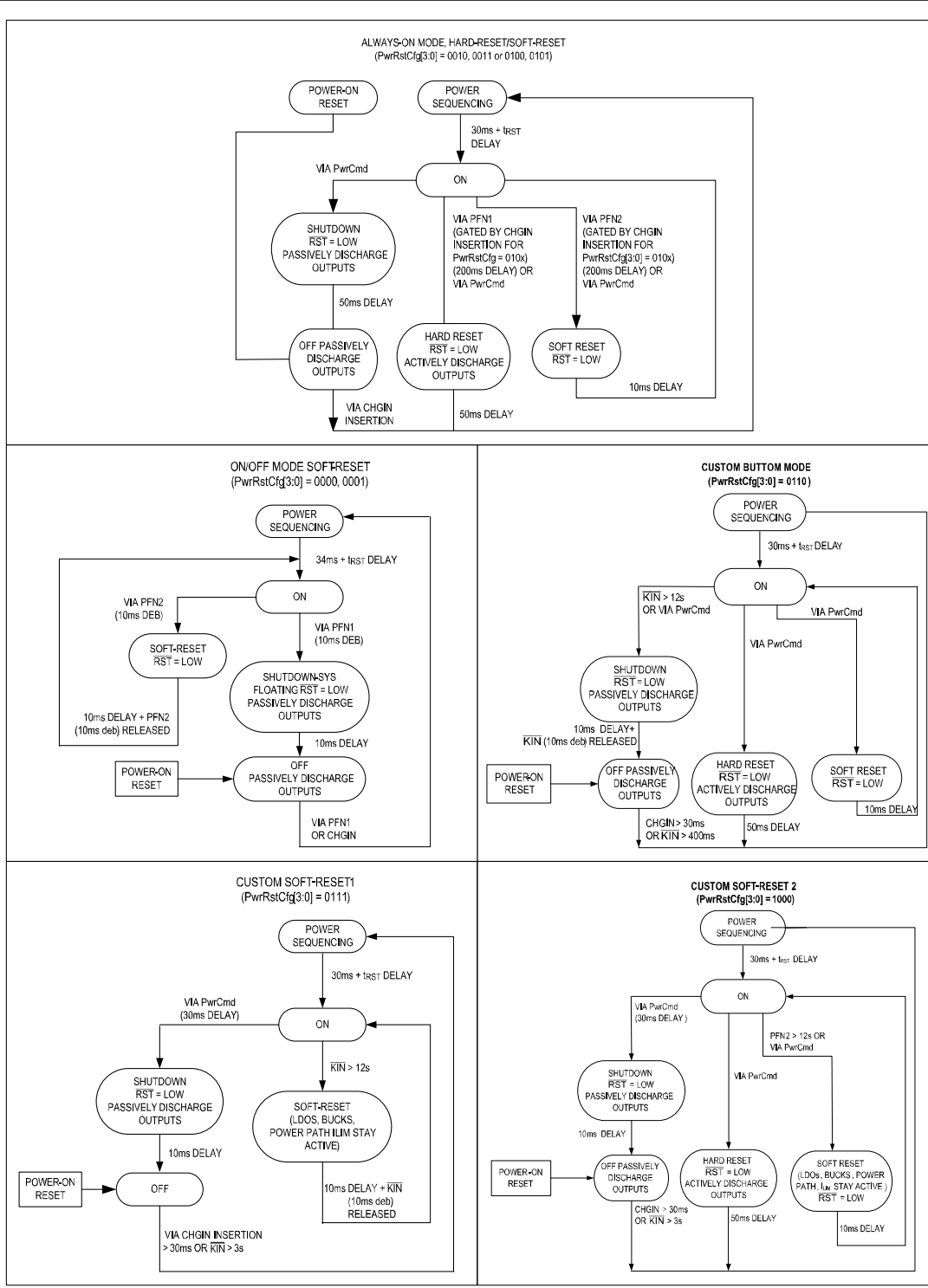

Figure 1. Power Function Input Control Modes Flow Diagrams

Power Sequencing

There are multiple configuration options for the sequencing of the buck regulators and LDOs during power-on. See [Table 1](#) for details. Regulators can be configured to turn on at one of the four points during the power-on process: 0% t_{RST}, 25% t_{RST}, 50% t_{RST}, and 100% t_{RST}. The reset delay t_{RST} can be set to 80ms, 120ms, 220ms, or 420ms by BootDly[1:0] in the BootCfg register. The power-on sequencing is depicted in [Figure 2a](#) and [Figure 2b](#).

Additionally, the regulators can be selected to default off and can be turned on with an I²C command after $\overline{\text{RST}}$ is released. Each LDO regulator can be configured to be always-on as long as SYS or BAT is present.

In general, if an undervoltage condition is detected on SYS the device goes into the off state. However if there is a valid voltage on CHGIN the behavior is determined by the ChgAlwTry setting. If ChgAlwTry = 0, and an undervoltage condition is detected on SYS during the sequencing process the device turns SYS and all other external resources off and waits for CHGIN removal. On CHGIN removal the device enters the off state to avoid draining the battery. If ChgAlwTry = 1, the process will continually recheck the SYS undervoltage condition every 500ms until it is no longer valid before continuing with the sequencing process.

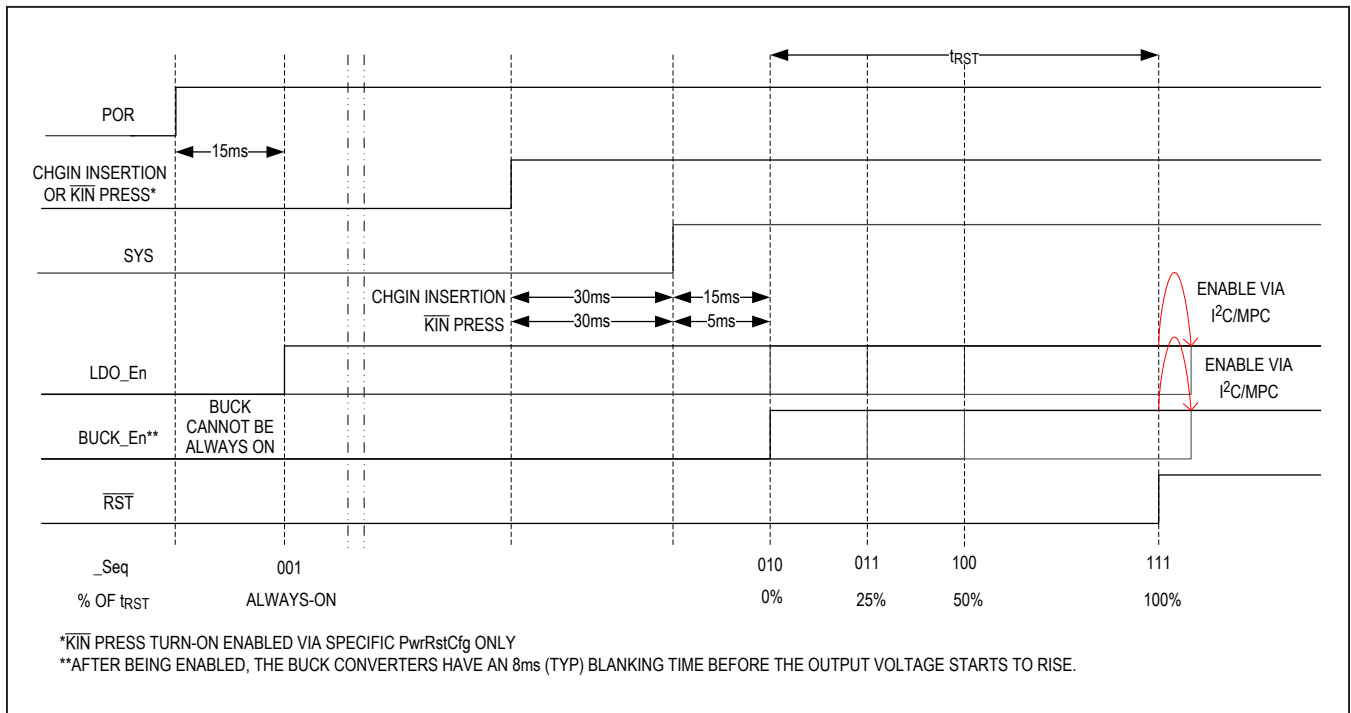

Figure 2a. Power-On Sequencing

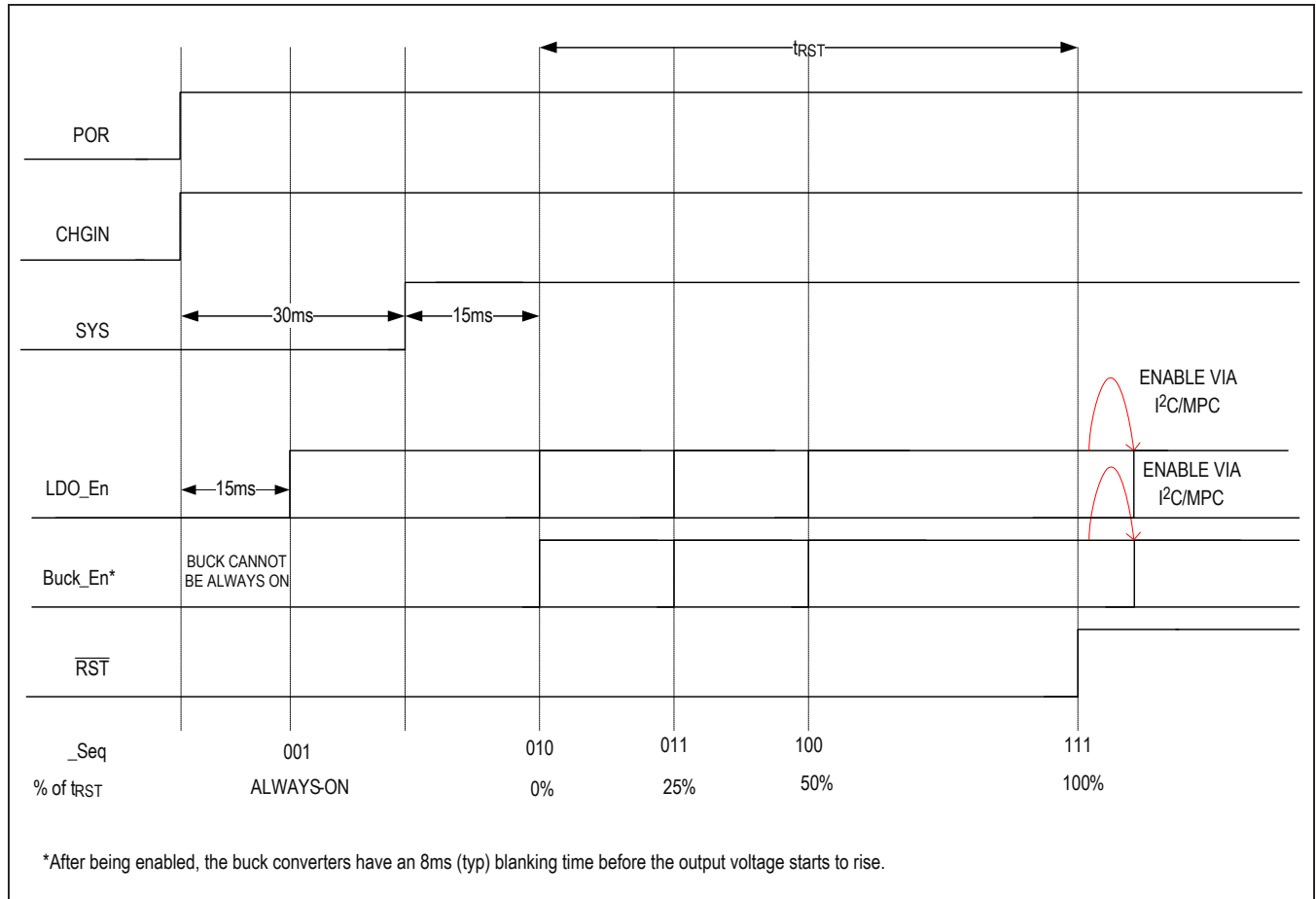

Figure 2b. Power-On Sequencing Without Battery

Smart Power Selector

The smart power selector seamlessly distributes power from the external CHGIN input to the battery (BAT) and the system (SYS). With both an external adapter and battery connected, the smart power selector basic functions are:

- When the system load requirements are less than the input current limit, the battery is charged with residual power from the input.
- When the system load requirements exceed the input current limit, the battery supplies supplemental current to the load.

- When the battery is connected and there is no external power input, the system is powered from the battery.

Thermal Current Regulation

In case the die temperature exceeds the normal limit, the MAX20335 will attempt to limit the temperature increase by reducing the input current from CHGIN. In this condition, the system load has priority over charger current, so the input current is first reduced by lowering the charge current. If the junction temperature continues to rise and reaches the maximum operating limit, no input current is drawn from CHGIN and the battery powers the entire system load.

System Load Switch

An internal 80mΩ (typ) MOSFET connects SYS to BAT when no voltage source is available on CHGIN. When an external source is detected at CHGIN, this switch opens and SYS is powered from the input source through the input current limiter. The SYS-to-BAT switch also prevents V_{SYS} from falling below V_{BAT} when the system load exceeds the input current limit. If V_{SYS} drops to V_{BAT} due to the current limit, the load switch turns on so the load is supported by the battery. If the system load continuously exceeds the input current limit the battery is not charged. This is useful for handling loads that are nominally below the input current limit but have high current peaks exceeding the input current limit. During these peaks, battery energy is used, but at all other times the battery charges. See [Figure 3](#).

The pin EXT can drive the gate of an external pMOS connected between SYS (source, bulk) and BAT (drain) in parallel to the internal one.

When V_{CHGIN} < V_{BDET} the EXT voltage is the buffered version of the internal gate command that controls the internal 80mΩ (typ) MOSFET.

Note: The body diode of an external pMOS connected between BAT and SYS remains present when the device is in off mode.

Input Limiter

The input limiter distributes power from the external adapter to the system load and battery charger. In addition to the input limiter’s primary function of passing power to the system load and charger, it performs several additional functions to optimize use of available power:

Invalid CHGIN Voltage Protection: If CHGIN is above the overvoltage threshold, the MAX20335 enters overvoltage lockout (OVL). OVL protects the MAX20335 and downstream circuitry from high-voltage stress up to 28V and down to -5.5V. During OVL, the internal circuit remains powered and an interrupt is sent to the host. During OVL, the charger turns off and the system load switch closes, allowing the battery to power SYS. CHGIN is also invalid if it is less than V_{BAT}, or less than the USB undervoltage threshold. With an invalid input voltage, the SYS-to-BAT load switch closes and allows the battery to power SYS.

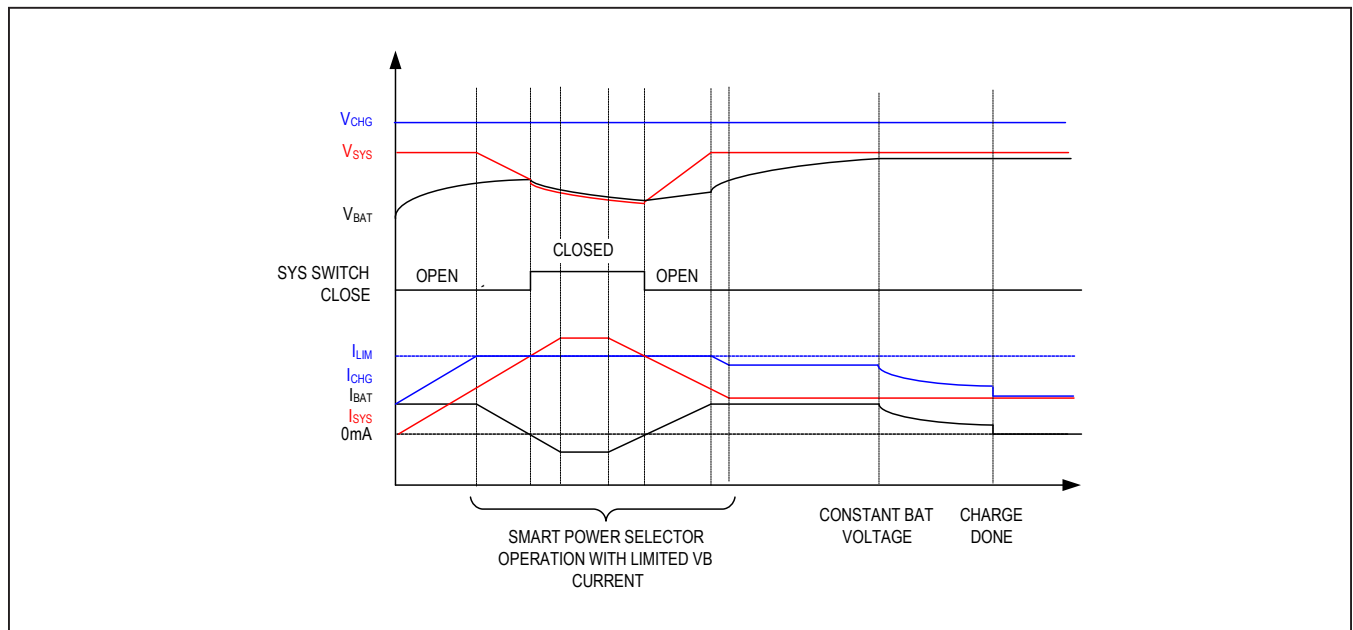

Figure 3. Smart Power Selector Current/Voltage Behavior

CHGIN Adaptive Input Current Limit: The CHGIN input current is limited to prevent input overload. The input current limit is controlled by I²C. However, if the voltage at CHGIN collapses because the source is not able to supply either the current programmed in I²C, or the total current required by the battery charger and system load, the input current limit will be adaptively reduced.

Thermal Limiting: In case the die temperature exceeds the normal limit (T_{CHG_LIM}), the MAX20335 attempts to limit temperature increase by reducing the input current from CHGIN. In this condition, the system load has priority over the charger current, so the input current is first reduced by lowering the charge current. If the junction temperature continues to rise and reaches the maximum operating limit (T_{CHGIN_SHDN}), no input current is drawn from CHGIN and the battery powers the entire system load.

Adaptive Battery Charging: While the system is powered from CHGIN, the charger draws power from SYS to charge the battery. If the total load exceeds the input current limit, an adaptive charger control loop reduces charge current to prevent V_{SYS} from collapsing.

When the charge current is reduced below 50% due to I_{LIM} or T_{DIE}, the timer clock operates at half speed. When the charge current is reduced below 20% due to I_{LIM} or T_{DIE}, the timer clock is paused.

Fast-Charge Current Setting

The MAX20335 uses an external resistor connected from SET to GND to set the fast-charge current. The pre-charge and charge-termination currents are programmed as a percentage of this value through I²C registers. The fast-charge current resistor can be calculated as:

$$R_{SET} = K_{SET} \times V_{SET} / I_{FChg}$$

where K_{SET} has a typical value of 2000A/A and V_{SET} has a typical value of 1V. The range of acceptable resistors for R_{SET} is 4kΩ to 400kΩ

Thermistor Monitoring with Charger Shutdown

The MAX20335 features three modes for controlling charger behavior based on battery-pack temperature: Thermistor Monitoring, JEITA Monitoring 1, and JEITA Monitoring 2. The divider formed by a pull-up resistor (RPU) to CAP, optional parallel resistor (RPA) from THM to ground, and NTC thermistor (RTHM) from THM to ground, provides a voltage at THM that is proportional to temperature as a fraction of the CAP voltage. Two sets of preconfigured default thresholds (0°C/10°C/45°C/60°C or 0°C/10°C/25°C/45°C as a %CAP) optimized for beta 3380 thermistors are available (see [Table 38](#)). The four default thresholds create five temperature zones, and the fractional CAP voltage measured at the THM pin is compared to the thresholds to determine the active temperature zone during operation.

The behavior in each temperature zone is determined by the configuration of bits in the I²C registers. The active monitoring mode is selected by ThermEn[1:0] in the ThrmCfrg register. In all modes, the T2IFchg[2:0] and T2T3IFchg[2:0], and T3T4IFchg[2:0] fields in the ThrmCfrg registers set the fast charge current in three temperature zones, T1_T2, T2_T3, and T3_T4. In Thermistor Monitoring mode, charging is enabled only in T1_T2 and T2_T3 and the battery termination voltage is equal to V_{BATREG}, as shown in [Figure 4a](#). In both JEITA Monitoring 1 and JEITA Monitoring 2 the charger is active in the T1_T2, T2_T3, and T3_T4 zones. However, JEITA Monitoring 1 sets the battery termination voltage to V_{BATREG} for all zones, while JEITA Monitoring 2 sets the battery termination voltage to V_{BATREG} - 150mV for zones T1_2 and T3_T4, as shown in [Figure 4b](#). The behavior of all three modes is summarized in [Table 2](#).

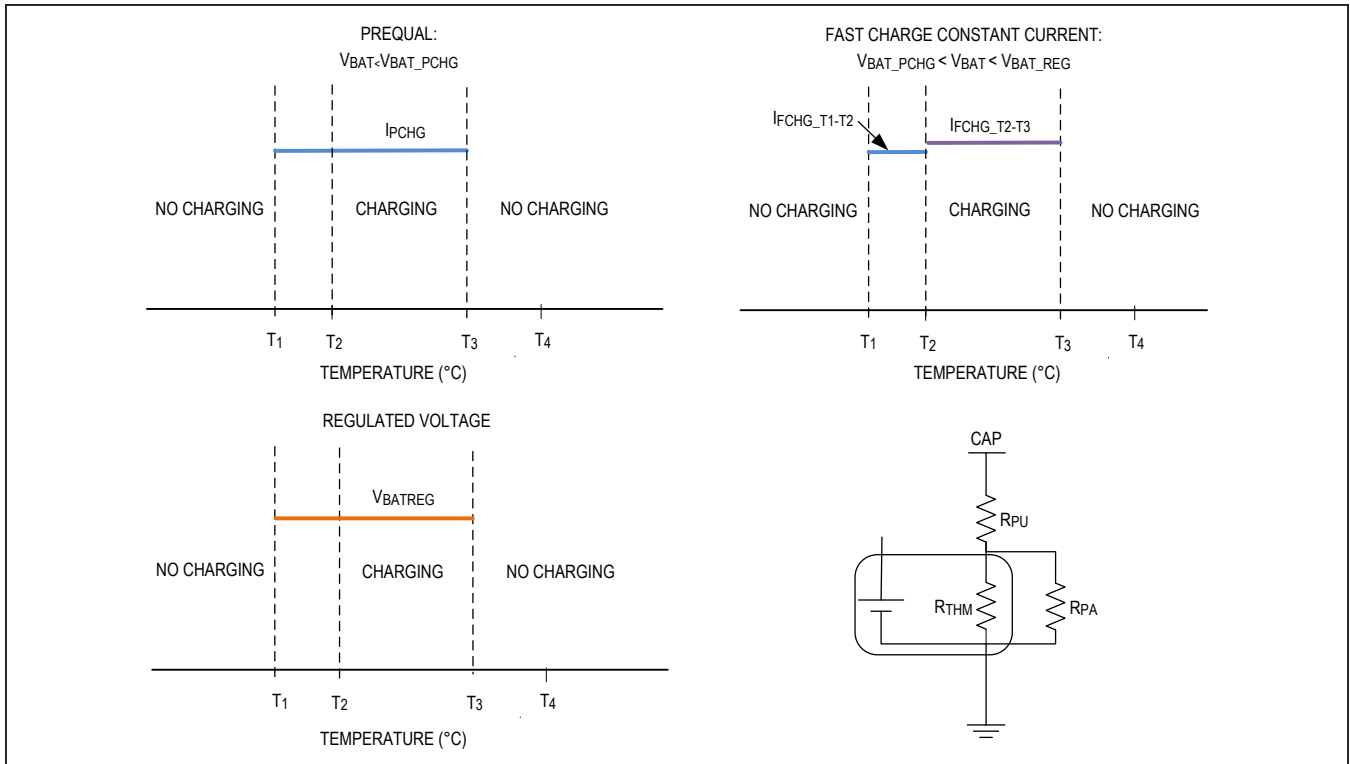

Figure 4a. Charging Behavior Using Thermistor Monitoring Mode

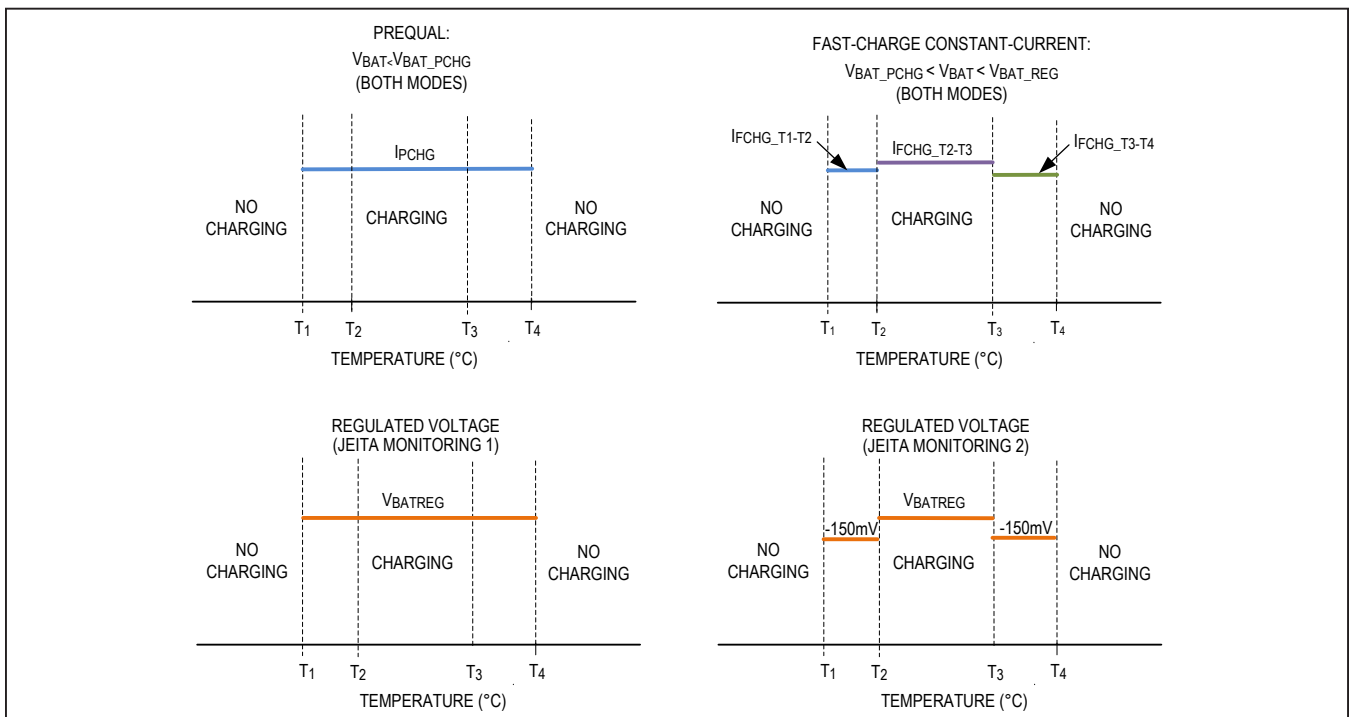

Figure 4b. Charging Behavior Using JEITA Monitoring 1 and 2 Modes

Table 2. Thermistor Monitoring/JEITA Monitoring Enable Control

ThermEn[1:0]	DESCRIPTION	CHARGER MODE				
		T < T1	T1 < T < T2	T2 < T < T3	T3 < T < T4	T > T4
00	Thermistor/ JEITA Monitoring OFF	As per I ² C settings				
01	Thermistor Monitoring ON	OFF	I _{PCHG} = IPChg, I _{FChg} = T1T2IFchg, Regulated Voltage = V _{BATREG}	I _{PCHG} = IPChg, I _{FChg} = T2T3IFchg, Regulated Voltage = V _{BATREG}	OFF	OFF
10	JEITA Monitoring 1 ON	OFF	I _{PCHG} = IPChg, I _{FChg} = T1T2IFchg, Regulated Voltage = V _{BATREG}	I _{PCHG} = IPChg, I _{FChg} = T2T3IFchg Regulated Voltage = V _{BATREG}	I _{PCHG} = IPChg, I _{FChg} = T3T4IFchg Regulated Voltage = V _{BATREG}	OFF
11	JEITA Monitoring 2 ON	OFF	I _{PCHG} = IPChg, I _{FChg} = T1T2IFchg, Regulated Voltage = V _{BATREG} - 150mV	I _{PCHG} = IPChg, I _{FChg} = T2T3IFchg, Regulated Voltage = V _{BATREG}	I _{PCHG} = IPChg, I _{FChg} = T3T4IFchg, Regulated Voltage = V _{BATREG} - 150mV	OFF

I²C Interface

The device uses the two-wire I²C interface to communicate with the host microcontroller. The configuration settings and status information provided through this interface are detailed in the register descriptions.

I²C Addresses

The registers of the MAX20335 are accessed through the slave address of 0101000 (0x50 for writes/0x51 for reads).

Thermistor Monitoring with Charger Shutdown

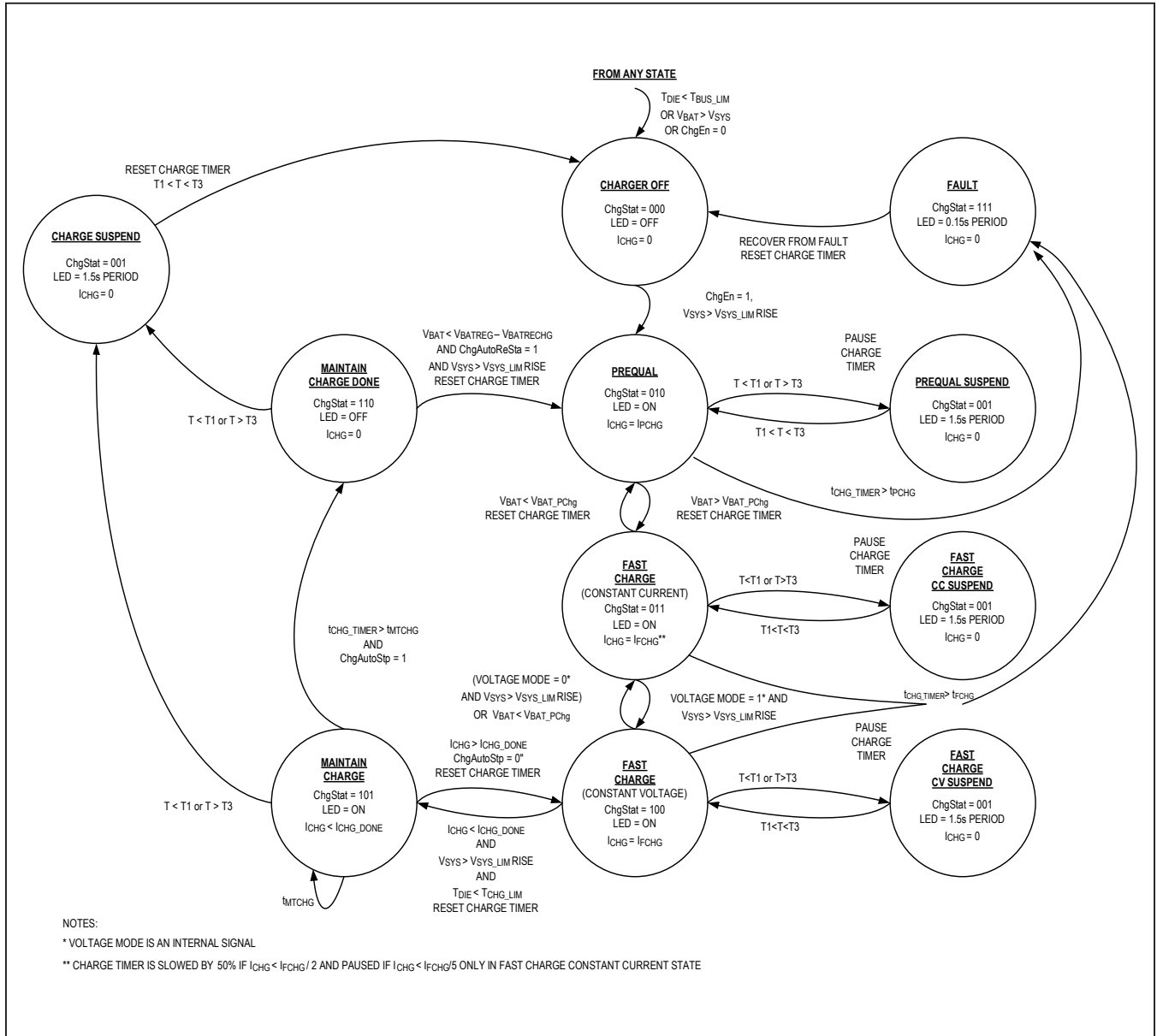

Figure 5a. Charger State Diagram (Thermistor Monitoring with Charger Shutdown)

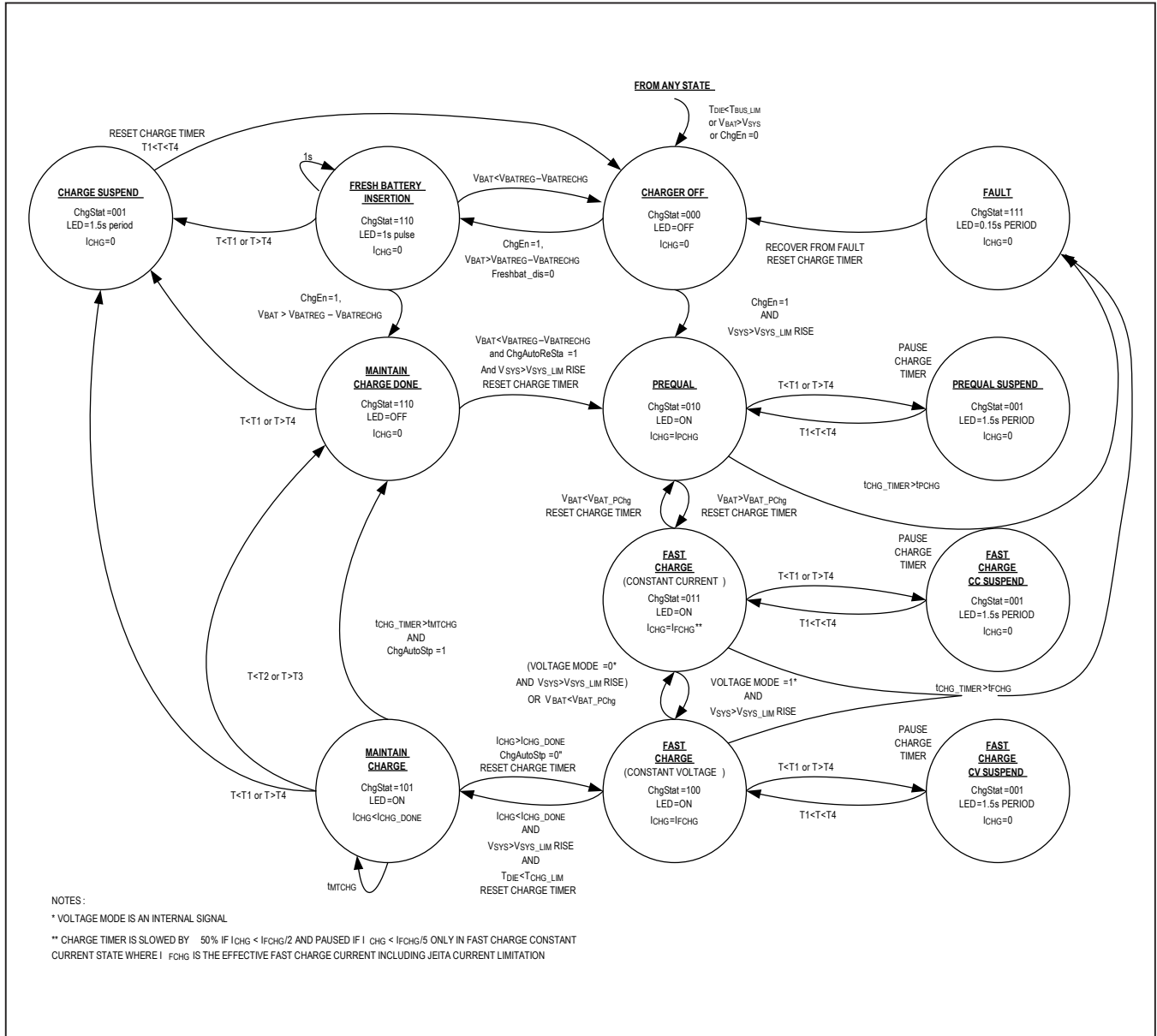

Figure 5b. Battery Charger State Diagram (JEITA Monitoring with Charger Shutdown)

I²C Interface

The MAX20335 contain an I²C-compatible interface for data communication with a host controller (SCL and SDA). The interface supports a clock frequency of up to 400kHz. SCL and SDA require pullup resistors that are connected to a positive supply.

Start, Stop, And Repeated Start Conditions

When writing to the MAX20335 using I²C, the master sends a START condition (S) followed by the MAX20335 I²C address. After the address, the master sends the register address of the register that is to be programmed. The master then ends communication by issuing a STOP condition (P) to relinquish control of the bus, or a REPEATED START condition (Sr) to communicate to another I²C slave. See [Figure 6](#).

Table 3. I²C Slave Addresses

ADDRESS FORMAT	HEX	BINARY
7-Bit Slave ID	0x28	0101000
Write Address	0x50	01010000
Read Address	0x51	01010001

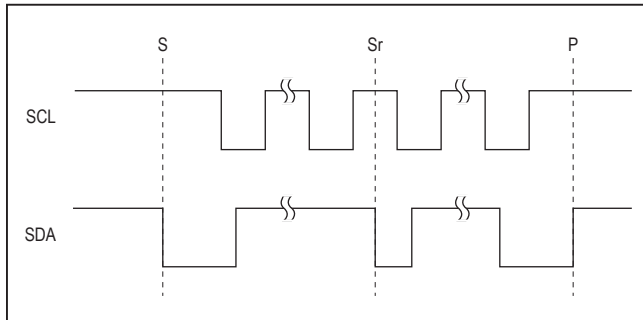

Figure 6. I²C START, STOP and REPEATED START Conditions

Slave Address

Set the Read/Write bit high to configure the MAX20335 to read mode ([Table 3](#)). Set the Read/Write bit low to configure the MAX20335 to write mode. The address is the first byte of information sent to the MAX20335 after the START condition.

Bit Transfer

One data bit is transferred on the rising edge of each SCL clock cycle. The data on SDA must remain stable during the high period of the SCL clock pulse. Changes in SDA while SCL is high and stable are considered control signals (see the [Start, Stop, And Repeated Start Conditions](#) section). Both SDA and SCL remain high when the bus is not active.

Single-Byte Write

In this operation, the master sends an address and two data bytes to the slave device ([Figure 7](#)). The following procedure describes the single byte write operation:

- 1) The master sends a START condition
- 2) The master sends the 7-bit slave address plus a write bit (low)
- 3) The addressed slave asserts an ACK on the data line
- 4) The master sends the 8-bit register address
- 5) The slave asserts an ACK on the data line only if the address is valid (NAK if not)
- 6) The master sends 8 data bits
- 7) The slave asserts an ACK on the data line
- 8) The master generates a STOP condition

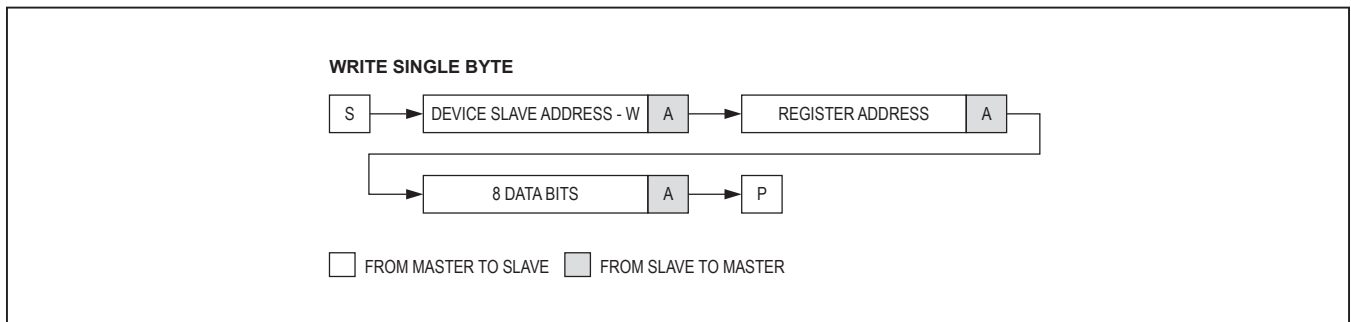

Figure 7. Write Byte Sequence

Burst Write

In this operation, the master sends an address and multiple data bytes to the slave device (Figure 8). The slave device automatically increments the register address after each data byte is sent. The following procedure describes the burst write operation:

- 1) The master sends a START condition
- 2) The master sends the 7-bit slave address plus a write bit (low)
- 3) The addressed slave asserts an ACK on the data line
- 4) The master sends the 8-bit register address
- 5) The slave asserts an ACK on the data line only if the address is valid (NAK if not)
- 6) The master sends eight data bits
- 7) The slave asserts an ACK on the data line
- 8) Repeat 6 and 7 N-1 times
- 9) The master generates a STOP condition

Single Byte Read

In this operation, the master sends an address plus two data bytes and receives one data byte from the slave device (Figure 9). The following procedure describes the single byte read operation:

- 1) The master sends a START condition
- 2) The master sends the 7-bit slave address plus a write bit (low)
- 3) The addressed slave asserts an ACK on the data line
- 4) The master sends the 8-bit register address
- 5) The slave asserts an ACK on the data line only if the address is valid (NAK if not)
- 6) The master sends a REPEATED START condition
- 7) The master sends the 7-bit slave address plus a read bit (high)
- 8) The addressed slave asserts an ACK on the data line
- 9) The slave sends eight data bits
- 10) The master asserts a NACK on the data line
- 11) The master generates a STOP condition

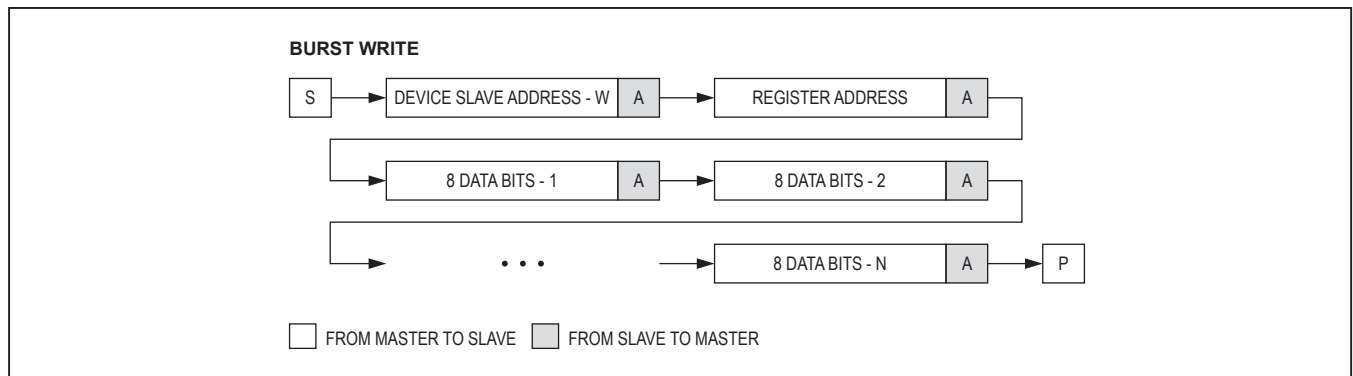

Figure 8. Burst Write Sequence

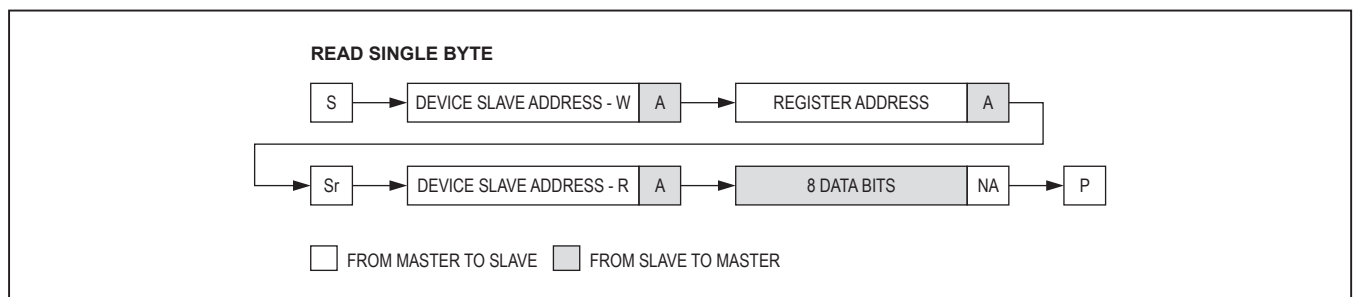

Figure 9. Read Byte Sequence

Burst Read

In this operation, the master sends an address plus two data bytes and receives multiple data bytes from the slave device (Figure 10). The following procedure describes the burst byte read operation:

- 1) The master sends a START condition
- 2) The master sends the 7-bit slave address plus a write bit (low)
- 3) The addressed slave asserts an ACK on the data line
- 4) The master sends the 8-bit register address
- 5) The slave asserts an ACK on the data line only if the address is valid (NAK if not)
- 6) The master sends a REPEATED START condition
- 7) The master sends the 7-bit slave address plus a read bit (high)
- 8) The slave asserts an ACK on the data line
- 9) The slave sends eight data bits
- 10) The master asserts an ACK on the data line
- 11) Repeat 9 and 10 N-2 times
- 12) The slave sends the last eight data bits
- 13) The master asserts a NACK on the data line
- 14) The master generates a STOP condition

Acknowledge Bits

Data transfers are acknowledged with an acknowledge bit (ACK) or a not-acknowledge bit (NACK). Both the master and the MAX20335 generate ACK bits. To generate an ACK, pull SDA low before the rising edge of the ninth clock pulse and hold it low during the high period of the ninth clock pulse (see Figure 11). To generate a NACK, leave SDA high before the rising edge of the ninth clock pulse and leave it high for the duration of the ninth clock pulse. Monitoring for NACK bits allows for detection of unsuccessful data transfers.

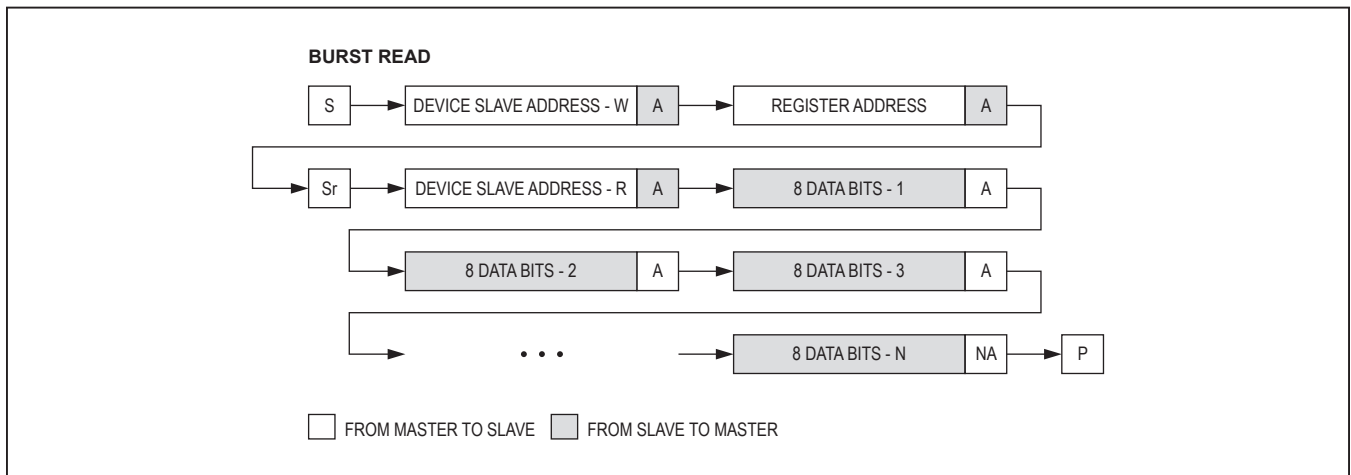

Figure 10. Burst Read Sequence

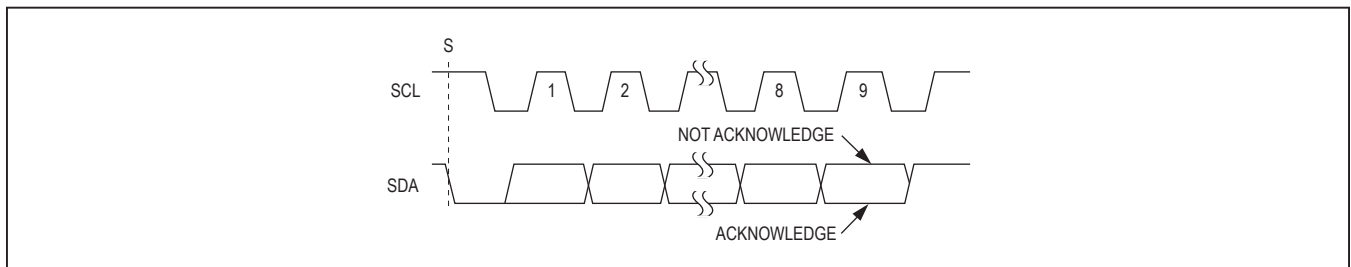

Figure 11. Acknowledge

I²C Register Map

REGISTER ADDRESS	REGISTER NAME	R/W	B7	B6	B5	B4	B3	B2	B1	B0
0x00	ChipId	R								
0x01	ChipRev	R								
0x02	StatusA	R								
0x03	StatusB	R	UVLOLDO2	UVLOLDO3	ILim	UsbOVP	UsbOk	ThrmSd	ChgStat[2:0]	ChgTmo
0x04	StatusC	R		SysBatLim	ChgSysLim	ThrmBk1	ThrmBk2	ThrmLDO1	ThrmLDO2	ThrmLDO3
0x05	IntA	COR	ThermStatInt	ChgStatInt	ILimInt	UsbOVPInt	UsbOkInt	ChgThrmSdInt	ChgThrmRegInt	ChgTmolnt
0x06	IntB	COR		SysBatLimInt	ChgSysLimInt	ThrmBk1Int	ThrmBk2Int	ThrmLDO1Int	ThrmLDO2Int	ThrmLDO3Int
0x07	IntMaskA	R/W	ThermStatIntM	ChgStatIntM	ILimIntM	UsbOVPIntM	UsbOkIntM	ChgThrmSdIntM	ChgThrmRegIntM	ChgTmolntM
0x08	IntMaskB	R/W		SysBatLimIntM	ChgSysLimIntM	ThrmBk1IntM	ThrmBk2IntM	ThrmLDO1IntM	ThrmLDO2IntM	ThrmLDO3IntM
0x09*	ILimCntl	R/W**	SysMin[2:0]	SysMin[2:0]	SysMin[2:0]				ILimCntl[1:0]	
0x0A*	ChgCntlA	R/W**		BatReChg[1:0]			BatReg[3:0]			ChgEn
0x0B*	ChgCntlB	R/W**		VPCchg[2:0]			IPCchg[1:0]		ChgDone[1:0]	
0x0C*	ChTmr	R/W**	ChgAutoStp	ChgAutoReSta	MtChgTmr[1:0]		FChgTmr[1:0]		PChgTmr[1:0]	
0x0D	Buck1Cfg	R/W		Buck1Seq[2:0]		Buck1En[1:0]	Buck1PFWDIs		Reserved	
0x0E	Buck1VSet	R/W**	Buck1LowEMI				Buck1VSet[5:0]			
0x0F	Buck2Cfg	R/W		Buck2Seq[2:0]		Buck2En[1:0]	Buck2PFWDIs		Reserved	
0x10	Buck2VSet	R/W**	Buck2LowEMI				Buck2VSet[5:0]			
0x11	Buck1/2ISet	R/W		Buck2ISet[3:0]			Buck1SSet[3:0]			
0x12	LDO1Cfg	R/W	LDO1Seq[2:0]				LDO1ActDSC	LDO1En[1:0]		LDO1Mode

I²C Register Map (continued)

REGISTER ADDRESS	REGISTER NAME	R/W	B7	B6	B5	B4	B3	B2	B1	B0	
0x13	LDO1VSet	R/W**	—	—	—	—	—	LDO1VSet[4:0]			
0x14	LDO2Cfgr	R/W	—	LDO2Seq[2:0]	—	—	LDO2 ActDSC	LDO2En[1:0]	—	LDO2Mode	
0x15	LDO2VSet	R/W**	—	—	—	—	—	LDO2VSet[4:0]			
0x16	LDO3Cfgr	R/W	—	LDO3Seq[2:0]	—	—	LDO3 ActDSC	LDO3En[1:0]	—	LDO3Mode	
0x17	LDO3VSet	R/W**	—	—	—	—	—	LDO3VSet[4:0]			
0x18*	ThrmCfgr	R/W	—	T1T2Fchg[2:0]	—	—	T2T3Fchg[2:0]	ThermEn[1:0]	—	—	
0x19*	ThrmCfgr	R/W	—	—	—	—	—	T3T4Fchg[2:0]	—	—	
0x1A	MONCfgr	R/W	—	—	MONRatioCfgr[1:0]	—	MONHiZ	MONCtr[2:0]	—	—	
0x1B	BootCfgr	R/W	—	—	PwrRstCfgr[3:0]	—	SftRstCfgr	BootDly[1:0]	—	ChgAlwTry	
0x1C	PinStat	R/W	—	ILim_T[2:0]	—	—	PFN1	PFN2	MPC1	MPC0	
0x1D	Buck1/2Extra	R/W	Buck2AdptEnb	Buck2Fst	Buck2 ActDsc	Buck2FFET	Buck1AdptEnb	Buck1Fst	Buck1ActDSC	Buck1FFET	
0x1E	PwrCfgr	R/W	PFNxResEna	—	—	—	—	—	—	StayOn	
0x1F	PwrCmd	R/W	PWR_CMD							—	—

Note: COR = Clear-on-read

*Register is reset to default value upon CHGIN rising edge.

** R if WriteProtect enabled (Table 38).

All R/W registers are reset to default value when entering the off state.

Reserved bits must not be modified from their default states to ensure proper operation.

I²C Register Descriptions

Table 4. ChipId Register (0x00)

ADDRESS:	0x00							
MODE:	Read-Only							
BIT	7	6	5	4	3	2	1	0
NAME	Chip_Id[7:0]							
Chip_Id[7:0]	Chip_Id[7:0] bits show information about the version of the MAX20335.							

Table 5. ChipRev Register (0x01)

ADDRESS:	0x01							
MODE:	Read-Only							
BIT	7	6	5	4	3	2	1	0
NAME	Chip_Rev[7:0]							
Chip_Rev[7:0]	Chip_Rev[7:0] bits show information about the revision of the MAX20335 silicon.							

Table 6. StatusA Register (0x02)

ADDRESS:	0x02							
MODE:	Read-Only							
BIT	7	6	5	4	3	2	1	0
NAME	—	—	ThermStat[2:0]			ChgStat[2:0]		
ThermStat[2:0]	<p>Status of Thermistor Monitoring</p> <p>000 = T < T1</p> <p>001 = T1 < T < T2</p> <p>010 = T2 < T < T3</p> <p>011 = T3 < T < T4</p> <p>100 = T > T4</p> <p>101 = No thermistor detected (THM high due to external pullup). Note that if a parallel resistor is used for thermistor monitoring, this mode may not function properly.</p> <p>110 = NTC input disabled through ThermEn[1:0]</p> <p>111 = Detection disabled due to CHGIN not present.</p>							
ChgStat[2:0]	<p>Status of Charger Mode</p> <p>000 = Charger off</p> <p>001 = Charging suspended due to temperature (see Figure 5a and Figure 5b)</p> <p>010 = Pre-charge in progress</p> <p>011, 100 = Fast charge in progress</p> <p>101 = Maintain charge in progress</p> <p>110 = Maintain charger timer done</p> <p>111 = Charger fault condition (see Figure 5a and Figure 5b)</p>							

Table 7. StatusB Register (0x03)

ADDRESS:	0x03							
MODE:	Read-Only							
BIT	7	6	5	4	3	2	1	0
NAME	UVLOLDO2	UVLOLDO3	ILim	UsbOVP	UsbOk	Chg ThrmSd	Chg ThrmReg	ChgTmo
UVLOLDO2	Status of LDO2 UVLO 0 = LDO2 in normal operating mode 1 = Undervoltage-lockout on LDO2							
UVLOLDO3	Status of LDO3 UVLO 0 = LDO3 in normal operating mode 1 = Undervoltage-lockout on LDO3							
ILim	CHGIN Input Current Limit 0 = CHGIN input current is within limit. 1 = CHGIN input is in current limit.							
UsbOVP	Status of CHGIN OVP 0 = CHGIN OVP is not active. 1 = CHGIN OVP is active.							
UsbOk	Status of CHGIN Input 0 = CHGIN Input is not present or outside of valid range. 1 = CHGIN Input is present and valid.							
ChgThrmSd	Status of Thermal Shutdown 0 = Charger and input current limiter is in normal operating mode. 1 = Charger and input current limiter is in thermal shutdown.							
ChgThrmReg	Status of Thermal Regulation 0 = Charger is functioning normally, or disabled. 1 = Charger is running in thermal regulation mode and charging current is being actively reduced to prevent device overheating.							
ChgTmo	Status of Time-Out Condition 0 = Charger is running normally, or disabled. 1 = Charger has reached a time-out condition. ChgStat =1 11 in this condition (see Figure 5).							

Table 8. StatusC Register (0x04)

ADDRESS:	0x04							
MODE:	Read-Only							
BIT	7	6	5	4	3	2	1	0
NAME	—	SysBLim	VLim	ThrmBuck1	ThrmBuck2	ThrmLDO1	ThrmLDO2	ThrmLDO3
SysBLim	<p>Status of Minimum SYS-BAT Voltage Limit. While the system is powered from VBUS, the charger draws power from SYS to charge the battery. If the total load exceeds the input current limit, an adaptive charger control loop reduces charge current to prevent V_{SYS} from collapsing. The regulation of the charge current starts when either one of the following two conditions is true: 1. V_{SYS} - V_{BAT} = 100mV (typ) OR 2. V_{SYS} = V_{SYS_LIM} (falling)</p> <p>0 = Charge Current is normal. 1 = Charge Current is being actively reduced to prevent SYS collapse.</p>							
VLim	<p>Status of CHGIN-SYS Voltage Limit. This bit indicates if the input current limit is being actively reduced to maintain a 40mV drop between CHGIN-SYS. This adaptive input current limit prevents adapter collapse in the case that a power adapter with insufficient load capability, or a high resistance charging cable is used.</p> <p>0 = CHGIN input current limit is functioning normally. 1 = CHGIN input current limit is being actively reduced to maintain 40mV drop between CHGIN-SYS.</p>							
ThrmBuck1	<p>0 = Buck1 NOT in Thermal Off mode 1 = Buck1 in Thermal Off Mode</p>							
ThrmBuck2	<p>0 = Buck2 NOT in Thermal Off mode 1 = Buck2 in Thermal Off Mode</p>							
ThrmLDO1	<p>0 = LDO1 NOT in Thermal Off mode 1 = LDO1 in Thermal Off Mode</p>							
ThrmLDO2	<p>0 = LDO2 NOT in Thermal Off mode 1 = LDO2 in Thermal Off Mode</p>							
ThrmLDO3	<p>0 = LDO3 NOT in Thermal Off mode 1 = LDO3 in Thermal Off Mode</p>							

Table 9. IntA Register (0x05)

ADDRESS:	0x05							
MODE:	Clear On Read							
BIT	7	6	5	4	3	2	1	0
NAME	Therm StatInt	ChgStatInt	ILimInt	UsbOVPInt	UsbOk	Chg ThrmSdInt	Therm RegInt	Chg Tmolnt
ThermStatInt	Change in ThermStat caused interrupt.							
ChgStatInt	Change in ChgStat caused interrupt, or first detection complete after POR.							
ILimInt	Input current limit triggered caused interrupt.							
UsbOVPInt	Change in UsbOVP caused interrupt.							
UsbOk	Change in UsbOk caused interrupt.							
ChgThrmSdInt	Change in ChgThrmSd caused interrupt.							
ThermRegInt	Change in ChgThrmReg caused interrupt.							
ChgTmolnt	Change in ChgTmo caused interrupt.							

Table 10. IntB Register (0x06)

ADDRESS:	0x06							
MODE:	Clear On Read							
BIT	7	6	5	4	3	2	1	0
NAME	—	SysBLimInt	VLimInt	Thrm Buck1Int	Thrm Buck2Int	Thrm LDO1Int	Thrm LDO2Int	Thrm LDO3Int
SysBLimInt	Minimum SYS-BAT voltage limit caused interrupt							
VLimInt	Input Voltage Limit caused interrupt							
ThrmBuck1Int	Change in ThrmBuck1 caused interrupt.							
ThrmBuck2Int	Change in ThrmBuck2 caused interrupt.							
ThrmLDO1Int	Change in ThrmLDO1 caused interrupt.							
ThrmLDO2Int	Change in ThrmLDO2 caused interrupt.							
ThrmLDO3Int	Change in ThrmLDO3 caused interrupt.							

Table 11. IntMaskA Register (0x07)

ADDRESS:	0x07							
MODE:	Read/Write							
BIT	7	6	5	4	3	2	1	0
NAME	Therm StatIntM	Chg StatIntM	ILimIntM	Usb OVPIntM	UsbOkM	ChgThrm SdIntM	Therm RegIntM	Chg TmolntM
ThermStatIntM	ThermStatIntM masks the ThermStatInt interrupt in the IntA register (0x05). 0 = Mask 1 = Not masked							
ChgStatIntM	ChgStatIntM masks the ChgStatInt interrupt in the IntA register (0x05). 0 = Mask 1 = Not masked							
ILimIntM	ILimIntM masks the ILimInt interrupt in the IntB register (0x06). 0 = Mask 1 = Not masked							
UsbOVPIntM	UsbOVPIntM masks the UsbOVPInt interrupt in the IntA register (0x05). 0 = Mask 1 = Not masked							
UsbOkM	UsbOkM masks the UsbOk interrupt in the IntB register (0x06). 0 = Mask 1 = Not masked							
ChgThrm SdIntM	ChgThrmSdIntM masks the ChgThrmSdInt interrupt in the IntB register (0x06). 0 = Mask 1 = Not masked							
ThermRegIntM	ThermRegIntM masks the ThermRegInt interrupt in the IntA register (0x05). 0 = Mask 1 = Not masked							
ChgTmolntM	ChgTmolntM masks the ChgTmolnt interrupt in the IntA register (0x05). 0 = Mask 1 = Not masked							

Table 12. IntMaskB Register (0x08)

ADDRESS:	0x08							
MODE:	Read/Write							
BIT	7	6	5	4	3	2	1	0
NAME	—	SysB LimIntM	VLimIntM	Thrm Buck1IntM	Thrm Buck2IntM	Thrm LDO1IntM	Thrm LDO2IntM	Thrm LDO3IntM
SysBLimIntM	SysBLimIntM masks the SysBLimInt interrupt in the IntB register (0x06). 0 = Mask 1 = Not masked							
VLimIntM	VLimIntM masks the VLimInt interrupt in the IntB register (0x06). 0 = Mask 1 = Not masked							
ThrmBuck1 IntM	0 = Mask 1 = Not masked							
ThrmBuck2 IntM	0 = Mask 1 = Not masked							
ThrmLDO1 IntM	0 = Mask 1 = Not masked							
ThrmLDO2 IntM	0 = Mask 1 = Not masked							
ThrmLDO3 IntM	0 = Mask 1 = Not masked							

Table 13. ILimCntl Register (0x09)

ADDRESS:	0x09								
MODE:	Read/Write* or Read-Only if Write-Protect Enabled (see Table 38)								
BIT	7	6	5	4	3	2	1	0	
NAME	SysMin[2:0]				—	—	—	ILimCntl [1:0]	
SysMin[2:0]	SysMin sets System Voltage Minimum Threshold. When SYS drops to this level, the charger current is reduced. 000 = 3.6V 001 = 3.7V 010 = 3.8V 011 = 3.9V 100 = 4.0V 101 = 4.1V 110 = 4.2V 111 = 4.3V								
ILimCntl[1:0]	CHGIN Custom Input Current Limit (see Electrical Characteristics table for details) 00 = 0mA 01 = 100mA 10 = 500mA 11 = 1000mA								

*Register is reset to default value upon CHGIN rising edge.

Table 14. ChgCntlA Register (0x0A)

ADDRESS:	0x0A							
MODE:	Read/Write* or Ready-Only if Write-Protect Enabled (see Table 38)							
BIT	7	6	5	4	3	2	1	0
NAME	BatReChg[1:0]			BatReg[3:0]				ChgEn
BatReChg[1:0]	Recharge Threshold in Relation to BatReg 00 = BatReg - 70mV 01 = BatReg - 120mV 10 = BatReg - 170mV 11 = BatReg - 220mV							
BatReg[3:0]	Setting the Battery Regulation Threshold 0000 = 4.05V 0001 = 4.10V 0010 = 4.15V 0011 = 4.20V 0100 = 4.25V 0101 = 4.30V 0110 = 4.35V 0111 = 4.4V 1000 = 4.45V 1001 = 4.5V 1010 = 4.55V 1011 = 4.6V 1100...1111 = Reserved							
ChgEn	On/Off Control for Charger (does not affect SYS node). 0 = Charger disabled. 1 = Charger enabled.							

*Register is reset to default value upon CHGIN rising edge.

Table 15. ChgCntlB Register (0x0B)

ADDRESS:	0x0B							
MODE:	Read/Write* or Ready-Only if Write-Protect Enabled (see Table 38)							
BIT	7	6	5	4	3	2	1	0
NAME	-	VPChg[2:0]			IPChg[1:0]		ChgDone[1:0]	
VPChg[2:0]	Pre-charge voltage threshold setting 000 = 2.10V 001 = 2.25V 010 = 2.40V 111 = 2.55V 100 = 2.70V 101 = 2.85V 110 = 3.00V 111 = 3.15V							
IPChg[1:0]	Pre-charge current setting 00 = 0.05 x I _{FChg} 01 = 0.1 x I _{FChg} 10 = 0.2 x I _{FChg} 11 = 0.3 x I _{FChg}							
ChgDone[1:0]	Charge Done Threshold Setting 00 = 0.05 x I _{FChg} 01 = 0.1 x I _{FChg} 10 = 0.2 x I _{FChg} 11 = 0.3 x I _{FChg}							

*Register is reset to default value upon CHGIN rising edge.

Table 16. ChTmr Register (0x0C)

ADDRESS:	0x0C							
MODE:	Read/Write* or Ready-Only if Write-Protect Enabled (see Table 38)							
BIT	7	6	5	4	3	2	1	0
NAME	ChgAutoStp	ChpAutoReSta	MtChgTmr[1:0]		FChgTmr[1:0]		PChgTmr[1:0]	
ChgAutoStp	Charger Auto-Stop. Controls the transition from Maintain Charger to Maintain Charger Done. 0 = Auto-stop disabled. 1 = Auto-stop enabled.							
ChgAutoReSta	Charger Auto-Restart Control 0 = Charger remains in maintain charge done even when VBAT is less than charge restart threshold (see Charger state diagram) 1 = Charger automatically restarts when VBAT drops below charge restart threshold							
MtChgTmr [1:0]	Maintain Charge Timer Setting 00 = 0min 01 = 15min 10 = 30min 11 = 60min							
FChgTmr[1:0]	Fast-Charge Timer Setting 00 = 75min 01 = 150min 10 = 300min 11 = 600min							
PChgTmr[1:0]	Precharge Timer Setting 00 = 30min 01 = 60min 10 = 120min 11 = 240min							

*Register is reset to default value upon CHGIN rising edge.

Table 17. Buck1Cfg Register (0x0D)

ADDRESS:	0x0D							
MODE:	Read/Write							
BIT	7	6	5	4	3	2	1	0
NAME	Buck1Seq[2:0] (Read-only)			Buck1En[1:0]		Buck1PFWDIs	Reserved	
Buck1Seq[2:0]	Buck1 Enable Configuration (Read-Only) 000 = Disabled 001 = Reserved 010 = Enabled at 0% of Boot/POR Process Delay Control 011 = Enabled at 25% of Boot/POR Process Delay Control 100 = Enabled at 50% of Boot/POR Process Delay Control 101 = Reserved 110 = Reserved 111 = Controlled by Buck1En[1:0] after 100% of Boot/POR Process Delay Control							
Buck1En[1:0]	Buck1 Enable Configuration (effective only when Buck1Seq = 111) 00 = Disabled (Buck1 OUT not actively discharged unless in Hard Reset/ShutDown/Off Mode) 01 = Enabled 10 = Enabled when MPC0 is high (regardless of MPC1) 11 = Enabled when MPC1 is high (regardless of MPC0)							
Buck1PFWDIs	Buck1 Freewheeling Behavior 0 = Freewheeling FET turn-on at inductor current zero-crossing. 1 = Freewheeling FET turn-on after the inductor current zero-crossing and LX node high. For voltage settings > 1.5V, this setting can improve efficiency							

Table 18. Buck1VSet Register (0x0E)

ADDRESS:	0x0E							
MODE:	Read/Write							
BIT	7	6	5	4	3	2	1	0
NAME	Buck1LowEMI	—	Buck1VSet[5:0]					
Buck1LowEMI	Buck1 BLX Rising/Falling Slopes Setting 0 = Normal rising/falling slopes on BLX 1 = Reduce the rising/falling slopes on BLX by a factor of three.							
Buck1VSet [5:0]	Buck1 Output Voltage Setting Linear Scale from 0.7V to 2.275V in 25mV increments 000000 = 0.7V 000001 = 0.725V ... 111111 = 2.275V							

Changes in output voltages are digitally ramped in 25mV increments every 80μs giving a maximum slew rates of 312.5V/s.

Table 19. Buck2Cfg Register (0x0F)

ADDRESS:	0x0F							
MODE:	Read/Write or Read-Only if Write-Protect Enabled (See Table 38)							
BIT	7	6	5	4	3	2	1	0
NAME	Buck2Seq[2:0] (Read-only)			Buck2En[1:0]		Buck2PFWDIs	Reserved	
Buck2Seq[2:0]	Buck2 Enable Configuration (Read-only) 000 = Disabled 001 = Reserved 010 = Enabled at 0% of Boot/POR Process Delay Control 011 = Enabled at 25% of Boot/POR Process Delay Control 100 = Enabled at 50% of Boot/POR Process Delay Control 101 = Reserved 110 = Reserved 111 = Controlled by Buck2En [1:0] after 100% of Boot/POR Process Delay Control							
Buck2En[1:0]	Buck2 Enable Configuration (effective only when Buck2Seq = 111) 00 = Disabled (Buck2 OUT not actively discharged unless in Hard Reset/ShutDown/Off Mode) 01 = Enabled 10 = Enabled when MPC0 is high (regardless of MPC1) 11 = Enabled when MPC1 is high (regardless of MPC0)							
Buck2PFWDIs	Buck2 Freewheeling Behavior 0 = Freewheeling FET turn-on at inductor current zero-crossing. 1 = Freewheeling FET turn-on after the inductor current zero-crossing and LX node high. For voltage settings > 1.5V, this setting can improve efficiency							

Table 20. Buck2VSet Register (0x10)

ADDRESS:	0x10							
MODE:	Read/Write or Read-Only if WriteProtect Enabled (see Table 38)							
BIT	7	6	5	4	3	2	1	0
NAME	Buck2LowEMI	—	Buck2VSet[5:0]					
Buck2LowEMI	Buck1 BLX Rising/Falling Slopes Setting 0 = Normal rising/falling slopes on BLX 1 = Reduce the rising/falling slopes on BLX by a factor of three.							
Buck2VSet [5:0]	Buck2 Output Voltage Setting Linear Scale from 0.7V to 3.85V in 50mV increments 000000 = 0.7V 000001 = 0.75V ... 111111 = 3.85V							

Changes in output voltages are digitally ramped in 50mV increments every 40µs giving a maximum slew rates of 1250V/s.

Table 21. Buck1/2ISet Register (0x11)

ADDRESS:	0x11							
MODE:	Read/Write							
BIT	7	6	5	4	3	2	1	0
NAME	Buck2ISet[3:0]				Buck1ISet[3:0]			
Buck2ISet[3:0]	Buck2 Inductor Peak current setting. 25mA step 0000 = Reserved 0001 = Reserved 0010 = 50mA ... 1111 = 375mA							
Buck1ISet[3:0]	Buck1 Inductor Peak Current Setting. 25mA step 0000 = Reserved 0001 = Reserved 0010 = 50mA ... 1111 = 375mA							

Table 22. LDO1Cfg Register (0x12)

ADDRESS:	0x12							
MODE:	Read/Write							
BIT	7	6	5	4	3	2	1	0
NAME	LDO1Seq[2:0] (Read Only)			—	LDO1Act DSC	LDO1En[1:0]		LDO1Mode
LDO1Seq[2:0]	LDO1 Enable Configuration (Read-only) 000 = Disabled 001 = Enabled always when BAT/SYS is present 010 = Enabled at 0% of Boot/POR Process Delay Control 011 = Enabled at 25% of Boot/POR Process Delay Control 100 = Enabled at 50% of Boot/POR Process Delay Control 101 = Disabled 110 = Disabled 111 = Controlled by LDO1En[1:0] after 100% of Boot/POR Process Delay Control							
LDO1ActDSC	LDO1 Active Discharge Control 0: LDO1 output will be actively discharged only in HardReset mode 1: LDO1 output will be actively discharged in HardReset mode and also when its Enable goes Low. The active discharge circuit will continue to draw additional quiescent current as long as this bit is set to 1, even when the LDO is disabled. (See EC table.)							
LDO1En[1:0]	LDO1 Enable Configuration (effective only when LDO1Seq = 111) 00 = Disabled 01 = Enabled 10 = Enabled when MPC0 is high (regardless of MPC1) 11 = Enabled when MPC1 is high (regardless of MPC0)							
LDO1Mode	LDO1 Mode Control 0 = Normal LDO operating mode 1 = Load switch mode. FET is either fully ON or OFF depending on state of LDO1En. When FET is ON, the output is unregulated. This setting is internally latched and can change only when the LDO is disabled.							

Table 23. LDO1VSet Register (0x13)

ADDRESS:	0x13							
MODE:	Read/Write or Read-Only if WriteProtect Enabled (see Table 38)							
BIT	7	6	5	4	3	2	1	0
NAME	-	-	-	LDO1Vset[4:0]				
LDO1VSet[4:0]	LDO1 Output Voltage Setting Linear Scale from 0.8V to 3.6V in 100mV increments 00000 = 0.8V 00001 = 0.9V ... 11100 = 3.6V >11101 = N/A							

Table 24. LDO2Cfg Register (0x14)

ADDRESS:	0x14							
MODE:	Read/Write or Read-Only if Write-Protect Enabled (See Table 38)							
BIT	7	6	5	4	3	2	1	0
NAME	LDO2Seq[2:0] (Read Only)			—	LDO2Act DSC	LDO2En[1:0]		LDO2 Mode
LDO2Seq[2:0]	LDO2 Enable Configuration (Read only) 000 = Disabled 001 = Enabled always when BAT/SYS is present 010 = Enabled at 0% of Boot/POR Process Delay Control 011 = Enabled at 25% of Boot/POR Process Delay Control 100 = Enabled at 50% of Boot/POR Process Delay Control 101 = Disabled 110 = Disabled 111 = Controlled by LDO2En[1:0] after 100% of Boot/POR Process Delay Control							
LDO2ActDSC	LDO2 Active Discharge Control 0 = LDO2 output will be actively discharged only in HardReset mode 1 = LDO2 output will be actively discharged in HardReset mode and also when its Enable goes Low. The active discharge circuit will continue to draw additional quiescent current as long as this bit is set to 1, even when the LDO is disabled. (See <i>Electrical Characteristics</i> table.)							
LDO2En[1:0]	LDO2 Enable Configuration (effective only when LDO2Seq = 111) 00 = Disabled – LDO's OUT not actively discharged unless HardReset/ShutDown/Off Mode 01 = Enabled 10 = Enabled when MPC0 is high (regardless of MPC1) 11 = Enabled when MPC1 is high (regardless of MPC0)							
LDO2Mode	LDO2 Mode Control 0 = Normal LDO operating mode 1 = Load switch mode. FET is either fully ON or OFF depending on state of LDO2En. When FET is ON, the output is unregulated. This setting is internally latched and can change only when the LDO is disabled.							

Table 25. LDO2VSet Register (0x15)

ADDRESS:	0x15							
MODE:	Read/Write or Read-Only if WriteProtect Enabled (see Table 38)							
BIT	7	6	5	4	3	2	1	0
NAME	—	—	—	LDO2Vset[4:0]				
LDO2VSet[4:0]	LDO2 Output Voltage Setting Linear Scale from 0.9V to 4.0V in 100mV increments 00000 = 0.9V 00001 = 1.0V ... 11111 = 4.0V							

Table 26. LDO3Cfg Register (0x16)

ADDRESS:	0x16							
MODE:	Read/Write							
BIT	7	6	5	4	3	2	1	0
NAME	LDO3Seq[2:0] (Read-Only)		—	LDO3Act DSC	LDO3En[1:0]		LDO3 Mode	
LDO3Seq[2:0]	LDO3 Enable Configuration (Read only) 000 = Disabled 001 = Enabled always when BAT/SYS is present 010 = Enabled at 0% of Boot/POR Process Delay Control 011 = Enabled at 25% of Boot/POR Process Delay Control 100 = Enabled at 50% of Boot/POR Process Delay Control 101 = Disabled 110 = Disabled 111 = Controlled by LDO3En[1:0] after 100% of Boot/POR Process Delay Control							
LDO3ActDSC	LDO3 Active Discharge Control 0 = LDO3 output will be actively discharged only in HardReset mode 1 = LDO3 output will be actively discharged in HardReset modes and also when its Enable goes Low. The active discharge circuit will continue to draw additional quiescent current as long as this bit is set to 1, even when the LDO is disabled. (See EC table.)							
LDO3En[1:0]	LDO3 Enable Configuration (effective only when LDO3Seq == 111) 00 = Disabled. LDO's OUT not actively discharged unless in HardReset/ShutDown/Off Mode 01 = Enabled 10 = Enabled when MPC0 is high (regardless of MPC1) 11 = Enabled when MPC1 is high (regardless of MPC0)							
LDO3Mode	LDO3 Mode Control 0 = Normal LDO operating mode 1 = Load switch mode. FET is either fully ON or OFF depending on state of LDO3En. When FET is ON, the output is unregulated. This setting is internally latched and can change only when the LDO is disabled.							

Table 27. LDO3VSet Register (0x17)

ADDRESS:	0x17							
MODE:	Read/Write or Read-Only if WriteProtect Enabled (see Table 38)							
BIT	7	6	5	4	3	2	1	0
NAME	—	—	—	LDO3Vset[4:0]				
LDO3VSet[4:0]	LDO3 Output Voltage Setting Linear Scale from 0.9V to 4.0V in 100mV increments 00000 = 0.9V 00001 = 1.0V ... 11111 = 4.0V							

Table 28. ThrmCfg Register (0x18)

ADDRESS:	0x18							
MODE:	Read/Write* or Read-Only if WriteProtect Enabled (see Table 38)							
BIT	7	6	5	4	3	2	1	0
NAME	T1T2IFchg[2:0]			T2T3IFchg[2:0]			ThermEn[1:0]	
T1T2IFchg[2:0]	Fast Charge Current for T1-T2 Temperature Zone 000 = 0.2 x I _{FChg} 001 = 0.3 x I _{FChg} 010 = 0.4 x I _{FChg} 011 = 0.5 x I _{FChg} 100 = 0.6 x I _{FChg} 101 = 0.7 x I _{FChg} 110 = 0.8 x I _{FChg} 111 = 1 x I _{FChg}							
T2T3IFchg[2:0]	Fast Charge Current for T2-T3 Temperature Zone 000 = 0.2 x I _{FChg} 001 = 0.3 x I _{FChg} 010 = 0.4 x I _{FChg} 011 = 0.5 x I _{FChg} 100 = 0.6 x I _{FChg} 101 = 0.7 x I _{FChg} 110 = 0.8 x I _{FChg} 111 = 1 x I _{FChg}							
ThermEn[1:0]	Thermistor Monitoring Mode 00 = Thermistor Monitoring Disabled 01 = Charging enabled between T1 and T3 10 = Charging enabled between T1 and T4 11 = Charging enabled between T1 and T4, Voltage reduced below T2 and above T3							

*Register is reset to default value upon CHGIN rising edge.

Table 29. ThrmCfg Register (0x19)

ADDRESS:	0x19							
MODE:	Read/Write* or Read-Only if WriteProtect Enabled (see Table 38)							
BIT	7	6	5	4	3	2	1	0
NAME	—	—	—	—	—	T3T4IFchg[2:0]		
T3T4IFchg[2:0]	Fast Charge Current for T3-T4 Temperature Zone 000 = 0.2 x I _{FChg} 001 = 0.3 x I _{FChg} 010 = 0.4 x I _{FChg} 011 = 0.5 x I _{FChg} 100 = 0.6 x I _{FChg} 101 = 0.7 x I _{FChg} 110 = 0.8 x I _{FChg} 111 = 1 x I _{FChg}							

*Register is reset to default value upon CHGIN rising edge.

Table 30. MONCfg Register (0x1A)

ADDRESS:	0x1A							
MODE:	Read/Write							
BIT	7	6	5	4	3	2	1	0
NAME	—	—	MONRatioCfg[1:0]		MONHiZ	MONCtr[2:0]		
MONRatioCfg	MON Resistive Partition Selector 00 = 4:1 01 = 3:1 10 = 2:1 11 = 1:1							
MONHiZ	MON OFF MODE condition 0 = Pulled LOW by 100k pull-down resistor 1 = Hi-Z							
MONCtr[2:0]	MON Pin Source selection (40μs BBM after any change of MONCtr) 000 = MON is not connected to any internal node and its state depends on MONHiZ 001 = MON connected to a resistive partition of BATT 010 = MON connected to a resistive partition of SYS 011 = MON connected to a resistive partition of BUCK1 OUT 100 = MON connected to a resistive partition of BUCK2 OUT 101 = MON connected to a resistive partition of LDO1 OUT 110 = MON connected to a resistive partition of LDO2 OUT 111 = MON connected to a resistive partition of LDO3 OUT							

Table 31. BootCfg Register (0x1B)

ADDRESS:	0x1B							
MODE:	Read-Only							
BIT	7	6	5	4	3	2	1	0
NAME	PwrRstCfg[3:0]				SftRstCfg	BootDly[1:0]		ChgAlwTry
PwrRstCfg [3:0]	See Table 1							
SftRstCfg	Soft Reset Register Default 0 = Registers do not reset to default values on soft reset 1 = Registers reset to default values on soft reset							
BootDly[1:0]	Reset Delay Control (see Figure 2a, 2b) 00 = 80ms 01 = 120ms 10 = 220ms 11 = 420ms							
ChgAlwTry	UVLO Automatic Retry If SYS UVLO condition occurs during boot process: 0 = Part latches off until CHGIN is removed and replaced 1 = Part retries after delay							

Table 32. PinStat Register (0x1C)

ADDRESS:	0x1C								
MODE:	Read Only								
BIT	7	6	5	4	3	2	1	0	
NAME	ILim_T[2:0]				-	PFN1	PFN2	MPC1	MPC0
ILim_T[2:0]	Monitor of The Input limiter Current Setting 000 = Input Limiter Off 001 = 100mA 010 = 500mA 100 = 1A								
PFN1	PFN1 Input State 0 = pin low 1 = pin high								
PFN2	PFN2 In/Out State 0 = pin low 1 = pin high								
MPC1	MPC1 Input State 0 = pin low 1 = pin high								
MPC0	MPC0 Input State 0 = pin low 1 = pin high								

Table 33. Buck1/2Extra Control Register (0x1D)

ADDRESS:	0x1D							
MODE:	Read/Write							
BIT	7	6	5	4	3	2	1	0
NAME	Buck2IAdptEnb	Buck2Fst	Buck2 ActDSC	Buck2 FFET	Buck1IAdptEnb	Buck1Fst	Buck1 ActDSC	Buck1 FFET
Buck2IAdptEnb	Buck 2 Peak Current 0 = Enable adaptive peak current 1 = Peak current set by Buck2ISet[3:0]							
Buck2Fst	Buck2 Fast Start 0 = Normal startup current limit 1 = Double the startup current to reduce the startup time by half							
Buck2ActDSC	Buck2 Active Discharge Control 0 = Buck2 output will be actively discharged only in HardReset mode 1 = Buck2 output will be actively discharged in HardReset mode and also when its Enable goes Low. Note, when BuckActDSC=1, the active discharge circuit will remain active and draw additional quiescent current even when Buck2 is disabled.							
Buck2FFET	Buck2 Force FET scaling (reduces active FET size by 50% and increases efficiency for loads <100mA.) 0 = FET Scaling disabled 1 = FET Scaling enabled							
Buck1IAdptEnb	Buck 1 Peak Current 0 = Enable adaptive peak current 1 = Peak current set by Buck1ISet[3:0]							
Buck1Fst	Buck1 Fast Start 0 = Normal startup current limit 1 = Double the startup current to reduce the startup time by half							
Buck1ActDSC	Buck1 Active Discharge Control 0 = Buck1 output will be actively discharged only in HardReset mode 1 = Buck1 output will be actively discharged in HardReset mode and also when its Enable goes Low. Note, when BuckActDSC=1, the active discharge circuit will remain active and draw additional quiescent current even when Buck2 is disabled.							
Buck1FFET	Buck1 Force FET Scaling (reduces active FET size by 50% and increases efficiency for loads <100mA.) 0 = FET Scaling only enabled during the Buck1 Turn-On Sequence 1 = FET Scaling enabled during the Buck1 Turn-On Sequence and also in the Buck1 Steady ON state							

Table 34. PwrCfg Register (0x1E)

ADDRESS:	0x1E							
MODE:	Read/Write							
BIT	7	6	5	4	3	2	1	0
NAME	PFNx ResEna	–	–	–	–	–	–	StayOn
PFNxResEna	PFN_ PFNx Automatic Internal Pull-Up/Pull-Down Enable 0 = No internal pullup/pulldown 1 = Automatic internal pullup/pulldown as per Table 1							
StayOn	This bit is used to ensure that the processor booted correctly. This bit must be set within 5s of power-on to prevent the part from shutting down and returning to the power-off condition. This bit has no effect after being set. 0 = Shut down 5s after power-on 1 = Stay on							

Table 35. PwrCmd Register (0x1F)

ADDRESS:	0x1F							
MODE:	Read/Write							
BIT	7	6	5	4	3	2	1	0
NAME	PWR_CMD[7:0]							
PWR_CMD [7:0]	Power Command Register Writing the following values issues the command listed: 0xB2 = places the part in off mode 0xC3 = issues a hard reset (power cycle) 0xD4 = issues a soft reset (reset pulse only) After the written value has been validated by the internal logic, this register is cleared automatically. Any other commands will be ignored. See Table 1 for the available PwrCmd for each PwrRstCfg value.							

Applications Information

The buck converters of the MAX20335 are optimized for use with a tiny inductor and small ceramic capacitors. The correct selection of external components ensures high efficiency, low output ripple, and fast transient response.

Inductor Selection

A 2.2μH inductor is recommended for use with the MAX20335 buck converters. [Table 36](#) lists recommended inductors for use depending on whether a given application requires highest efficiency, or a compromise between high efficiency and small size.

Output Capacitor Selection

The output capacitors of the MAX20335 buck converters are required to keep the output voltage ripple small and to ensure regulation loop stability. A 10μF output capacitor with Buck_ISet[3:0] = 150mA and Buck_IAdptEnb = 0 is suggested to cover all the possible output voltage/load current cases. If a lower output cap are needed, please refer to [Table 37](#) for the minimum allowed capacitor size). Ceramic capacitors are recommended due to their small size and low ESR and care should be taken to ensure that the selected capacitor maintains its capacitance over temperature and voltage bias. Capacitors with X5R or X7R temperature characteristics perform well in most applications.

Input Capacitor Selection

The input capacitors of the buck converters reduce the current peaks drawn from the battery or input power source and reduces switching noise in the IC. The impedance of the input capacitors at the switching frequency should be kept very low. Ceramic capacitors are recommended due to their small size and low ESR. Make sure the capacitor maintains its capacitance over temperature and DC bias. Capacitors with X5R or X7R temperature characteristics perform well in most applications.

PCB Layout and Routing

High switching frequencies and large peak currents make PCB layout a very important part of design. Good design minimizes excessive EMI on the feedback paths and voltage gradients in the ground plane, both of which can result in instability or regulation errors. Connect the inductor, input capacitor, and output capacitor as close together as possible, and keep their traces short, direct, and wide. Connect the two GND pins under the IC and directly to the grounds of the input and output capacitors. Keep noisy traces, such as the LX node, as short as possible.

Table 36. Suggested Inductors

MANUFACTURER	SERIES	INDUCTANCE (μH)	DC RESISTANCE (mΩ)	CURRENT RATING (mA)	DIMENSIONS L x W x H (mm)	NOTES
BOURNS	SRP2010	2.2	168	2200	2.0 x 1.6 x 1.0	Optimized for highest efficiency
MURATA	MFD160810	2.2	310	1400	1.6 x 0.8 x 1.0	Optimized for smallest size

Table 37. Output Capacitor Values*

BUCK_ISET[3:0]	OUTPUT VOLTAGE (V)	OUTPUT CAPACITOR MINIMUM VALUES (μF)
<150mA	>1.4V	2.2
<200mA	>1.2V	4.7
<175mA	>0.8	10

*Minimum Output Capacitor Values are given for L = 2.2μH

Table 38. Register Bit Default Values

REGISTER BITS	EVKIT	MAX20335A	MAX20335B	MAX20335D	MAX20335F	REGISTER BITS	MAX20335G
Buck1IZCSet[1:0]	20mA	10mA	20mA	10mA	20mA	Buck1IZCSet[1:0]	20mA
Buck1VSet[5:0]	1.2V	0.7V	1.8V	0.7V	1.8V	Buck1VSet[5:0]	1.8V
Buck1ISet[3:0]	150mA	150mA	150mA	150mA	150mA	Buck1ISet[3:0]	150mA
Buck1En[1:0]	Disabled	Enabled	Enabled	Disabled	Disabled	Buck1En[1:0]	Disabled
Buck1Seq[2:0]	Buck1En	Buck1En	Buck1En	Buck1En	0% Boot	Buck1Seq[2:0]	Disabled
Buck2IZCSet[1:0]	20mA	20mA	20mA	20mA	40mA	Buck2IZCSet[1:0]	30mA
Buck2VSet[5:0]	1.8V	1.8V	1.2V	1.8V	3.3V	Buck2VSet[5:0]	3V
Buck2ISet[3:0]	150mA	150mA	150mA	150mA	150mA	Buck2ISet[3:0]	200mA
Buck2En[1:0]	Disabled	Enabled	Enabled	Enabled	Disabled	Buck2En[1:0]	Enabled
Buck2Seq[2:0]	Buck2En	0% Boot	Buck2En	0% Boot	Buck2En	Buck2Seq[2:0]	0% Boot
LDO1Mode	LDO	LDO	LDO	LDO	LDO	LDO1Mode	Switch
LDO1VSet[4:0]	0.8V	3V	3.6V	3.3V	1.8V	LDO1VSet[4:0]	3V
LDO1En[1:0]	Disabled	Disabled	Enabled	Disabled	Disabled	LDO1En[1:0]	Disabled
LDO1Seq[2:0]	LDO1En	LDO1En	LDO1En	LDO1En	LDO1En	LDO1Seq[2:0]	LDO1En
LDO2Mode	LDO	Switch	Switch	LDO	LDO	LDO2Mode	LDO
LDO2VSet[4:0]	0.9V	3.5V	1.8V	3V	1.8V	LDO2VSet[4:0]	1.8V
LDO2En[1:0]	Disabled	Disabled	Enabled	Disabled	Disabled	LDO2En[1:0]	Enabled
LDO2Seq[2:0]	LDO2En	LDO2En	LDO2En	LDO2En	LDO2En	LDO2Seq[2:0]	25% Boot
LDO3Mode	LDO	Switch	LDO	LDO	LDO	LDO3Mode	LDO
LDO3VSet[4:0]	0.9V	3.5V	1.3V	3V	1.8V	LDO3VSet[4:0]	1.8V
LDO3En[1:0]	Disabled	Disabled	Enabled	Disabled	Disabled	LDO3En[1:0]	Enabled
LDO3Seq[2:0]	LDO3En	LDO3En	LDO3En	LDO3En	LDO3En	LDO3Seq[2:0]	50% Boot
VPchg[2:0]	3.00V	2.85V	3.00V	3.00V	3.00V	VPchg[2:0]	3.00V
IPChg[1:0]	0.10 x IFChg	0.10 x IFChg	0.05 x IFChg	0.20 x IFChg	0.10 x IFChg	IPChg[1:0]	0.10 x IFChg
PChgTmr[1:0]	30min	30min	30min	30min	30min	PChgTmr[1:0]	30min
FChgTmr[1:0]	150min	300min	300min	300min	150min	FChgTmr[1:0]	150min
MtChgTmr[1:0]	0min	60min	0min	30min	0min	MtChgTmr[1:0]	0min
BatReg[3:0]	4.20V	4.20V	4.20V	4.35V	4.20V	BatReg[3:0]	4.20V
BatReChg[1:0]	-220mV	-120mV	-120mV	-120mV	-70mV	BatReChg[1:0]	-220mV
ChgEn	Enabled	Enabled	Enabled	Enabled	Enabled	ChgEn	Enabled
ChgDone[1:0]	0.10 x IFChg	0.05 x IFChg	0.10 x IFChg	0.10 x IFChg	0.10 x IFChg	ChgDone[1:0]	0.10 x IFChg
ChgAutoStp	Enabled	Enabled	Enabled	Enabled	Enabled	ChgAutoStp	Enabled
ChgAutoSta	Enabled	Enabled	Enabled	Enabled	Enabled	ChgAutoSta	Enabled
FrshBatDis	Charge	Done	Charge	Charge	Charge	FrshBatDis	Charge
ThermEn[1:0]	Thermistor	JEITA 1	JEITA 1	JEITA 1	JEITA 1	ThermEn[1:0]	JEITA 2
T1_T2_IFchg[2:0]	1.0 x IFChg	1.0 x IFChg	0.5 x IFChg	0.2 x IFChg	1.0 x IFChg	T1_T2_IFchg[2:0]	0.2 x IFChg
T2_T3_IFchg[2:0]	1.0 x IFChg	1.0 x IFChg	1.0 x IFChg	1.0 x IFChg	1.0 x IFChg	T2_T3_IFchg[2:0]	1.0 x IFChg
T3_T4_IFchg[2:0]	1.0 x IFChg	1.0 x IFChg	1.0 x IFChg	0.2 x IFChg	1.0 x IFChg	T3_T4_IFchg[2:0]	1.0 x IFChg
ChgAlwTry	Retry	Retry	Retry	Latch Off	Latch Off	ChgAlwTry	Latch Off

Table 38. Register Bit Default Values (continued)

REGISTER BITS	EVKIT	MAX20335A	MAX20335B	MAX20335D	MAX20335F	REGISTER BITS	MAX20335G
ILimCntl[1:0]	500mA	500mA	500mA	500mA	500mA	ILimCntl[1:0]	500mA
PwrRstCfg[3:0]	On/Off (0000)	KIN(0110)	CR Low(0101)	Custom1(0111)	Rst Fall(0011)	PwrRstCfg[3:0]	Rst Rise(0010)
PFNxResEna	Disabled	Enabled	Disabled	Enabled	Enabled	PFNxResEna	Disabled
BootDly[1:0]	(80 + 34)ms	(120 + 34)ms	(80 + 34)ms	(80 + 34)ms	(80 + 34)ms	BootDly[1:0]	(80 + 34)ms
SftRstCfg	Reset	Hold	Reset	Reset	Reset	SftRstCfg	Reset
SysMin[2:0]	3.6V	3.6V	3.6V	3.6V	3.6V	SysMin[2:0]	3.6V
Write-Protect	Writable	Writable	Writable	Writable	Writable	Write-Protect	Writable
StayOn	Stay On	Stay On	Stay On	Stay On	Stay On	StayOn	Stay On
T1,T2,T3,T4	0,10,45,60 °C	0,10,25,45 °C	0,10,25,45 °C	0,10,45,60 °C	0,10,45,60 °C	T1,T2,T3,T4	0,10,25,45 °C

Table 39. Register Default Values

REGISTER ADDRESS	REGISTER NAME	EVKIT	MAX20335A	MAX20335B	MAX20335D	MAX20335F	REGISTER ADDRESS	REGISTER NAME	MAX20335G
0x00	ChipId	0x04	0x04	0x04	0x04	0x04	0x00	ChipId	0x04
0x01	ChipRev	0x00	0x00	0x00	0x00	0x00	0x01	ChipRev	0x00
0x07	IntMaskA	0x00	0x00	0x00	0x00	0x00	0x07	IntMaskA	0x00
0x08	IntMaskB	0x00	0x00	0x00	0x00	0x00	0x08	IntMaskB	0x00
0x09	ILimCntl	0x02	0x02	0x02	0x02	0x02	0x09	ILimCntl	0x02
0x0A	ChgCntlA	0x67	0x27	0x27	0x2D	0x07	0x0A	ChgCntlA	0x67
0x0B	ChgCntlB	0x65	0x54	0x61	0x69	0x65	0x0B	ChgCntlB	0x65
0x0C	ChTmr	0xC4	0xF8	0xC8	0xE8	0xC4	0x0C	ChTmr	0xC4
0x0D	Buck1Cfg	0xE1	0xE8	0xE9	0xE0	0x41	0x0D	Buck1Cfg	0x01
0x0E	Buck1VSet	0x14	0x00	0x2C	0x00	0x2C	0x0E	Buck1VSet	0x2C
0x0F	Buck2Cfg	0xE1	0x49	0xE9	0x49	0xE3	0x0F	Buck2Cfg	0x4A
0x10	Buck2Vset	0x16	0x16	0x0A	0x16	0x34	0x10	Buck2Vset	0x2E
0x11	BuckISet	0x66	0x66	0x66	0x66	0x66	0x11	BuckISet	0x86
0x12	LDO1Cfg	0xE0	0xE0	0xE2	0xE0	0xE0	0x12	LDO1Cfg	0xE1
0x13	LDO1VSet	0x00	0x16	0x1C	0x19	0x0A	0x13	LDO1VSet	0x16
0x14	LDO2Cfg	0xE0	0xE1	0xE3	0xE0	0xE0	0x14	LDO2Cfg	0x62
0x15	LDO2VSet	0x00	0x1A	0x09	0x15	0x09	0x15	LDO2VSet	0x09
0x16	LDO3Cfg	0xE0	0xE1	0xE2	0xE0	0xE0	0x16	LDO3Cfg	0x82
0x17	LDO3VSet	0x00	0x1A	0x04	0x15	0x09	0x17	LDO3VSet	0x09
0x18	THRMCF A	0xFD	0xFE	0x7E	0x1E	0xFE	0x18	THRMCF A	0x1F
0x19	THRMCF B	0x07	0x07	0x07	0x00	0x07	0x19	THRMCF B	0x07
0x1A	MONCF G	0x00	0x00	0x00	0x00	0x00	0x1A	MONCF G	0x00
0x1B	BOOTCF G	0x09	0x63	0x59	0x78	0x38	0x1B	BOOTCF G	0x28
0x1D	Buck1/2Extra	0x00	0x00	0x00	0x00	0x00	0x1D	Buck1/2Extra	0x00
0x1E	PwrCF g	0x01	0x81	0x01	0x81	0x81	0x1E	PwrCF g	0x01
0x1F	PwrCF d	0x00	0x00	0x00	0x00	0x00	0x1F	PwrCF d	0x00

Ordering Information

PART	TEMP RANGE	PIN-PACKAGE
MAX20335AEWX+	-40°C to +85°C	36 WLP
MAX20335AEWX+T	-40°C to +85°C	36 WLP
MAX20335BEWX+	-40°C to +85°C	36 WLP
MAX20335BEWX+T	-40°C to +85°C	36 WLP
MAX20335DEWX+	-40°C to +85°C	36 WLP
MAX20335DEWX+T	-40°C to +85°C	36 WLP
MAX20335FEWX+	-40°C to +85°C	36 WLP
MAX20335FEWX+T	-40°C to +85°C	36 WLP
MAX20335GEWX+	-40°C to +85°C	36 WLP
MAX20335GEWX+T	-40°C to +85°C	36 WLP

+Denotes a lead(Pb)-free package/RoHS-compliant package.
T = Tape and reel.

Chip Information

PROCESS: BiCMOS

Revision History

REVISION NUMBER	REVISION DATE	DESCRIPTION	PAGES CHANGED
0	3/18	Initial release	—
1	10/18	Updated the <i>Electrical Characteristics</i> table, Table 38, Table 39, and added MAX20335BEWX+ to the <i>Ordering Information</i> table	16, 64–66
2	3/19	Updated the <i>Bump Description</i> , Table 38, Table 39, and added MAX20335BEWX+T, MAX20335DEWX+ and MAX20335DEWX+T to the <i>Ordering Information</i> table	26, 64–66
3	7/19	Updated Table 38, Table 39, and added MAX20335FEWX+ and MAX20335FEWX+T to the <i>Ordering Information</i> table	64–66
4	9/19	Removed future product designation from the MAX20335FEWX+ and MAX20335FEWX+T to the <i>Ordering Information</i> table	66
5	1/20	Updated Tables 38 and 39 and added MAX20335GEWX+ and MAX20335GEWX+T to the <i>Ordering Information</i> table	64–66

For pricing, delivery, and ordering information, please visit Maxim Integrated's online storefront at <https://www.maximintegrated.com/en/storefront/storefront.html>.

Maxim Integrated cannot assume responsibility for use of any circuitry other than circuitry entirely embodied in a Maxim Integrated product. No circuit patent licenses are implied. Maxim Integrated reserves the right to change the circuitry and specifications without notice at any time. The parametric values (min and max limits) shown in the *Electrical Characteristics* table are guaranteed. Other parametric values quoted in this data sheet are provided for guidance.