

Click [here](#) for production status of specific part numbers.

MAX9979

Dual 1.1Gbps Pin Electronics with Integrated PMU and Level-Setting DACs

General Description

The MAX9979 fully integrated, high-performance, dual-channel pin electronics integrates multiple automatic test equipment (ATE) functions into a single IC, including driver/comparator/load (DCL), parametric measurement unit (PMU), and built-in (16-bit) level-setting digital-to-analog converters (DACs). The device is ideal for memory and SOC tester applications. Each channel includes a four-level pin driver, window comparator, differential comparator, dynamic clamps, a versatile PMU, an active load, a high-voltage (VHH) programmable level, and 14 independent level-setting DACs. The MAX9979 features programmable cable-droop compensation for the driver output and for the comparator input, adjustable driver output resistance that allows optimal performance over typical data-path transmission-line variations, slew-rate adjustment, and a programmable high-voltage driver output.

The MAX9979 driver features a wide 8V (-1.5V to +6.5V) high-speed operating voltage range and a VHH programmable range of up to +13V. Operation modes include high-impedance, active-termination (3rd-level drive) and VHH (4th-level drive) modes. The device is highly linear even at low voltage swings. The driver provides high-speed differential control inputs compatible with most high-speed logic families. The window comparators provide extremely low timing variation over changes in slew rate, pulse width, and overdrive voltage. In high-impedance mode, the MAX9979 features dynamic clamps that dampen high-speed device-under-test (DUT) waveforms. The 20mA active load facilitates fast contact testing when used in conjunction with the comparators, and functions as a pullup/pulldown for open-drain/collector DUT outputs. The PMU offers five current ranges from $\pm 2\mu\text{A}$ to $\pm 50\text{mA}$ and can force and measure current or voltage. An SPI™-compatible serial interface configures the MAX9979.

The MAX9979 is available in a small footprint, 68-pin (10mm x 10mm x 1mm) TQFN-EP-IDP package with exposed pad on the top for easy heat removal. Power dissipation is 1.2W per channel (typ) over the full operating voltage range with the active load disabled. The MAX9979 operates over an internal die temperature range of +40°C to +100°C and provides a temperature monitor output.

Applications

- Memory ATE Testers
- SOC ATE Testers

SPI is a trademark of Motorola, Inc.

Features

- High Speed: 1.1Gbps at 1V_{P-P}
- Extremely Low Power Dissipation: 1.2W/Channel (Active Load Disabled)
- Wide Voltage Range: -1.5V to +6.5V and Up to 13V VHH
- Wide Voltage Swing Range: 50mV_{P-P} to 13V_{P-P}
- Low-Leak Mode: 10nA max
- Integrated Termination-on-the-Fly (3rd-Level Drive)
- Integrated VHH High Voltage (4th-Level Drive)
- Integrated Voltage Clamps
- Integrated 20mA Active Load
- Integrated Per-Pin PMU
- Integrated Level-Setting CALDACs
- Programmable Cable-Droop Compensation for Both Driver Output and Comparator Input
- Programmable Driver Output Impedance
- Four Slew-Rate Settings for Driver Output
- Analog Measure Bus
- Very Low Timing Dispersion
- Minimal External Component Count
- SPI-Compatible Serial Control Interface
- 68-Pin Thermally Enhanced TQFN Package with Top-Side Heat Removal

Ordering Information

PART	TEMP RANGE	PIN-PACKAGE
MAX9979KCTK+	0°C TO +70°C	68 TQFN-EP-IDP*

+Denotes a lead(Pb)-free/RoHS-compliant package.

*EP-IDP = Exposed pad, inverted die pad.

Pin Configuration and Typical Operating Circuit appear at end of data sheet

Absolute Maximum Ratings

V _{CC} to GND-0.3V to +11V	TEMP to GND0 to V _{CC}
V _{EE} to GND-5.5V to +0.3V	MEAS ₋ to GND(V _{EE} - 0.3V) to (V _{CC} + 0.3V)
V _{CC} to V _{EE}-0.3V to +16.5V	REF to GND-0.3V to (2.6V + V _{DGS})
V _{DD} to DGND-0.3V to +5.2V	Current into SCLK, DIN, CS, RST, LOAD±30mA
V _{HHP} to GND-0.3V to +19V	Current into LLEAKP ₋ , HIZMEASP ₋ , ENVHHP ₋ , DUTHI ₋ , DUTLO ₋±30mA
DGND to GND±0.3V	PMU-F Continuous Current±35mA
CTV ₋ , BV ₋ to GND-0.3V to +5V	PMU-F Peak Current±70mA
DATA ₋ , NDATA ₋ , RCV ₋ , NRCV ₋ to GND(V _{EE} - 0.3V) to (V _{BV₋} + 0.3V)	PMU-S Continuous Current±1mA
CH ₋ , NCH ₋ , CL ₋ , NCL ₋ to GND-1.5V to (V _{CTV₋} + 0.3V)	PMU-S Peak Current±20mA
Current into CH ₋ , NCH ₋ , CL ₋ , NCL ₋±35mA	DGS to GND±0.3V
DATA ₋ to NDATA ₋ , RCV ₋ to NRCV ₋±1V	DUT ₋ , SENSE ₋ Short-Circuit Duration to V _{CC} , V _{EE}Continuous
DUT ₋ , PMU-F, PMU-S, SENSE ₋ to GND (non-V _{HH} mode)(V _{EE} - 0.3V) to (V _{CC} + 0.3V)	Power Dissipation (T _A = +70°C)* MAX9979KCTK (derate 125mW/°C above +70°C)10W
DUT ₋ , PMU-F, PMU-S, SENSE ₋ to GND (V _{HH} mode)-3.5V to +13.5V	Storage Temperature Range-65°C to +150°C
SCLK, DIN, CS, RST, LOAD to GND-0.3V to (V _{DD} + 0.3V)	Maximum Junction Temperature+150°C
LLEAKP ₋ , HIZMEASP ₋ , ENVHHP ₋ , DUTHI ₋ , DUTLO ₋ to GND-0.3V to (V _{DD} + 0.3V)	Lead Temperature (soldering, 10s)+300°C

*Dissipation wattage values are based on still air with no heatsink. Actual maximum power dissipation is a function of heat extraction technique and may be substantially higher.

Stresses beyond those listed under "Absolute Maximum Ratings" may cause permanent damage to the device. These are stress ratings only, and functional operation of the device at these or any other conditions beyond those indicated in the operational sections of the specifications is not implied. Exposure to absolute maximum rating conditions for extended periods may affect device reliability.

Package Thermal Characteristics**

TQFN

Junction-to-Case Thermal Resistance (θ _{JA})8.0°C/W
Junction-to-Ambient Thermal Resistance (θ _{JC})0.3°C/W

**Package thermal resistances were obtained using the method described in JEDEC specification JESD51-7, using a fourlayer board. For detailed information on package thermal considerations, refer to www.maximintegrated.com/thermal-tutorial.

Electrical Characteristics

(V_{CC} = 9.75V, V_{EE} = -4.75V, V_{DD} = 3.3V, V_{HHP} = 17.5V, V_{DHV} = 3V, V_{DLV} = 0V, V_{DTV} = 1.5V, SC1 = SC0 = 0V, V_{C_{PHV}} = 7.2V, V_{C_{PLV}} = -2.2V, V_{CTV} = 1.4V, V_{BV} = 4V, V_{DGS} = V_{GND} = 0V, V_{CHV} = V_{IVMAX} = 2V, V_{CLV} = V_{IVMIN} = 1V, V_{COM} = 2.5V, V_{LDHV} = 0V, V_{LDLV} = 0V, V_{IN} = 2.5V, V_{V_{IOS}} = 0V, V_{V_IIOS} = 2.5V, V_{CLAMP_{HI}} = 5V, V_{CLAMP_{LO}} = 0V, V_{HH} = 10V, CDRP = 0b001, RO = 0b1000, HYST = 0b000, Z_{LOAD} = 50Ω, T_J = +70°C to an accuracy of ±15°C, unless otherwise noted. All temperature coefficients are measured at T_J = +40°C to +100°C, unless otherwise noted.) (Note 1)

PARAMETER	SYMBOL	CONDITIONS	MIN	TYP	MAX	UNITS
DRIVER						
DC CHARACTERISTICS (R_L ≥ 10MΩ, unless otherwise noted; includes DAC error)						
Output-Voltage Range	V _{DHV}	V _{DLV} = -1.5V, V _{DTV} = 1.5V	-1.45 to +6.50		V	
	V _{DLV}	V _{DHV} = 6.5V, V _{DTV} = 1.5V	-1.50 to +6.45			
	V _{DTV}	V _{DHV} = 6.5V, V _{DLV} = -1.5V (Note 2)	-1.50	+6.50		
Output Offset Voltage	V _{DHV}	V _{DHV} = 3V, V _{DLV} = -1.5V, V _{DTV} = 1.5V	±5		mV	
	V _{DLV}	V _{DLV} = 0V, V _{DHV} = 6.5V, V _{DTV} = 1.5V	±5			
	V _{DTV}	V _{DTV} = 1.5V, V _{DHV} = 6.5V, V _{DLV} = -1.5V	±5			
Output-Voltage Temperature Coefficient (Notes 3, 4)		DHV ₋ , DLV ₋ , DTV ₋		±75	±500	µV/°C

Electrical Characteristics (continued)

(V_{CC} = 9.75V, V_{EE} = -4.75V, V_{DD} = 3.3V, V_{HHP} = 17.5V, V_{DHV} = 3V, V_{DLV} = 0V, V_{DTV} = 1.5V, SC1 = SC0 = 0V, V_{CPHV} = 7.2V, V_{CPLV} = -2.2V, V_{CTV} = 1.4V, V_{BV} = 4V, V_{DGS} = V_{GND} = 0V, V_{CHV} = V_{IIVMAX} = 2V, V_{CLV} = V_{IIVMIN} = 1V, V_{COM} = 2.5V, V_{LDHV} = 0V, V_{LDLV} = 0V, V_{IN} = 2.5V, V_{VIOS} = 0V, V_{IIOS} = 2.5V, V_{CLAMPHI} = 5V, V_{CLAMPLO} = 0V, V_{HH} = 10V, CDRP = 0b001, RO = 0b1000, HYST = 0b000, Z_{LOAD} = 50Ω, T_J = +70°C to an accuracy of ±15°C, unless otherwise noted. All temperature coefficients are measured at T_J = +40°C to +100°C, unless otherwise noted.) (Note 1)

PARAMETER	SYMBOL	CONDITIONS	MIN	TYP	MAX	UNITS
Gain	A _{DHV}	V _{DLV} = -1.5V, V _{DTV} = 1.5V, V _{DHV} = 0V and 4.5V	0.998	1	1.002	V/V
	A _{DLV}	V _{DHV} = 6.5V, V _{DTV} = 1.5V, V _{DLV} = 0V and 4.5V	0.998	1	1.002	
	A _{DTV}	V _{DHV} = 6.5V, V _{DLV} = -1.5V, V _{DTV} = 0V and 4.5V	0.998	1	1.002	
Linearity Error	0 to 3V relative to calibration points at 0 and 3V	V _{DLV} = -1.5V, V _{DTV} = 1.5V, V _{DHV} = 0V, 0.75V, 1.5V, 2.25V, 3V			±2	mV
		V _{DHV} = 6.5V, V _{DTV} = 1.5V, V _{DLV} = 0V, 0.75V, 1.5V, 2.25V, 3V			±2	
		V _{DLV} = -1.5V, V _{DHV} = 6.5V, V _{DTV} = 0V, 0.75V, 1.5V, 2.25V, 3V			±2	
	-1V to 6V relative to calibration points at 0 and 3V	V _{DLV} = -1.5V, V _{DTV} = 1.5V, V _{DHV} = -1V and 6V			±4.5	
		V _{DHV} = 6.5V, V _{DTV} = 1.5V, V _{DLV} = -1V and 6V			±4.5	
		V _{DLV} = -1.5V, V _{DHV} = 6.5V, V _{DTV} = -1V and 6V			±4.5	
	Full range relative to calibration points at 0 and 3V	V _{DLV} = -1.5V, V _{DTV} = 1.5V, V _{DHV} = -1.25V and 6.5V			±6	
		V _{DHV} = 6.5V, V _{DTV} = 1.5V, V _{DLV} = -1.5V and 6.25V			±6	
		V _{DLV} = -1.5V, V _{DHV} = 6.5V, V _{DTV} = -1.5V and 6.5V			±6	

Electrical Characteristics (continued)

($V_{CC} = 9.75V$, $V_{EE} = -4.75V$, $V_{DD} = 3.3V$, $V_{HHP} = 17.5V$, $V_{DHV_} = 3V$, $V_{DLV_} = 0V$, $V_{DTV_} = 1.5V$, $SC1 = SC0 = 0V$, $V_{CPHV_} = 7.2V$, $V_{CPLV_} = -2.2V$, $V_{CTV_} = 1.4V$, $V_{BV_} = 4V$, $V_{DGS} = V_{GND} = 0V$, $V_{CHV_} = V_{IVMAX_} = 2V$, $V_{CLV_} = V_{IVMIN_} = 1V$, $V_{COM_} = 2.5V$, $V_{LDHV_} = 0V$, $V_{LDLV_} = 0V$, $V_{IN_} = 2.5V$, $V_{VIOS} = 0V$, $V_{IIOS} = 2.5V$, $V_{CLAMPHI_} = 5V$, $V_{CLAMPLO_} = 0V$, $V_{HH_} = 10V$, $CDRP = 0b001$, $RO = 0b1000$, $HYST = 0b000$, $Z_{LOAD} = 50\Omega$, $T_J = +70^\circ C$ to an accuracy of $\pm 15^\circ C$, unless otherwise noted. All temperature coefficients are measured at $T_J = +40^\circ C$ to $+100^\circ C$, unless otherwise noted.) (Note 1)

PARAMETER	SYMBOL	CONDITIONS	MIN	TYP	MAX	UNITS
Crosstalk		DHV_ to DLV_ $V_{DLV_} = 0V$, $V_{DTV_} = 1.5V$, $V_{DHV_} = 0.2V$ and $6.5V$			± 7	mV
		DLV_ to DHV_ $V_{DHV_} = 5V$, $V_{DTV_} = 1.5V$, $V_{DLV_} = -1.5$ and $4.8V$			± 7	
		DTV_ to DLV_ and DHV_ $V_{DHV_} = 3V$, $V_{DLV_} = 0V$, $V_{DTV_} = -1.5V$ and $6.5V$			± 2	
		DHV_ to DTV_ $V_{DTV_} = 1.5V$, $V_{DLV_} = 0V$, $V_{DHV_} = 1.6V$ and $3V$			± 3	
		DLV_ to DTV_ $V_{DTV_} = 1.5V$, $V_{DHV_} = 3V$, $V_{DLV_} = 0$ and $1.4V$			± 3	
Term Voltage		Dependence on DATA_ $V_{DTV_} = 1.5V$, $V_{DHV_} =$ $3V$, $V_{DLV_} = 0V$, DATA_ = 0 and 1			± 2	mV
DC Power-Supply Rejection (Note 5)		DHV_ $V_{DHV_} = 3V$	40			dB
		DLV_ $V_{DLV_} = 0V$	40			
		DTV_ $V_{DTV_} = 1.5V$	40			
DC Drive Current Limit		$V_{DHV_} = 6.5V$, $V_{DLV_} = -1.5V$ DATA_ = 1, $V_{DUT_} = -1.5V$	+60		+110	mA
		DATA_ = 0, $V_{DUT_} = 6.5V$	-110		-60	
DC Output Resistance		(Note 6)	48	50	52	Ω
DC Output Resistance Variation (Note 7)		DATA_ = 1, $V_{DHV_} = 3V$, $V_{DLV_} = 0V$, $V_{DTV_} =$ $1.5V$, $I_{DUT_} = 1mA$, $8mA$, $15mA$, $40mA$		1	2	Ω
		DATA_ = 0, $V_{DHV_} = 3V$, $V_{DLV_} = 0V$, $V_{DTV_} =$ $1.5V$, $I_{DUT_} = -1mA$, $-8mA$, $-15mA$, $-40mA$		1	2	
Adjustable Output Resistance Range		$R_O = 0xF$ vs. $R_O = 0x8$ and $R_O = 0x0$ vs. $R_O = 0x8$, resolution of 0.36Ω (Note 6)		± 2.5		Ω

Electrical Characteristics (continued)

($V_{CC} = 9.75V$, $V_{EE} = -4.75V$, $V_{DD} = 3.3V$, $V_{HHP} = 17.5V$, $V_{DHV} = 3V$, $V_{DLV} = 0V$, $V_{DTV} = 1.5V$, $SC1 = SC0 = 0V$, $V_{CPHV} = 7.2V$, $V_{CPLV} = -2.2V$, $V_{CTV} = 1.4V$, $V_{BV} = 4V$, $V_{DGS} = V_{GND} = 0V$, $V_{CHV} = V_{IVMAX} = 2V$, $V_{CLV} = V_{IVMIN} = 1V$, $V_{COM} = 2.5V$, $V_{LDHV} = 0V$, $V_{LDLV} = 0V$, $V_{IN} = 2.5V$, $V_{VIOS} = 0V$, $V_{IIOS} = 2.5V$, $V_{CLAMPHI} = 5V$, $V_{CLAMPLO} = 0V$, $V_{HH} = 10V$, $CDRP = 0b001$, $RO = 0b1000$, $HYST = 0b000$, $Z_{LOAD} = 50\Omega$, $T_J = +70^\circ C$ to an accuracy of $\pm 15^\circ C$, unless otherwise noted. All temperature coefficients are measured at $T_J = +40^\circ C$ to $+100^\circ C$, unless otherwise noted.) (Note 1)

PARAMETER	SYMBOL	CONDITIONS	MIN	TYP	MAX	UNITS
AC CHARACTERISTICS ($R_{DUT} = 50\Omega$ to Ground) (Note 8)						
Dynamic Drive Current				±130		mA
Drive-Mode Overshoot		Cable-droop compensation off, $V_{DLV} = 0V$, $V_{DHV} = 0.1V$		30		mV
		Cable-droop compensation off, $V_{DLV} = 0V$, $V_{DHV} = 1V$		40		
		Cable-droop compensation off, $V_{DLV} = 0V$, $V_{DHV} = 3V$		50		
		Cable-droop compensation off, $V_{DLV} = 0V$, $V_{DHV} = 5V$		50		
Cable-Droop Compensation		$V_{DLV} = 0V$, $V_{DHV} = 3V$, $CDRP = 0b000$		0		%
		$V_{DLV} = 0V$, $V_{DHV} = 3V$, $CDRP = 0b111$		10		
Termination-Mode Overshoot		Cable-droop compensation off (Note 10)		0		mV
Settling Time (Notes 4, 11)		To within 100mV, $V_{DHV} = 5V$, $V_{DLV} = 0V$		0.25	1	ns
		To within 50mV, $V_{DHV} = 3V$, $V_{DLV} = 0V$		0.25	1	
		To within 50mV, $V_{DHV} = 0.5V$, $V_{DLV} = 0V$		0.25	1	
TIMING CHARACTERISTICS (Notes 8, 12)						
Propagation Delay		Data to output, $V_{DHV} = 3V$, $V_{DLV} = 0V$ (Note 13)	1	1.9	4	ns
		Drive to term, term to drive (Notes 4, 14)	1.7	2.7	3.7	
		Drive to high impedance, high impedance to drive, $V_{DHV} = 1V$, $V_{DLV} = -1V$ (Notes 4, 15)	1.4	2.4	3.4	
Propagation-Delay Match		t_{LH} vs. t_{HL} (Note 4)		±40	±80	ps
		Drivers within package, same edge		±40		
		Drive to high impedance vs. high impedance to drive, $V_{DHV} = 1V$, $V_{DLV} = -1V$ (Note 16)		±0.5		ns
		High impedance vs. data		±0.5		
		Drive to term vs. term to drive, $V_{DHV} = 3V$, $V_{DLV} = 0V$, $V_{DTV} = 1.5V$ (Note 17)		±0.3		
		Terminate vs. data		±0.8		
Propagation-Delay Channel Match		Differential mode, $V_{DHV} = 1V$, $V_{DLV} = 0V$, channel 1 inverted, $DIFFERENTIAL0 = 1$, $INVERT1 = 1$		±40		ps

Electrical Characteristics (continued)

($V_{CC} = 9.75V$, $V_{EE} = -4.75V$, $V_{DD} = 3.3V$, $V_{HHP} = 17.5V$, $V_{DHV_} = 3V$, $V_{DLV_} = 0V$, $V_{DTV_} = 1.5V$, $SC1 = SC0 = 0V$, $V_{CPHV_} = 7.2V$, $V_{CPLV_} = -2.2V$, $V_{CTV_} = 1.4V$, $V_{BV_} = 4V$, $V_{DGS} = V_{GND} = 0V$, $V_{CHV_} = V_{IVMAX_} = 2V$, $V_{CLV_} = V_{IVMIN_} = 1V$, $V_{COM_} = 2.5V$, $V_{LDHV_} = 0V$, $V_{LDLV_} = 0V$, $V_{IN_} = 2.5V$, $V_{VIOS} = 0V$, $V_{IIOS} = 2.5V$, $V_{CLAMPHI_} = 5V$, $V_{CLAMPLO_} = 0V$, $V_{HH_} = 10V$, $CDRP = 0b001$, $RO = 0b1000$, $HYST = 0b000$, $Z_{LOAD} = 50\Omega$, $T_J = +70^\circ C$ to an accuracy of $\pm 15^\circ C$, unless otherwise noted. All temperature coefficients are measured at $T_J = +40^\circ C$ to $+100^\circ C$, unless otherwise noted.) (Note 1)

PARAMETER	SYMBOL	CONDITIONS	MIN	TYP	MAX	UNITS
Propagation-Delay Temperature Coefficient		$V_{DHV_} = 3V$, $V_{DLV_} = 0V$ (Note 4)		3	5	ps/ $^\circ C$
Propagation-Delay Change	Change vs. pulse width (Note 18)	$V_{DHV_} = 1V$, $V_{DLV_} = 0V$, 1ns to 24ns pulse width (Note 4)		± 25	± 60	ps
		$V_{DHV_} = 3V$, $V_{DLV_} = 0V$, 1ns to 24ns pulse width (Note 4)		± 35	± 60	
		$V_{DHV_} = 5V$, $V_{DLV_} = 0V$, 1.5ns to 23.5ns pulse width		± 100		
		Peak-to-peak change vs. common mode, $V_{DHV_} - V_{DLV_} = 1V$, $V_{DHV_} = 0$ to 6V, using a DC-blocking capacitor (Note 4)		50	60	
Rise-and-Fall Time		0.2V _{P-P} programmed, $V_{DHV_} = 0.2V$, $V_{DLV_} = 0V$, 20% to 80%		275		ps
		1V _{P-P} programmed, $V_{DHV_} = 1V$, $V_{DLV_} = 0V$, 10% to 90%	330	450	550	
		3V _{P-P} programmed, $V_{DHV_} = 3V$, $V_{DLV_} = 0V$, 10% to 90%, trim condition	500	650	800	
		5V _{P-P} programmed, $V_{DHV_} = 5V$, $V_{DLV_} = 0V$, 10% to 90% (Note 4)	800	1000	1200	
Rise-and-Fall Time Matching		0.2V _{P-P} programmed, $V_{DHV_} = 0.2V$, $V_{DLV_} = 0V$, 20% to 80%		± 40		ps
		1V _{P-P} programmed, $V_{DHV_} = 1V$, $V_{DLV_} = 0V$, 10% to 90%		± 50	± 130	
		3V _{P-P} programmed, $V_{DHV_} = 3V$, $V_{DLV_} = 0V$, 10% to 90%		± 50	± 200	
		5V _{P-P} programmed, $V_{DHV_} = 5V$, $V_{DLV_} = 0V$, 10% to 90%		± 50		

Electrical Characteristics (continued)

(V_{CC} = 9.75V, V_{EE} = -4.75V, V_{DD} = 3.3V, V_{HHP} = 17.5V, V_{DHV₋} = 3V, V_{DLV₋} = 0V, V_{DTV₋} = 1.5V, SC1 = SC0 = 0V, V_{CPHV₋} = 7.2V, V_{CPLV₋} = -2.2V, V_{CTV₋} = 1.4V, V_{BV₋} = 4V, V_{DGS} = V_{GND} = 0V, V_{CHV₋} = V_{IIVMAX₋} = 2V, V_{CLV₋} = V_{IIVMIN₋} = 1V, V_{COM₋} = 2.5V, V_{LDHV₋} = 0V, V_{LDLV₋} = 0V, V_{IN₋} = 2.5V, V_{VIOS} = 0V, V_{IIOS} = 2.5V, V_{CLAMPHI₋} = 5V, V_{CLAMPLO₋} = 0V, V_{HH₋} = 10V, CDRP = 0b001, RO = 0b1000, HYST = 0b000, Z_{LOAD} = 50Ω, T_J = +70°C to an accuracy of ±15°C, unless otherwise noted. All temperature coefficients are measured at T_J = +40°C to +100°C, unless otherwise noted.) (Note 1)

PARAMETER	SYMBOL	CONDITIONS	MIN	TYP	MAX	UNITS
Slew Rate		SC1 = 0, SC0 = 1, V _{DHV₋} = 3V, V _{DLV₋} = 0V, 20% to 80%		75		%
		SC1 = 1, SC0 = 0, V _{DHV₋} = 3V, V _{DLV₋} = 0V, 20% to 80%		50		
		SC1 = 1, SC0 = 1, V _{DHV₋} = 3V, V _{DLV₋} = 0V, 20% to 80%		25		
Minimum Pulse Width		0.2V _{P-P} programmed, V _{DHV₋} = 0.2V, V _{DLV₋} = 0V (Note 19)		800		ps
		1V _{P-P} programmed, V _{DHV₋} = 1V, V _{DLV₋} = 0V (Note 19)		950		
		3V _{P-P} programmed, V _{DHV₋} = 3V, V _{DLV₋} = 0V (Notes 4, 19)		1000	1450	
		5V _{P-P} programmed, V _{DHV₋} = 5V, V _{DLV₋} = 0V (Note 19)		1300		
Data Rate	To 95% _{P-P} (Note 20)	0.2V _{P-P} programmed, V _{DHV₋} = 0.2V, V _{DLV₋} = 0V		1100		Mbps
		1V _{P-P} programmed, V _{DHV₋} = 1V, V _{DLV₋} = 0V		900		
		3V _{P-P} programmed, V _{DHV₋} = 3V, V _{DLV₋} = 0V		800		
		5V _{P-P} programmed, V _{DHV₋} = 5V, V _{DLV₋} = 0V		680		
	To 90% _{P-P} (Note 21)	0.2V _{P-P} programmed, V _{DHV₋} = 0.2V, V _{DLV₋} = 0V		1200		
		1V _{P-P} programmed, V _{DHV₋} = 1V, V _{DLV₋} = 0V		1100		
		3V _{P-P} programmed, V _{DHV₋} = 3V, V _{DLV₋} = 0V		900		
		5V _{P-P} programmed, V _{DHV₋} = 5V, V _{DLV₋} = 0V		720		

Electrical Characteristics (continued)

($V_{CC} = 9.75V$, $V_{EE} = -4.75V$, $V_{DD} = 3.3V$, $V_{HHP} = 17.5V$, $V_{DHV} = 3V$, $V_{DLV} = 0V$, $V_{DTV} = 1.5V$, $SC1 = SC0 = 0V$, $V_{CPHV} = 7.2V$, $V_{CPLV} = -2.2V$, $V_{CTV} = 1.4V$, $V_{BV} = 4V$, $V_{DGS} = V_{GND} = 0V$, $V_{CHV} = V_{IVMAX} = 2V$, $V_{CLV} = V_{IVMIN} = 1V$, $V_{COM} = 2.5V$, $V_{LDHV} = 0V$, $V_{LDLV} = 0V$, $V_{IN} = 2.5V$, $V_{VIOS} = 0V$, $V_{IIOS} = 2.5V$, $V_{CLAMPHI} = 5V$, $V_{CLAMPLO} = 0V$, $V_{HH} = 10V$, $CDRP = 0b001$, $RO = 0b1000$, $HYST = 0b000$, $Z_{LOAD} = 50\Omega$, $T_J = +70^\circ C$ to an accuracy of $\pm 15^\circ C$, unless otherwise noted. All temperature coefficients are measured at $T_J = +40^\circ C$ to $+100^\circ C$, unless otherwise noted.) (Note 1)

PARAMETER	SYMBOL	CONDITIONS	MIN	TYP	MAX	UNITS
Rise-and-Fall Time		Drive to term, $V_{DHV} = 3V$, $V_{DLV} = 0V$, $V_{DTV} = 1.5V$, measured 10% to 90% of waveform	300	500	1000	ps
		Term to drive, $V_{DHV} = 3V$, $V_{DLV} = 0V$, $V_{DTV} = 1.5V$, measured 10% to 90% of waveform	300	600	850	
HIGH-SPEED COMPARATORS						
DC CHARACTERISTICS						
Input-Voltage Range		(Notes 2, 22)	-1.5		+6.5	V
Differential Input Voltage		$V_{DUT} - V_{CHV}$, $V_{DUT} - V_{CLV}$ (Note 23)			± 8	V
Input Offset Voltage		$V_{DUT} = 1.5V$		± 1	± 5	mV
Input-Voltage Temperature Coefficient		(Notes 4, 24)		± 50	± 175	$\mu V^\circ C$
Common-Mode Rejection Ratio	CMRR	$V_{DUT} = -1.5V, 6.5V$ (Note 25)	50	55		dB
Linearity Error (Note 26)		0 to 3V, $V_{DUT} = 0, 1.5V, 3V$		± 1	± 5	mV
		Full range, $V_{DUT} = -1.5V, 0, 1.5V, 3V, 6.5V$		± 1	± 10	
Power-Supply Rejection Ratio	PSRR	$V_{DUT} = -1.5$ and $6.5V$ (Notes 5, 27)	50	66		dB
Hysteresis		HYST0	HYST1	HYST2		mV
		0	0	0	0	
		0	0	1	2	
		0	1	0	4	
		0	1	1	6	
		1	0	0	8	
		1	0	1	10	
		1	1	0	12	
		1	1	1	15	
AC CHARACTERISTICS (Notes 4, 28, 29, 30)						
Minimum Pulse Width		(Note 31)		0.50	0.65	ns
Propagation Delay			0.5	0.9	1.5	ns
Propagation-Delay Temperature Coefficient				1.7		$ps^\circ C$
Propagation-Delay Match		High/low vs. low/high, absolute value of delta for each comparator		± 10	± 85	ps
Propagation-Delay Dispersion vs. Common-Mode Input		-1.4V to +6.4V (Note 32)		40	55	ps_{P-P}
Propagation-Delay Dispersion vs. Duty Cycle		0.6ns to 24.4ns pulse width, relative to 5ns pulse width		± 25	± 40	ps
Propagation-Delay Dispersion vs. Slew Rate		1V/ns to 6V/ns, relative to 2V/ns (Note 33)		± 30	± 55	ps

Electrical Characteristics (continued)

($V_{CC} = 9.75V$, $V_{EE} = -4.75V$, $V_{DD} = 3.3V$, $V_{HHP} = 17.5V$, $V_{DHV} = 3V$, $V_{DLV} = 0V$, $V_{DTV} = 1.5V$, $SC1 = SC0 = 0V$, $V_{CPHV} = 7.2V$, $V_{CPLV} = -2.2V$, $V_{CTV} = 1.4V$, $V_{BV} = 4V$, $V_{DGS} = V_{GND} = 0V$, $V_{CHV} = V_{IVMAX} = 2V$, $V_{CLV} = V_{IVMIN} = 1V$, $V_{COM} = 2.5V$, $V_{LDHV} = 0V$, $V_{LDLV} = 0V$, $V_{IN} = 2.5V$, $V_{VIOS} = 0V$, $V_{IIOS} = 2.5V$, $V_{CLAMPHI} = 5V$, $V_{CLAMPLO} = 0V$, $V_{HH} = 10V$, $CDRP = 0b001$, $RO = 0b1000$, $HYST = 0b000$, $Z_{LOAD} = 50\Omega$, $T_J = +70^\circ C$ to an accuracy of $\pm 15^\circ C$, unless otherwise noted. All temperature coefficients are measured at $T_J = +40^\circ C$ to $+100^\circ C$, unless otherwise noted.) (Note 1)

PARAMETER	SYMBOL	CONDITIONS	MIN	TYP	MAX	UNITS
Equivalent 20–80 Bandwidth		$V_{DTV} = 0.5V$, driver terminated (Note 34)	1000	1500		MHz
		Driver high impedance		700		
Cable-Droop Compensation, Peaking		1V swing, rise/fall time = 500ps, DRV terminated	CDRP = 0b000	0		%
			CDRP = 0b111	10		
LOGIC OUTPUTS (CH_, NCH_, CL_, NCL_ collector output, RL = 50Ω internal pullup to CTV)						
Termination Voltage	CTV_		0		3.5	V
Output High Current				0		mA
Output Low Current				16		mA
Output-Voltage Compliance		Set by I_{OUT} , R_{TERM} and V_{CTV}	-0.5		CTV_	V
Differential Rise Time		20% to 80% (Note 4)		200	400	ps
Differential Fall Time		20% to 80% (Note 4)		200	400	ps
Termination Resistor Value		CTV_ to CH_, NCH_, CL_, NCL_	48		52	Ω
Output High Voltage	V_{OH}	With output resistors, R_{TERM} to V_{CTV} (Note 56)	CTV_ - 0.1	CTV_ - 0.02	CTV_	V
Output Low Voltage	V_{OL}	With output resistors, R_{TERM} to V_{CTV} (Note 56)	CTV_ - 0.55	CTV_ - 0.4	CTV_ - 0.35	V
Output-Voltage Swing		With output resistors, 50Ω nominal trim (Note 56)	350	400	450	mV
DYNAMIC CLAMPS						
CPHV_ Functional Clamp Range		$I_{DUT} = -1mA$, $V_{CPLV} = -1.5V$ (Note 2)	-0.3		+6.5	V
CPLV_ Functional Clamp Range		$I_{DUT} = 1mA$, $V_{CPHV} = 6.5V$ (Note 2)	-1.5		+5.3	V
CPHV_ Maximum Programmable Voltage		$I_{DUT} = 0$ (Note 23)	7.2	7.5		V
CPLV_ Minimum Programmable Voltage		$I_{DUT} = 0$ (Note 23)		-2.5	-2.2	V
Offset Voltage		$I_{DUT} = -1mA$, $V_{CPHV} = 1.5V$, $V_{CPLV} = -1.5V$			±10	mV
		$I_{DUT} = 1mA$, $V_{CPLV} = 1.5V$, $V_{CPHV} = 6.5V$			±10	
Offset-Voltage Temperature Coefficient		$V_{CPHV} = V_{CPLV} = 1.5V$		0.5		mV/°C
Power-Supply Rejection Ratio		$I_{DUT} = -1mA$, $V_{CPHV} = 1.5V$, $V_{CPLV} = -1.5V$ (Note 5)	40			dB
		$I_{DUT} = +1mA$, $V_{CPLV} = 1.5V$, $V_{CPHV} = 6.5V$ (Note 5)	40			
High Clamp Voltage Gain		$V_{CPHV} = -0.3V$, 6.5V	0.998		1.002	V/V
Low Clamp Voltage Gain		$V_{CPLV} = -1.5V$, 5.3V	0.998		1.002	V/V
Voltage-Gain Temperature Coefficient				100		ppm/°C

Electrical Characteristics (continued)

($V_{CC} = 9.75V$, $V_{EE} = -4.75V$, $V_{DD} = 3.3V$, $V_{HHP} = 17.5V$, $V_{DHV} = 3V$, $V_{DLV} = 0V$, $V_{DTV} = 1.5V$, $SC1 = SC0 = 0V$, $V_{CPHV} = 7.2V$, $V_{CPLV} = -2.2V$, $V_{CTV} = 1.4V$, $V_{BV} = 4V$, $V_{DGS} = V_{GND} = 0V$, $V_{CHV} = V_{IVMAX} = 2V$, $V_{CLV} = V_{IVMIN} = 1V$, $V_{COM} = 2.5V$, $V_{LDHV} = 0V$, $V_{LDLV} = 0V$, $V_{IN} = 2.5V$, $V_{VIOS} = 0V$, $V_{IIOS} = 2.5V$, $V_{CLAMPHI} = 5V$, $V_{CLAMPLO} = 0V$, $V_{HH} = 10V$, $CDRP = 0b001$, $RO = 0b1000$, $HYST = 0b000$, $Z_{LOAD} = 50\Omega$, $T_J = +70^\circ C$ to an accuracy of $\pm 15^\circ C$, unless otherwise noted. All temperature coefficients are measured at $T_J = +40^\circ C$ to $+100^\circ C$, unless otherwise noted.) (Note 1)

PARAMETER	SYMBOL	CONDITIONS	MIN	TYP	MAX	UNITS
Linearity		$I_{DUT} = -1mA$, $V_{CPHV} = -0.3V, 1.5V, 3.25V, 5V, 6.5V$			± 30	mV
		$I_{DUT} = 1mA$, $V_{CPLV} = -1.5V, 0.5V, 2.25V, 4V, 5.3V$			± 30	
Static Output Current		$V_{CPHV} = 0V$, $V_{CPLV} = -1.5V$, $R_L = 0\Omega$ to $6.5V$	-120		-60	mA
		$V_{CPLV} = 5V$, $V_{CPHV} = 6.5V$, $R_L = 0\Omega$ to $-1.5V$	60		120	
High Clamp Resistance		$V_{CPHV} = 0V$, $V_{CPLV} = -1.5V$, $I_{DUT} = -5mA$ and $-15mA$	48		55	Ω
Low Clamp Resistance		$V_{CPHV} = 6.5V$, $V_{CPLV} = 0V$, $I_{DUT} = 5mA$ and $15mA$	48		55	Ω
High Clamp-Resistance Variation		$I_{DUT} = -20mA$ and $-30mA$, $V_{CPHV} = 2.5V$, $V_{CPLV} = -1.5V$ (Note 35)		± 5		Ω
Low Clamp-Resistance Variation		$I_{DUT} = 20mA$ and $30mA$, $V_{CPLV} = 2.5V$, $V_{CPHV} = 6.5V$ (Note 35)		± 5		Ω
Overshoot and Undershoot		(Note 36)		700		mV
PARAMETRIC MEASUREMENT UNIT (PMU)						
DC ELECTRICAL CHARACTERISTICS						
FORCE VOLTAGE ($R_L \geq 10M\Omega$, $V_{IN} = 2.5V$, unless otherwise noted)						
Force-Voltage Output Range (Note 2)	V_{IN}	$I_{DUT} = 0$	-1.5		+6.5	V
		$I_{DUT} = +FSR/2$, range A	-1.5		+4.5	
		$I_{DUT} = +FSR/2$, ranges B–E	-1.5		+6.1	
		$I_{DUT} = -FSR/2$, range A	1.1		6.5	
		$I_{DUT} = -FSR/2$, ranges B–E	-1.1		+6.5	
Force-Voltage Offset Error		$I_{DUT} = 0$	-5		+5	mV
Force-Voltage PSRR		(Note 5)	-5		+5	mV/V
Force-Voltage Load Regulation		$I_{DUT} = +FSR/2$ to $-FSR/2$ using $SENSE_{-}$ input		± 200		μV
Force-Voltage Offset Temperature Coefficient		(Note 37)		± 50		$\mu V/^\circ C$
Force-Voltage Gain Error		$V_{IN} = -1.5V$ to $+6.5V$, nominal gain = +1	-0.1		+0.1	%
Force-Voltage Gain Temperature Coefficient				± 10		ppm/ $^\circ C$
Force-Voltage Linearity Error		$V_{IN} = -1.5V, 0.5V, 2.5V, 4.5V, 6.5V$ (Notes 38, 39)	-0.02		+0.02	%FSR

Electrical Characteristics (continued)

($V_{CC} = 9.75V$, $V_{EE} = -4.75V$, $V_{DD} = 3.3V$, $V_{HHP} = 17.5V$, $V_{DHV} = 3V$, $V_{DLV} = 0V$, $V_{DTV} = 1.5V$, $SC1 = SC0 = 0V$, $V_{CPHV} = 7.2V$, $V_{CPLV} = -2.2V$, $V_{CTV} = 1.4V$, $V_{BV} = 4V$, $V_{DGS} = V_{GND} = 0V$, $V_{CHV} = V_{IVMAX} = 2V$, $V_{CLV} = V_{IVMIN} = 1V$, $V_{COM} = 2.5V$, $V_{LDHV} = 0V$, $V_{LDLV} = 0V$, $V_{IN} = 2.5V$, $V_{VIOS} = 0V$, $V_{IIOS} = 2.5V$, $V_{CLAMPHI} = 5V$, $V_{CLAMPLO} = 0V$, $V_{HH} = 10V$, $CDRP = 0b001$, $RO = 0b1000$, $HYST = 0b000$, $Z_{LOAD} = 50\Omega$, $T_J = +70^\circ C$ to an accuracy of $\pm 15^\circ C$, unless otherwise noted. All temperature coefficients are measured at $T_J = +40^\circ C$ to $+100^\circ C$, unless otherwise noted.) (Note 1)

PARAMETER	SYMBOL	CONDITIONS	MIN	TYP	MAX	UNITS
Force-Voltage Range Switching Glitch		From any two adjacent ranges, $C_{DUT} = 100pF$, $I_{DUT} = (\pm 0.25 \times FSR)$ of lower current range (Note 4)			0.3	V
MEASURE CURRENT (Measured at MEAS₋ in FIMI Mode, $V_{IN} = V_{IIOS} = V_{DUT} = 2.5V$)						
Measure-Current Offset	I_{MOS}	(Note 38)	-1		+1	%FSR
Measure-Current PSRR		$I_{DUT} = 0$ (Note 5)	-0.05		+0.05	%FSR/V
Measure-Current Offset Temperature Coefficient				± 20		ppmFSR/ °C
Measure-Current Gain Error	I_{MGE}	Ranges A, B, C	-1.0		+1.0	%
		Ranges D, E	-1.1		+1.1	
Measure-Current Gain Temperature Coefficient		Ranges B–E		± 20		ppm/°C
		Range A		+100		
Measure-Current Linearity Error (Note 38)	I_{MLER}	Ranges B–E, $I_{DUT} = -FSR/2, -FSR/4, 0, FSR/4, FSR/2$ relative to end points	-0.02		+0.02	%FSR
		Range A, $I_{DUT} = -30mA, -15mA, 0, 15mA, 30mA$, relative to end points	-0.03		+0.03	
		Range A, $I_{DUT} = -FSR/2, -FSR/4, 0, FSR/4, FSR/2$ relative to end points	-0.06		+0.06	
+FSR Measure Output Voltage		$V_{IIOSMIN} = 2V$ (Note 40)		6		V
		$V_{IIOSMAX} = 4V$ (Note 40)		8		
-FSR Measure Output Voltage		$V_{IIOSMIN} = 2V$ (Note 40)		-2		V
		$V_{IIOSMAX} = 4V$ (Note 40)		0		
Rejection of Output Measure Error Due to Common-Mode Sense Voltage	$CMVRLER$	$I_{DUT} = 0$, $V_{IN} = -1.5V$ to $+6.5V$, percent FSR change at MEAS ₋ per volt change at DUT ₋			0.003	%FSR/V
Measure-Current Range (Note 2)		Range E, $R_E = 500k\Omega$	-2		+2	μA
		Range D, $R_D = 50k\Omega$	-20		+20	
		Range C, $R_C = 5k\Omega$	-200		+200	
		Range B, $R_B = 500\Omega$	-2		+2	mA
		Range A, $R_A = 20\Omega$ (Note 41)	-50		+50	
FORCE CURRENT ($V_{DUT} = V_{IN} = V_{IIOS} = 2.5V$, unless otherwise noted)						
Input-Voltage Range For Setting Force Current to +FSR/2		$V_{IIOSMIN} = 2V$		6		V
		$V_{IIOSMAX} = 3.5V$		7.5		
Input-Voltage Range For Setting Force Current to -FSR/2		$V_{IIOSMIN} = 2V$		-2		V
		$V_{IIOSMAX} = 3.5V$		-0.5		
Current-Sense Amplifier Offset Voltage Input		Relative to V_{DGS}	2.0	2.5	3.5	V

Electrical Characteristics (continued)

($V_{CC} = 9.75V$, $V_{EE} = -4.75V$, $V_{DD} = 3.3V$, $V_{HHP} = 17.5V$, $V_{DHV} = 3V$, $V_{DLV} = 0V$, $V_{DTV} = 1.5V$, $SC1 = SC0 = 0V$, $V_{CPHV} = 7.2V$, $V_{CPLV} = -2.2V$, $V_{CTV} = 1.4V$, $V_{BV} = 4V$, $V_{DGS} = V_{GND} = 0V$, $V_{CHV} = V_{IVMAX} = 2V$, $V_{CLV} = V_{IVMIN} = 1V$, $V_{COM} = 2.5V$, $V_{LDHV} = 0V$, $V_{LDLV} = 0V$, $V_{IN} = 2.5V$, $V_{VIOS} = 0V$, $V_{ILOS} = 2.5V$, $V_{CLAMPHI} = 5V$, $V_{CLAMPLO} = 0V$, $V_{HH} = 10V$, $CDRP = 0b001$, $RO = 0b1000$, $HYST = 0b000$, $Z_{LOAD} = 50\Omega$, $T_J = +70^\circ C$ to an accuracy of $\pm 15^\circ C$, unless otherwise noted. All temperature coefficients are measured at $T_J = +40^\circ C$ to $+100^\circ C$, unless otherwise noted.) (Note 1)

PARAMETER	SYMBOL	CONDITIONS	MIN	TYP	MAX	UNITS
Force-Current Offset		(Note 38)	-0.1		+0.1	%FSR
Force-Current Offset PSRR		(Note 5)	-0.2		+0.2	%FSR/V
Force-Current Offset-Temperature Coefficient		(Note 37)		± 20		ppmFSR / $^\circ C$
Force-Current Gain Error		$V_{IN} = -1.5V$ and $6.5V$	-0.1		+0.1	%
Force-Current Gain-Temperature Coefficient		Ranges B–E		± 20		ppm/ $^\circ C$
		Range A		-100		
Force-Current Linearity Error (Notes 38, 39)		Ranges B–E, $V_{IN} = -1.5V, 0.5V, 2.5V, 4.5V, 6.5V$ relative to end points of I_{DUT}	-0.025		+0.025	%FSR
		Range A, $I_{DUT} \pm 30mA$, $V_{IN} = 0V, 1V, 1.3V, 2.5V, 3.7V, 4.9V$ relative to end points of I_{DUT}	-0.03		+0.03	
		Range A, $V_{IN} = -1.5V, 0.5V, 2.5V, 4.5V, 6.5V$ relative to end points of I_{DUT}	-0.06		+0.06	
Rejection of Output Error Due to Common-Mode DUT_ Voltage		Percent of FSR change of the force current per volt change in DUT_, $V_{DUT} = -1.5V$ to $6.5V$			0.007	%FSR/V
Force-Current Range (Note 2)		Range E, $R_E = 500k\Omega$	-2		+2	μA
		Range D, $R_D = 50k\Omega$	-20		+20	
		Range C, $R_C = 5k\Omega$	-200		+200	
		Range B, $R_B = 500\Omega$	-2		+2	mA
		Range A, $R_A = 20\Omega$, (Note 41)	-50		+50	
MEASURE VOLTAGE (Measured at MEAS_ in FVMV mode, $V_{VIOS} = 0$, $V_{DUT} = V_{IN} = V_{ILOS} = 2.5V$)						
Measure-Voltage Offset			-25		+25	mV
Measure-Voltage PSRR		(Note 5)	-5		+5	mV/V
Measure-Voltage Offset Temperature Coefficient				± 100		$\mu V/^\circ C$
Measure-Voltage Gain Error		$V_{DUT} = -1.5V$ and $6.5V$, nominal gain = +1	-1		+1	%
Measure-Voltage Gain-Temperature Coefficient				± 10		ppm/ $^\circ C$
Measure-Voltage Linearity Error		$V_{IN} = -1.5V, 0.5V, 2.5V, 4.5V, 6.5V$ relative to end points. (Note 38)	-0.02		+0.02	%FSR
Measure Output Voltage (Note 42)		For $V_{DUT} = 6.5V$, measure voltage input range = $-1.5V$ to $6.5V$, V_{VIOS} offsets the range at MEAS_			$6.5 + V_{VIOS}$	V
		For $V_{DUT} = -1.5V$			$-1.5 + V_{VIOS}$	
Voltage Sense Amp Offset Voltage Input	V_{IOS}	Relative to DUT ground (Note 42)	0		1.5	V

Electrical Characteristics (continued)

($V_{CC} = 9.75V$, $V_{EE} = -4.75V$, $V_{DD} = 3.3V$, $V_{HHP} = 17.5V$, $V_{DHV} = 3V$, $V_{DLV} = 0V$, $V_{DTV} = 1.5V$, $SC1 = SC0 = 0V$, $V_{CPHV} = 7.2V$, $V_{CPLV} = -2.2V$, $V_{CTV} = 1.4V$, $V_{BV} = 4V$, $V_{DGS} = V_{GND} = 0V$, $V_{CHV} = V_{IVMAX} = 2V$, $V_{CLV} = V_{IVMIN} = 1V$, $V_{COM} = 2.5V$, $V_{LDHV} = 0V$, $V_{LDLV} = 0V$, $V_{IN} = 2.5V$, $V_{VIOS} = 0V$, $V_{IIOS} = 2.5V$, $V_{CLAMPHI} = 5V$, $V_{CLAMPLO} = 0V$, $V_{HH} = 10V$, $CDRP = 0b001$, $RO = 0b1000$, $HYST = 0b000$, $Z_{LOAD} = 50\Omega$, $T_J = +70^\circ C$ to an accuracy of $\pm 15^\circ C$, unless otherwise noted. All temperature coefficients are measured at $T_J = +40^\circ C$ to $+100^\circ C$, unless otherwise noted.) (Note 1)

PARAMETER	SYMBOL	CONDITIONS	MIN	TYP	MAX	UNITS
FORCE OUTPUT						
Short-Circuit Current Limit in FV Mode		Range A, $V_{IN} = -1.5V$, $V_{DUT} = 6.5V$, $CLENABLE = 0$	-100		-55	mA
		Range B, $V_{IN} = -1.5V$, $V_{DUT} = 6.5V$, $CLENABLE = 0$	-8		-3	
		Range A, $V_{IN} = 6.5V$, $V_{DUT} = -1.5V$, $CLENABLE = 0$	55		100	
		Range B, $V_{IN} = 6.5V$, $V_{DUT} = -1.5V$, $CLENABLE = 0$	3		8	
Force-to-Sense Resistor	R_{FS}	(Note 4)		10		k Ω
SENSE INPUT						
Input-Voltage Range		All modes except VHP driver mode	-1.5		+6.5	V
		VHH driver-mode compliance, SENSE open (Note 43)	-1.5		+13.0	
Input Bias Current		$V_{SENSE} = -1.5V$ and $6.5V$, sense input enabled	-5		+5	nA
COMPARATOR INPUTS ($V_{IN} = V_{IIOS} = 2.5V$, $HYSTEN = 0$, unless otherwise noted)						
Input-Voltage Range		Maximum at $V_{IIOS} = 3.4V$, MI mode		+7.4		V
		Minimum at $V_{IIOS} = 2V$, MI mode		-2.2		
FIMV Offset Voltage		$V_{DUT} = 2.5V$ (Note 44)	-5		+5	mV
FVMI Offset Current		$IVMAX = IVMIN = 2.5V$ (Note 44)	-0.1		+0.1	%FSR
Hysteresis		$HYSTEN = 1$, functionally tested in MV mode		± 25	± 50	mV
VOLTAGE CLAMPS (FI mode, $CLENABLE = 1$)						
Clamp Voltage Range		(Note 45)	-1.5		+6.5	V
Linear FI DUT Range		FI loop not influenced when $V_{DUT} 0.5V$ from voltage clamps	$V_{CLAMPLO} + 0.5$		$V_{CLAMPHI} - 0.5$	V
Clamp Voltage Accuracy		$V_{CLAMPHI} = V_{CLAMPLO} = -1.5V, 0V, 1.5V, 2.5V, 4V, 5V, 6.5V$	-20		+20	mV
CURRENT CLAMPS (FV mode, $CLENABLE = 1$)						
Input Control Voltage Range	$V_{CLAMPHI_MAX}$	Clamp current = $I_{CLAMPHI} = (V_{CLAMPHI} - V_{IIOS})/R_{RANGE}$ (sourcing)		$V_{IIOS} + 1.3V$		V
	$V_{CLAMPLO_MIN}$	Clamp current = $I_{CLAMPLO} = (V_{CLAMPLO} - V_{IIOS})/R_{RANGE}$ (sinking)		$V_{IIOS} - 1.3V$		

Electrical Characteristics (continued)

($V_{CC} = 9.75V$, $V_{EE} = -4.75V$, $V_{DD} = 3.3V$, $V_{HHP} = 17.5V$, $V_{DHV} = 3V$, $V_{DLV} = 0V$, $V_{DTV} = 1.5V$, $SC1 = SC0 = 0V$, $V_{CPHV} = 7.2V$, $V_{CPLV} = -2.2V$, $V_{CTV} = 1.4V$, $V_{BV} = 4V$, $V_{DGS} = V_{GND} = 0V$, $V_{CHV} = V_{IVMAX} = 2V$, $V_{CLV} = V_{IVMIN} = 1V$, $V_{COM} = 2.5V$, $V_{LDHV} = 0V$, $V_{LDLV} = 0V$, $V_{IN} = 2.5V$, $V_{VIOS} = 0V$, $V_{IIOS} = 2.5V$, $V_{CLAMPHI} = 5V$, $V_{CLAMPLO} = 0V$, $V_{HH} = 10V$, $CDRP = 0b001$, $RO = 0b1000$, $HYST = 0b000$, $Z_{LOAD} = 50\Omega$, $T_J = +70^\circ C$ to an accuracy of $\pm 15^\circ C$, unless otherwise noted. All temperature coefficients are measured at $T_J = +40^\circ C$ to $+100^\circ C$, unless otherwise noted.) (Note 1)

PARAMETER	SYMBOL	CONDITIONS	MIN	TYP	MAX	UNITS
CLAMP CURRENT RANGE (NOTE 45)		Range E, $R_E = 500k\Omega$	-2.2		+2.2	μA
		Range D, $R_D = 50k\Omega$	-22		+22	
		Range C, $R_C = 5k\Omega$	-220		+220	
		Range B, $R_B = 500\Omega$	-2.2		+2.2	mA
		Range A, $R_A = 20\Omega$	-55		+55	
LINEAR FV I_{DUT_RANGE}		FV loop not influenced when $I_{DUT_} \geq 10\%$ FSR from current clamps	$I_{CLAMPLO_} + 10\%FSR$		$I_{CLAMPHI_} - 10\%FSR$	A
CLAMP CURRENT ACCURACY		$ I_{CLAMPHI_} = I_{CLAMPLO_} = 0$, (0.25 x FSR), (0.50 x FSR) and (0.55 x FSR), calibrated at 0 and (0.50 x FSR)	-0.5		+0.5	%FSR
COMPARATOR OUTPUTS (Note 46)						
OUTPUT HIGH VOLTAGE		$R_{PULLUP} = 1k\Omega$ to V_{DD}	$V_{DD} - 0.2$			V
OUTPUT LOW VOLTAGE		$R_{PULLUP} = 1k\Omega$ to V_{DD}	0.4			V
HIGH-IMPEDANCE STATE LEAKAGE CURRENT			± 1			μA
HIGH-IMPEDANCE STATE OUTPUT CAPACITANCE			6			pF
AC ELECTRICAL CHARACTERISTICS ($V_{VIOS} = 0V$, $V_{IIOS} = 2.5V$, $C_{DUT_} = C_{MEAS_} = 100pF$, $R_{DUT_} = 4 \times R_{RANGE}$ to 2.5V, unless otherwise noted; setting times are to 0.1%FSR)						
FORCE VOLTAGE						
Settling Time		$V_{IN_} = -1.5V, 6.5V$	Range E, $R_E = 500k\Omega$	140		μs
			Range D, $R_D = 50k\Omega$	30		
			Range C, $R_C = 5k\Omega$	20	30	
			Range B, $R_B = 500\Omega$	20		
		$V_{IN_} = -1V$ to $+6.5V$	Range A, $R_A = 20\Omega$, $R_{DUT_} = 200\Omega$ to 2.5V (Note 41)	20		
Maximum Stable Load Capacitance			2500		pF	
FORCE VOLTAGE/MEASURE CURRENT						
Settling Time			Range E, $R_E = 500k\Omega$	300		μs
			Range D, $R_D = 50k\Omega$	40		
			Range C, $R_C = 5k\Omega$	20	35	
			Range B, $R_B = 500\Omega$	20		
			Range A, $R_A = 20\Omega$, $R_{DUT_} = 200\Omega$ to 2.5V (Note 41)	20		

Electrical Characteristics (continued)

($V_{CC} = 9.75V$, $V_{EE} = -4.75V$, $V_{DD} = 3.3V$, $V_{HHP} = 17.5V$, $V_{DHV} = 3V$, $V_{DLV} = 0V$, $V_{DTV} = 1.5V$, $SC1 = SC0 = 0V$, $V_{CPHV} = 7.2V$, $V_{CPLV} = -2.2V$, $V_{CTV} = 1.4V$, $V_{BV} = 4V$, $V_{DGS} = V_{GND} = 0V$, $V_{CHV} = V_{IVMAX} = 2V$, $V_{CLV} = V_{IVMIN} = 1V$, $V_{COM} = 2.5V$, $V_{LDHV} = 0V$, $V_{LDLV} = 0V$, $V_{IN} = 2.5V$, $V_{VIOS} = 0V$, $V_{IIOS} = 2.5V$, $V_{CLAMPHI} = 5V$, $V_{CLAMPLO} = 0V$, $V_{HH} = 10V$, $CDRP = 0b001$, $RO = 0b1000$, $HYST = 0b000$, $Z_{LOAD} = 50\Omega$, $T_J = +70^\circ C$ to an accuracy of $\pm 15^\circ C$, unless otherwise noted. All temperature coefficients are measured at $T_J = +40^\circ C$ to $+100^\circ C$, unless otherwise noted.) (Note 1)

PARAMETER	SYMBOL	CONDITIONS	MIN	TYP	MAX	UNITS
Range-Change Switching		In addition to force-voltage and measure-current settling times, range A to range B (Note 47)		20		μs
FORCE CURRENT (Measured at MEAS_ in FIMI Mode)						
Settling Time		$V_{IN} = -1.5V$, $+6.5V$	Range E, $R_E = 500k\Omega$	500		μs
			Range D, $R_D = 50k\Omega$	100		
			Range C, $R_C = 5k\Omega$	25	35	
			Range B, $R_B = 500\Omega$	20		
		$V_{IN} = -1.1V$ to $+4.1V$	Range A, $R_A = 20\Omega$ $R_{DUT} = 200\Omega$ to $2.5V$ (Note 41)	20		
FORCE CURRENT/MEASURE VOLTAGE (Note 48)						
Settling Time		Range E, $R_E = 500k\Omega$		1900		μs
		Range D, $R_D = 50k\Omega$		200		
		Range C, $R_C = 5k\Omega$		30	40	
		Range B, $R_B = 500\Omega$		20		
		Range A, $R_A = 20\Omega$, $R_{DUT} = 200\Omega$ to $2.5V$ (Note 41)		20		
Range-Change Switching		In addition to force-current/measure-voltage settling times, range A to range B. (Note 47)		20		μs
SENSE INPUT TO MEASURE OUTPUT PATH (Note 49)						
Propagation Delay		Measured at 90% of output, SENSE input slew rate $\leq 2V/\mu s$		0.07		μs
MEASURE OUTPUT						
High-Impedance Leakage Current		$V_{MEAS} = -1.5V, 2.5V, 6.5V$	-10		+10	nA
HIZMEASP_ True to High-Impedance Time		$R_{MEAS} = 5k\Omega$ to GND, $V_{SENSE} = 2.5V$, measured from the 50% point of $\overline{HIZMEASP}$ to 90% of output		80		ns
$\overline{HIZMEASP}$ False to Active Time		$R_{MEAS} = 5k\Omega$ to GND, $V_{SENSE} = 2.5V$, measured from the 50% point of $\overline{HIZMEASP}$ to 10% of output		40		ns
Maximum Stable Load Capacitance				1000		pF
FORCE OUTPUT						
\overline{LLEAKP} True to Low-Leak Time		$V_{IN} = 1V$, $R_{DUT} = R_{RANGE}$ to GND, FVMI mode, measured from the 50% point of \overline{LLEAKP} to 90% of output		0.3		μs

Electrical Characteristics (continued)

($V_{CC} = 9.75V$, $V_{EE} = -4.75V$, $V_{DD} = 3.3V$, $V_{HHP} = 17.5V$, $V_{DHV} = 3V$, $V_{DLV} = 0V$, $V_{DTV} = 1.5V$, $SC1 = SC0 = 0V$, $V_{CPHV} = 7.2V$, $V_{CPLV} = -2.2V$, $V_{CTV} = 1.4V$, $V_{BV} = 4V$, $V_{DGS} = V_{GND} = 0V$, $V_{CHV} = V_{IVMAX} = 2V$, $V_{CLV} = V_{IVMIN} = 1V$, $V_{COM} = 2.5V$, $V_{LDHV} = 0V$, $V_{LDLV} = 0V$, $V_{IN} = 2.5V$, $V_{VIOS} = 0V$, $V_{IIOS} = 2.5V$, $V_{CLAMPHI} = 5V$, $V_{CLAMPLO} = 0V$, $V_{HH} = 10V$, $CDRP = 0b001$, $RO = 0b1000$, $HYST = 0b000$, $Z_{LOAD} = 50\Omega$, $T_J = +70^\circ C$ to an accuracy of $\pm 15^\circ C$, unless otherwise noted. All temperature coefficients are measured at $T_J = +40^\circ C$ to $+100^\circ C$, unless otherwise noted.) (Note 1)

PARAMETER	SYMBOL	CONDITIONS	MIN	TYP	MAX	UNITS
LLEAKP_ False to Active Time		$V_{IN} = 1V$, $R_{DUT} = R_{RANGE}$ to GND, FVMI mode, measured from the 50% point of LLEAKP_ to 10% of output		0.3		μs
COMPARATORS ($C_{CMP} = 20pF$, $R_{PULLUP} = 1k\Omega$ to V_{DD})						
Rise Time		20% to 80%		35		ns
Fall Time		80% to 20%		1.5		ns
Disable True to High Impedance		Measured from the 50% point of CS (or LOAD) to 10% of the output		25		ns
Disable False to Active		Measured from the 50% point of CS (or LOAD) to 90% of the output		20		ns
ACTIVE LOAD						
DC CHARACTERISTICS ($V_{VCOM} = 2.5V$, $V_{DHV} = V_{DLV} = 6V$, unless otherwise noted)						
VCOM_ Voltage Range	VCOM_		-1.5		+6.5	V
VCOM_ Offset Voltage		$I_{DUT} = 0mA$			± 5	mV
Differential Voltage Range		$V_{DUT} - V_{VCOM}$	-8		+8	V
Offset Voltage-Temperature Coefficient				100		$\mu V/^\circ C$
VCOM_ Voltage Gain		$V_{VCOM} = 0, 4.5V$	0.998	1	1.002	V/V
VCOM_ Voltage-Gain Temperature Coefficient				-10		ppm/ $^\circ C$
VCOM_ Linearity Error		$V_{VCOM} = -1.5V, 0V, 1.5V, 3V, 4.5V, 6.5V$ relative to end points		± 3	± 15	mV
VCOM_ Output-Voltage Power-Supply Rejection Ratio		(Note 5)	40			dB
Sink or Source Output Resistance		$V_{DUT} = 3V, 6.5V$ with $V_{VCOM} = -1.5V$ or $V_{DUT} = -1.5V, 2V$ with $V_{VCOM} = 6.5V$	$I_{SOURCE} = I_{SINK} = 20mA$	30		k Ω
			$I_{SOURCE} = I_{SINK} = 1mA$	250		
Linear Region Output Resistance		$I_{DUT} = \pm 10mA$		12	18	Ω
Dead-Band		$I_{SOURCE} = I_{SINK} = 10mA$, 80% commutation 95% I_{SOURCE} to 95% I_{SINK} , $I_{SOURCE} = I_{SINK} = 20mA$		400		mV
				700	900	

Electrical Characteristics (continued)

($V_{CC} = 9.75V$, $V_{EE} = -4.75V$, $V_{DD} = 3.3V$, $V_{HHP} = 17.5V$, $V_{DHFV} = 3V$, $V_{DLV} = 0V$, $V_{DTV} = 1.5V$, $SC1 = SC0 = 0V$, $V_{CPHV} = 7.2V$, $V_{CPLV} = -2.2V$, $V_{CTV} = 1.4V$, $V_{BV} = 4V$, $V_{DGS} = V_{GND} = 0V$, $V_{CHV} = V_{IVMAX} = 2V$, $V_{CLV} = V_{IVMIN} = 1V$, $V_{COM} = 2.5V$, $V_{LDHV} = 0V$, $V_{LDLV} = 0V$, $V_{IN} = 2.5V$, $V_{VIOS} = 0V$, $V_{IIOS} = 2.5V$, $V_{CLAMPHI} = 5V$, $V_{CLAMPLO} = 0V$, $V_{HH} = 10V$, $CDRP = 0b001$, $RO = 0b1000$, $HYST = 0b000$, $Z_{LOAD} = 50\Omega$, $T_J = +70^\circ C$ to an accuracy of $\pm 15^\circ C$, unless otherwise noted. All temperature coefficients are measured at $T_J = +40^\circ C$ to $+100^\circ C$, unless otherwise noted.) (Note 1)

PARAMETER	SYMBOL	CONDITIONS	MIN	TYP	MAX	UNITS
SOURCE CURRENT ($V_{DUT} = -1V$, $V_{VCOM} = 6V$, $V_{VLDL} = 0V$, $V_{VLDH} = 6V$, unless otherwise noted)						
Source Current Output Range		$V_{VLDH} = 0$ to $6V$ (Note 2)	0		20	mA
Source Current Offset		$V_{VLDH} = 300mV$ (1mA)	-20		+20	μA
Source Current Programming Gain		$V_{VLDH} = 0.3V, 5.4V$ (1mA, 18mA)	3.326	3.333	3.340	mA/V
Source Current Temperature Coefficient				-10		$\mu A/^\circ C$
Source Current Power-Supply Rejection Ratio		(Note 5)			± 60	$\mu A/V$
Source Current Linearity		$V_{VLDH} = 0V, 0.1V, 0.3V, 1.5V, 3V, 5.4V, 6V$, relative to $0.3V$ and $5.4V$			± 80	μA
SINK CURRENT ($V_{DUT} = 6V$, $V_{VCOM} = -1V$, $V_{VLDL} = 6V$, $V_{VLDH} = 0V$, unless otherwise noted)						
Sink Current Output Range		$V_{VLDL} = 0$ to $6V$ (Note 2)	0		20	mA
Sink Current Offset		$V_{VLDL} = 300mV$ (1mA)	-20		+20	μA
Sink Current Programming Gain		$V_{VLDL} = 0.3V, 5.4V$ (1mA, 18mA)	3.326	3.333	3.340	mA/V
Sink Current Temperature Coefficient				10		$\mu A/^\circ C$
Sink Current Power-Supply Rejection Ratio	PSRR	(Note 5)			± 60	$\mu A/V$
Sink Current Linearity		$V_{VLDL} = 0V, 0.1V, 0.3V, 1.5V, 3V, 5.4V, 6V$, relative to $0.3V$ and $5.4V$			± 80	μA
AC CHARACTERISTICS ($Z_L = 50\Omega$ to GND, $V_{VLDH} = V_{VLDL} = 6V$, $TMSEL = LDDIS = LDCAL = 0$)						
Transition Time to/from Inhibit via RCV/NRCV	tEN	Measured from 50% crossing of RCV/NRVC to 10% level of output waveform; $V_{VCOM} = -1.5V$ and $1.5V$		2		ns
Spike During Enable/Disable Transition		$V_{VCOM} = 0V$ (Note 4)		200	300	mV
TEMPERATURE MONITOR						
Nominal Voltage		$T_J = +70^\circ C$, $R_L \geq 10M\Omega$		3.43		V
Temperature Coefficient				10		mV/°C
Output Resistance				15		k Ω
DIGITAL I/O						
DIFFERENTIAL CONTROL INPUTS ($DATA$, $NDATA$, RCV, $NRCV$)						
Input High Voltage			-1.6		+3.5	V
Input Low Voltage			-2.0		+3.1	V
Differential Input Voltage			± 0.15		± 1.0	V

Electrical Characteristics (continued)

($V_{CC} = 9.75V$, $V_{EE} = -4.75V$, $V_{DD} = 3.3V$, $V_{HHP} = 17.5V$, $V_{DHV} = 3V$, $V_{DLV} = 0V$, $V_{DTV} = 1.5V$, $SC1 = SC0 = 0V$, $V_{CPHV} = 7.2V$, $V_{CPLV} = -2.2V$, $V_{CTV} = 1.4V$, $V_{BV} = 4V$, $V_{DGS} = V_{GND} = 0V$, $V_{CHV} = V_{IVMAX} = 2V$, $V_{CLV} = V_{IVMIN} = 1V$, $V_{COM} = 2.5V$, $V_{LDHV} = 0V$, $V_{LDLV} = 0V$, $V_{IN} = 2.5V$, $V_{VIOS} = 0V$, $V_{IIOS} = 2.5V$, $V_{CLAMPHI} = 5V$, $V_{CLAMPLO} = 0V$, $V_{HH} = 10V$, $CDRP = 0b001$, $RO = 0b1000$, $HYST = 0b000$, $Z_{LOAD} = 50\Omega$, $T_J = +70^\circ C$ to an accuracy of $\pm 15^\circ C$, unless otherwise noted. All temperature coefficients are measured at $T_J = +40^\circ C$ to $+100^\circ C$, unless otherwise noted.) (Note 1)

PARAMETER	SYMBOL	CONDITIONS	MIN	TYP	MAX	UNITS
Differential Termination Resistance		Between RCV and NRCV, DATA, and NDATA, tested at $I_{RCV_NRCV} = \pm 4mA$ (Note 50)	96		104	Ω
SINGLE-ENDED CONTROL INPUTS (\overline{CS}, SCLK, DIN, \overline{RST}, \overline{LOAD}, ENVHHP_, LLEAKP_, HIZMEASP_)						
Input High			$2/3 \times V_{DD}$		V_{DD}	V
Input Low			-0.1	$1/3 \times V_{DD}$		V
Input Bias Current			-25		+25	μA
SINGLE-ENDED OUTPUT (DOUT)						
Output High		$I_{OH} = 25\mu A$	$V_{DD} - 0.15$			V
Output Low		$I_{OL} = -25\mu A$		DGND + 0.15		V
SERIAL PORT TIMING						
SCLK Frequency	f				50	MHz
SCLK Pulse-Width High	t_{CH}		8			ns
SCLK Pulse-Width Low	t_{CL}		8			ns
\overline{CS} Low to SCLK High Setup	t_{CSS0}		3.5			ns
SCLK High to \overline{CS} Low Hold	t_{CSH0}		3.5			ns
\overline{CS} High to SCLK High Setup	t_{CSS1}		3.5			ns
SCLK High to \overline{CS} High Hold	t_{CSH1}		3.5			ns
DIN to SCLK High Setup	t_{DS}		3.5			ns
DIN to SCLK High Hold	t_{DH}		3.5			ns
\overline{CS} High Pulse Width	t_{CSWH}		40			ns
\overline{LOAD} Low Pulse Width	t_{LDW}		20			ns
\overline{RST} Low Pulse Width	t_{RST}		20			ns
\overline{CS} High to \overline{LOAD} Low Hold Time	t_{CSHLD}		20			ns
SCLK to DOUT Delay	t_{DO}				40	ns
COMMON FUNCTIONS						
Operating Voltage Range		(Note 2)	-1.5		+13.0	V
DUT_ High-Impedance Leakage		$V_{DUT} = 0V, 1.5V, 3V$	-2		+2	μA
		$V_{CLV} = V_{CHV} = 6.5V, V_{DUT} = -1.5V$	-5		+5	
		$V_{CLV} = V_{CHV} = -1.5V, V_{DUT} = 6.5V$	-5		+5	

Electrical Characteristics (continued)

($V_{CC} = 9.75V$, $V_{EE} = -4.75V$, $V_{DD} = 3.3V$, $V_{HHP} = 17.5V$, $V_{DHV} = 3V$, $V_{DLV} = 0V$, $V_{DTV} = 1.5V$, $SC1 = SC0 = 0V$, $V_{CPHV} = 7.2V$, $V_{CPLV} = -2.2V$, $V_{CTV} = 1.4V$, $V_{BV} = 4V$, $V_{DGS} = V_{GND} = 0V$, $V_{CHV} = V_{IVMAX} = 2V$, $V_{CLV} = V_{IVMIN} = 1V$, $V_{COM} = 2.5V$, $V_{LDHV} = 0V$, $V_{LDLV} = 0V$, $V_{IN} = 2.5V$, $V_{VIOS} = 0V$, $V_{IIOS} = 2.5V$, $V_{CLAMPHI} = 5V$, $V_{CLAMPLO} = 0V$, $V_{HH} = 10V$, $CDRP = 0b001$, $RO = 0b1000$, $HYST = 0b000$, $Z_{LOAD} = 50\Omega$, $T_J = +70^\circ C$ to an accuracy of $\pm 15^\circ C$, unless otherwise noted. All temperature coefficients are measured at $T_J = +40^\circ C$ to $+100^\circ C$, unless otherwise noted.) (Note 1)

PARAMETER	SYMBOL	CONDITIONS	MIN	TYP	MAX	UNITS
DUT_ Low-Leak Mode Leakage		$V_{DUT} = 0V, 1.5V, 3V, T_J < +90^\circ C$	-10		+10	nA
		$V_{CLV} = V_{CHV} = 6.5V, V_{DUT} = -1.5V, T_J < +90^\circ C$	-10		+10	
		$V_{CLV} = V_{CHV} = -1.5V, V_{DUT} = 6.5V, T_J < +90^\circ C$	-10		+10	
DUT_ Combined Capacitance		Driver in terminate mode (Note 4)		3.4	4.3	pF
		Driver in high impedance, PMU in high impedance		8		
Low-Leakage Enable Time		\overline{LLEAKP}_{low} to DUT_ = low leak		20		μs
Low-Leakage Disable Time		\overline{LLEAKP}_{high} to normal operation		20		μs
POWER SUPPLY						
Positive Supply Voltage	V_{CC}		9.5	9.75	10.5	V
Negative Supply Voltage	V_{EE}		-5.2	-4.75	-4.5	V
Logic Supply Voltage	V_{DD}		2.7	3.3	5.0	V
VHHP Supply Voltage	V_{HHP}		17	17.5	18	V
Positive Supply Current	I_{CC}	(Note 51)		120	135	mA
Negative Supply Current	I_{EE}	(Note 51)		245	260	mA
Logic Supply Current	I_{DD}	(Note 51)		4.5	7	mA
VHHP Supply Current	I_H	(Note 51)		1.5	2.0	mA
		VHH mode, no load		45	50	
Power Dissipation per Channel		Includes CTV power at $V_{CTV1} = V_{CTV2} = 1.4V$ (Note 51)		1.2	1.35	W
ANALOG INPUTS						
DUT GROUND SENSE						
Input Range	V_{DGS}	Relative to AGND (Note 52)	-150		+150	mV
Input Bias Current		$V_{DGS} = 0V$	-10		+10	μA
Gain		DHV_, DLV_, DTV_, CPHV_, CPLV_, VHH_	0.985	0.990	1.005	V/V
		All other levels and MEAS_ output	0.995	1.000	1.005	
2.5V REFERENCE						
Nominal Voltage	V_{REF}	(Notes 53, 54)		2.5		V
Input Bias Current			-2		+2	μA
ANALOG BUS ($V_{DUT} = -1.5V$ to $+6.5V$, PMU-F = PMU-S = $-1.5V$ to $+6.5V$, unless otherwise noted)						
PMU-F Switch		$I_{SWITCH} = \pm 2.5mA, V_{DUT} = -1.25V, 2.50V, 6.25V$			100	Ω
PMU-S Switch		$I_{SWITCH} = \pm 100\mu A, V_{DUT} = -1.25V, 2.50V, 6.25V$			2.5	k Ω

Electrical Characteristics (continued)

($V_{CC} = 9.75V$, $V_{EE} = -4.75V$, $V_{DD} = 3.3V$, $V_{HHP} = 17.5V$, $V_{DHV} = 3V$, $V_{DLV} = 0V$, $V_{DTV} = 1.5V$, $SC1 = SC0 = 0V$, $V_{CPHV} = 7.2V$, $V_{CPLV} = -2.2V$, $V_{CTV} = 1.4V$, $V_{BV} = 4V$, $V_{DGS} = V_{GND} = 0V$, $V_{CHV} = V_{IVMAX} = 2V$, $V_{CLV} = V_{IVMIN} = 1V$, $V_{COM} = 2.5V$, $V_{LDHV} = 0V$, $V_{LDLV} = 0V$, $V_{IN} = 2.5V$, $V_{VLOS} = 0V$, $V_{VHOS} = 2.5V$, $V_{CLAMPHI} = 5V$, $V_{CLAMPLO} = 0V$, $V_{HH} = 10V$, $CDRP = 0b001$, $RO = 0b1000$, $HYST = 0b000$, $Z_{LOAD} = 50\Omega$, $T_J = +70^\circ C$ to an accuracy of $\pm 15^\circ C$, unless otherwise noted. All temperature coefficients are measured at $T_J = +40^\circ C$ to $+100^\circ C$, unless otherwise noted.) (Note 1)

PARAMETER	SYMBOL	CONDITIONS	MIN	TYP	MAX	UNITS
PMU-S Switch		$I_{SWITCH} = \pm 10\mu A$, $V_{DUT} = 6.5V$ to $13V$, $V_{PMU-F} = V_{PMU-S} = 6.5V$ to $13V$ for V_{HH} level calibration			5	k Ω
PMU-F Path Current					± 30	mA
PMU-F, PMU-S On-Leakage		F and S Independent, other channel switches off	-10	± 5	+10	nA
PMU-F, PMU-S Off-Leakage			-10	± 1	+10	nA
DIFFERENTIAL COMPARATOR (DIFFERENTIAL_ = 1)						
DC CHARACTERISTICS ($V_{CLV} = V_{CHV} = 0V$, unless otherwise noted)						
Input-Voltage Range	V_{DUT0} , V_{DUT1}	(Notes 22, 55)	-1.5		+6.5	V
Differential Threshold Voltage Range	CLV, CHV	Levels may be safely programmed beyond this range	-1		+1	V
Differential Input Voltage		(Notes 22, 23)	-8		+8	V
Offset Error		$V_{DUT} = 0V$	-5		+5	mV
Gain		$V_{DUTn} = 0V$, $V_{DUTm} = -1V, 1V$	0.998	1	1.002	V/V
Linearity Error Relative to Straight Line from -1V to +1V		$V_{DUTn} = 0V$, $V_{DUTm} = -1V, -0.5V, 0, 0.5V, 1V$	-5		+5	mV
Hysteresis		HYST0	HYST1	HYST2		mV
		0	0	0	0	
		0	0	1	2	
		0	1	0	4	
		0	1	1	6	
		1	0	0	8	
		1	0	1	10	
		1	1	0	12	
1	1	1	15			
Offset Temperature Coefficient		$V_{DUTn} = 0V$ and $V_{DUTm} = -1V, 1V$ (Note 4)	-150		+150	$\mu V/^\circ C$
DC Power-Supply Rejection Ratio		$V_{DUT} = 1.5V$ (Note 27)	50	66		dB
Common-Mode Rejection Ratio	CMRR	$V_{DUT} = -1.5V$ and $6.5V$, $V_{CLV} = V_{CHV} = 0V$ (Note 25)	50	55		dB
AC CHARACTERISTICS ($V_{CHV} = V_{CLV} = 0V$, driver terminated, unless otherwise noted) (Note 4)						
Minimum Pulse Width		(Note 31)		0.5	0.65	ns
Propagation Delay			0.5	1	1.5	ns
Propagation-Delay Match H/L vs. L/H, Individual Comparator			-25		+25	ps

Electrical Characteristics (continued)

($V_{CC} = 9.75V$, $V_{EE} = -4.75V$, $V_{DD} = 3.3V$, $V_{HHP} = 17.5V$, $V_{DHV} = 3V$, $V_{DLV} = 0V$, $V_{DTV} = 1.5V$, $SC1 = SC0 = 0V$, $V_{CPHV} = 7.2V$, $V_{CPLV} = -2.2V$, $V_{CTV} = 1.4V$, $V_{BV} = 4V$, $V_{DGS} = V_{GND} = 0V$, $V_{CHV} = V_{IVMAX} = 2V$, $V_{CLV} = V_{IVMIN} = 1V$, $V_{COM} = 2.5V$, $V_{LDHV} = 0V$, $V_{LDLV} = 0V$, $V_{IN} = 2.5V$, $V_{VIOS} = 0V$, $V_{IIOS} = 2.5V$, $V_{CLAMPHI} = 5V$, $V_{CLAMPLO} = 0V$, $V_{HH} = 10V$, $CDRP = 0b001$, $RO = 0b1000$, $HYST = 0b000$, $Z_{LOAD} = 50\Omega$, $T_J = +70^\circ C$ to an accuracy of $\pm 15^\circ C$, unless otherwise noted. All temperature coefficients are measured at $T_J = +40^\circ C$ to $+100^\circ C$, unless otherwise noted.) (Note 1)

PARAMETER	SYMBOL	CONDITIONS	MIN	TYP	MAX	UNITS
Change in Propagation Delay vs. Duty Cycle		500mV swing, 250mV overdrive, 2ns to 23ns pulse width, relative to PW = 12.5ns	-45		+45	ps
Propagation Delay vs. Common-Mode Voltage		$V_{SWING} = 200mV$, 100mV overdrive, common-mode voltage = -1.4V to +6.4V (Note 32)			70	psP-P
Propagation-Delay Temperature Coefficient				± 3		ps/ $^\circ C$
Propagation Delay vs. Slew Rate		1V/ns to 6V/ns, relative to 2V/ns			± 50	ps
Cable-Droop Compensation		1V swing, rise/fall time = 500ps	CDRP = 0b000		0	%
			CDRP = 0b111		10	
DRIVER VHH						
DC CHARACTERISTICS						
Output-Voltage Range	VHH		0		13	V
DC Output Current		$V_{HH} = 13V$, $I_{DUT} = 10mA$, $V_{DUT} > 12.25V$	+10			mA
		$V_{HH} = 0V$, $I_{DUT} = -10mA$, $V_{DUT} < 0.75V$			-10	
Current Limit		$V_{HH} = 13V$, $V_{DUT} = 0V$ and $V_{HH} = 0V$, $V_{DUT} = 13V$	± 11		± 25	mA
Offset Voltage		$V_{HH} = 8V$			± 30	mV
Gain		$V_{HH} = 8V, 12V$	0.998	1	1.002	V/V
Linearity Relative to 8V, 12V		$V_{HH} = 7V, 8V, 10V, 12V, 13V$			± 10	mV
Linearity Relative to 2V, 12V		$V_{HH} = 0, 2V, 4V, 8V, 12V, 13V$			± 30	mV
Output Resistance		$I_{DUT} = \pm 2mA$, $V_{HH} = 1V$			75	Ω
Output-Voltage Temperature Coefficient		$V_{HH} = 7V$ to $13V$ (Note 4)		± 75	± 500	$\mu V/^\circ C$
AC CHARACTERISTICS ($R_L \geq 10M\Omega$, $C_{DUT} = 100pF$)						
VHH Rise/Fall Times		$V_{DHV} = 3V$, $V_{HH} = 13V$, 10% to 90%			170	ns
VHH Overshoot (Note 4)		$V_{DHV} = 3V$ to $V_{HH} = 13V$ rise			150	mV
		$V_{HH} = 13V$ to $V_{DHV} = 3V$ fall			200	
LEVEL DACs						
Settling Time		Full-scale transition to within 5mV		20		μs
Differential Nonlinearity		$I_{SOURCE} (V_{LDH})$, $I_{SINK} (V_{LDL})$			± 3.5	μA
		V_{HH} , IIOS			± 2	mV
		All other levels			± 1	mV

Electrical Characteristics (continued)

($V_{CC} = 9.75V$, $V_{EE} = -4.75V$, $V_{DD} = 3.3V$, $V_{HHP} = 17.5V$, $V_{DHFV} = 3V$, $V_{DLV} = 0V$, $V_{DTV} = 1.5V$, $SC1 = SC0 = 0V$, $V_{CPHV} = 7.2V$, $V_{CPLV} = -2.2V$, $V_{CTV} = 1.4V$, $V_{BV} = 4V$, $V_{DGS} = V_{GND} = 0V$, $V_{CHV} = V_{IVMAX} = 2V$, $V_{CLV} = V_{IVMIN} = 1V$, $V_{COM} = 2.5V$, $V_{LDHFV} = 0V$, $V_{LDLV} = 0V$, $V_{IN} = 2.5V$, $V_{VIOS} = 0V$, $V_{IIOS} = 2.5V$, $V_{CLAMPHI} = 5V$, $V_{CLAMPLO} = 0V$, $V_{HH} = 10V$, $CDRP = 0b001$, $RO = 0b1000$, $HYST = 0b000$, $Z_{LOAD} = 50\Omega$, $T_J = +70^\circ C$ to an accuracy of $\pm 15^\circ C$, unless otherwise noted. All temperature coefficients are measured at $T_J = +40^\circ C$ to $+100^\circ C$, unless otherwise noted.) (Note 1)

- Note 1:** Unless otherwise specified, all minimum and maximum specifications are production tested. All other specification test limits are guaranteed by design. All tests are performed at nominal supply voltages and after gain and offset calibration, unless otherwise specified.
- Note 2:** Guaranteed by the associated linearity test.
- Note 3:** Change in offset at any voltage over the operating range. Specification includes both gain and offset temperature effects. Limits have been simulated over the entire operating range and verified at worst-case conditions ($V_{DHFV} - V_{DLV} > 200mV$).
- Note 4:** Guaranteed by design and characterization.
- Note 5:** V_{CC} and V_{EE} independently varied over their full range.
- Note 6:** $DATA_ = 1V$, $V_{DHFV} = 3V$, $V_{DLV} = 0V$, $V_{DTV} = 1.5V$, $I_{OUT} = \pm 30mA$. Different values within the range of 48Ω to 52Ω are available by custom trimming (contact factory).
- Note 7:** Resistance measurements are made using $\pm 2.5mA$ current changes in the loading instrument about the noted value. Absolute value of the difference in measured resistance at the specified points, tested separately for each current polarity.
- Note 8:** Rise time, unless otherwise specified for the differential inputs $DATA_$ and $RCV_$, is $250ps$ (10% to 90%) at $40MHz$. (These conditions are for bench characterization. Final test conditions may differ from bench.)
- Note 9:** $\pm 8V$ step into AC-coupled 10Ω load. Current supplied for a minimum of $10ns$. Guaranteed by design to be greater than or equal to DC drive current.
- Note 10:** $V_{DTV} = 1.5V$, $R_S = 50\Omega$. External signal driven into a transmission line to produce a 0 to $3V$ edge at the comparator input with a $600ps$ rise time (10% to 90%). Measurement point is at the comparator input.
- Note 11:** Measured between the 90% point of the driver output (relative to its final value) and the waveform settling to within the specified limit.
- Note 12:** Propagation delays are measured from the crossing point of the differential input signals to the 50% point of expected output swing.
- Note 13:** Average of two measurements for propagation-delay match, t_{LH} vs. t_{HL} .
- Note 14:** Four measurements are made: $DHFV_$ to high impedance, $DLV_$ to high impedance, high impedance to $DHFV_$, and high impedance to $DLV_$. The worst of the four measurements is reported.
- Note 15:** Average of four measurements of propagation-delay match, drive to high impedance vs. high impedance to drive. Measured from the crossing point of $RCV/NRCV$ to the 50% point of the output waveform.
- Note 16:** Average of four measurements for propagation-delay match, drive to term vs. term to drive. Measured from the crossing point of $RCV/NRCV$ to the 50% point of the output waveform.
- Note 17:** Four measurements are made: $DHFV_$ to $DTV_$, $DLV_$ to $DTV_$, $DTV_$ to $DHFV_$, and $DTV_$ to $DLV_$. The worst-case difference is reported.
- Note 18:** Propagation-delay change is reported with respect to a $5ns$ pulse width.
- Note 19:** At this pulse width, the output reaches at least 95% of its nominal (DC) amplitude. The pulse width is measured at $DATA_$ and $NDATA_$.
- Note 20:** Maximum data rate in transitions/second. A waveform that reaches at least 95% of its programmed amplitude may be generated at half of this frequency.
- Note 21:** Maximum data rate in transitions/second. A waveform that reaches at least 90% of its programmed amplitude may be generated at half of this frequency.
- Note 22:** The comparators tolerate the V_{HH} produced by the driver; however, the specifications only apply to the $-1.5V$ to $+6.5V$ input range.
- Note 23:** This specification is implicitly tested, by meeting the high-impedance leakage specification.
- Note 24:** Change in offset at any voltage over operating range. Includes both gain (CMRR) and offset temperature effects.
- Note 25:** Change in offset voltage over the input range.
- Note 26:** Relative to straight line between 0 and $3V$.
- Note 27:** Change in offset voltage with power supplies independently varied over their full range. Both high and low comparators are tested.
- Note 28:** All propagation delays measured from $V_{DUT_}$ crossing calibrated $CHV_/CLV_$ threshold to crossing point of differential outputs.

Electrical Characteristics (continued)

($V_{CC} = 9.75V$, $V_{EE} = -4.75V$, $V_{DD} = 3.3V$, $V_{HHP} = 17.5V$, $V_{DHFV} = 3V$, $V_{DLV} = 0V$, $V_{DTV} = 1.5V$, $SC1 = SC0 = 0V$, $V_{CPHV} = 7.2V$, $V_{CPLV} = -2.2V$, $V_{CTV} = 1.4V$, $V_{BV} = 4V$, $V_{DGS} = V_{GND} = 0V$, $V_{CHV} = V_{IVMAX} = 2V$, $V_{CLV} = V_{IVMIN} = 1V$, $V_{COM} = 2.5V$, $V_{LDHV} = 0V$, $V_{LDLV} = 0V$, $V_{IN} = 2.5V$, $V_{VIOS} = 0V$, $V_{IIOS} = 2.5V$, $V_{CLAMPHI} = 5V$, $V_{CLAMPLO} = 0V$, $V_{HH} = 10V$, $CDRP = 0b001$, $RO = 0b1000$, $HYST = 0b000$, $Z_{LOAD} = 50\Omega$, $T_J = +70^\circ C$ to an accuracy of $\pm 15^\circ C$, unless otherwise noted. All temperature coefficients are measured at $T_J = +40^\circ C$ to $+100^\circ C$, unless otherwise noted.) (Note 1)

Note 29: All delay specifications are measured with DUT_{-} (comparator input) as the reference.

Note 30: 40MHz, 0 to 1V input to comparator, reference = 0.5V, 50% duty cycle, 250ps rise/fall time, $Z_S = 50\Omega$, driver in term mode with $V_{DTV} = 0V$, and hysteresis disabled, unless otherwise specified.

Note 31: At this pulse width, the output reaches at least 90% of its nominal peak-to-peak swing. The pulse width is measured at the crossing points of the differential outputs. 250ps rise/fall time at DUT_{-} . Timing dispersion specifications are not guaranteed.

Note 32: $V_{DUT_{-}} = 200mV_{P-P}$, rise/fall time = 150ps, overdrive = 100mV, $V_{DTV} = V_{CM}$. Valid for common-mode ranges where the signal does not exceed the operating range. Specification is worst case (slowest-fastest) over the specified range.

Note 33: For any input slew rate up to 6V/ns, no unusual behavior should be exhibited (i.e., glitching, changing polarity, etc.).

Note 34: Input to comparator is 40MHz at 0 to 1V, 50% duty cycle, 250ps 10% to 90% rise time. EQ bandwidth = $0.22/(t_{TCMP}^2 + t_{TINPUT}^2)^{1/2}$ where t_{TINPUT} and t_{TCMP} are the 20% to 80% transition time of the comparator input and reconstructed output.

Note 35: Resistance measurements are made using $\pm 2.5mA$ current changes in the loading instrument. Value reported is the absolute value of the difference in measured resistance over the specified range, tested separately for each current polarity.

Note 36: Stimulus is 0 to 3V, 2.5V/ns square wave from far end of 3ns transmission line with $R_S = 25\Omega$, clamps set to 0 and 3V.

Note 37: Change in offset over the entire operating range. Includes both gain and offset temperature effects.

Note 38: Interpretation of errors are expressed in terms of %FSR (percent of full-scale range) as a percentage of the end-point-to-end-point range (i.e., for the $\pm 2mA$ range, the full-scale range = 4mA and a 1% error = 40 μA).

Note 39: With clamps enabled, the linear DUT_{-} current range for force voltage is defined by the clamp-current-range specification, and the linear DUT_{-} voltage range for force current is defined by the linear FI $V_{DUT_{-}}$ range specification.

Note 40: For currents greater than +FSR/2, V_{MEAS} is greater than $V_{IIOS} + 4V$ and for currents less than -FSR/2, V_{MEAS} is less than $V_{IIOS} - 4V$.

Note 41: This current is supplied by the driver.

Note 42: V_{VIOS} may be programmed to greater than 1.5V to a maximum value of 2.5V; however, the maximum valid $V_{DUT_{-}}$ value must be reduced below 6.5V, as the maximum MEAS output is limited to 8V. Because $V_{MEAS} = V_{DUT_{-}} + V_{VIOS}$, then $V_{DUT_{-}MAX} = 8V - V_{VIOS}$ when $V_{VIOS} > 1.5V$.

Note 43: Guaranteed by driver $V_{HH_{-}}$ and DLV_{-} linearity tests.

Note 44: $IVMAX$ and $IVMIN$ do not have separate calibration registers for MI and MV modes. Specifications apply with calibration for each mode.

Note 45: Guaranteed by the associated accuracy test.

Note 46: The digital interface is compatible with $2.7V \leq V_{DD} \leq 5V$ CMOS logic.

Note 47: See the *Typical Operating Characteristics* section.

Note 48: FIMV settling times are a function of $C_{DUT_{-}}$ and R_{RANGE} . Increased DUT_{-} capacitance will increase settling time.

Note 49: The propagation delay time is guaranteed only over the force-voltage output range. Propagation delay is measured by holding V_{SENSE} steady and transitioning $IVMAX_{-}$ or $IVMIN_{-}$.

Note 50: Default configuration has internal 100 Ω resistors between DATA and NDATA, RCV and NRCV. Resistor terminations from DATA, NDATA, RCV, and NRCV to a separate pin are available by special request.

Note 51: At nominal supply voltages. Total current for dual device. $R_L \geq 10M\Omega$.

Note 52: Increasing DGS beyond 0V requires a proportional increase in the minimum supply levels. Specified ranges for all DAC output levels are defined with respect to DGS.

Note 53: The error of the external 2.5V reference impacts the accuracy of the DAC levels; a 1% error in the 2.5V reference will translate to a 1% error in the DAC level gain. Use a precision voltage reference, such as the MAX6225.

Note 54: Generate the 2.5V external reference with respect to DGS (DUT ground sense).

Note 55: Guaranteed by associated $CMRR_{-}$ test.

Note 56: The comparator outputs are normally source side-terminated with 50 Ω on-die to CTV_{-} and at the receive side of the transmission path. The comparator outputs are tested with the 50 Ω on-die source resistors only with limits relative to CTV_{-} twice the values indicated.

Typical Operating Characteristics

($V_{CC} = 9.75V$, $V_{EE} = -4.75V$, $V_{DD} = 3.3V$, $V_{HHP} = 17.5V$, $V_{DHV_} = 3V$, $V_{DLV_} = 0V$, $V_{DTV_} = 1.5V$, $SC1 = SC0 = 0$, $V_{CPHV_} = 7.2V$, $V_{CPLV_} = -2.2V$, $R_T = 50\Omega \parallel 1pF$, $C_L = 100pF$, $CTV_ = 1.4V$, $T_J = +70^\circ C$, unless otherwise specified. All temperature coefficients are measured at $T_J = +40^\circ C$ to $+100^\circ C$.)

DRIVER SMALL-SIGNAL RESPONSE

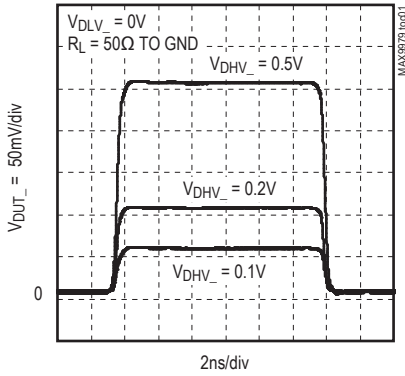

DRIVER LARGE-SIGNAL RESPONSE

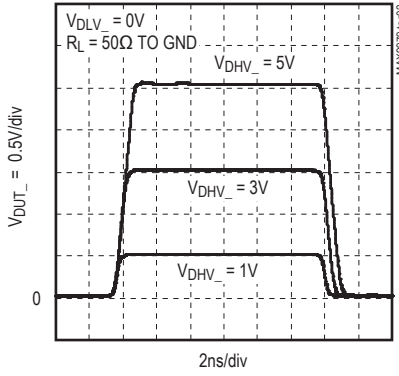

DRIVER TRAILING-EDGE TIMING ERROR vs. PULSE WIDTH

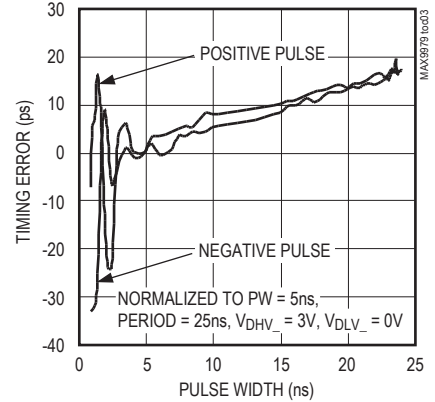

DRIVER TIME DELAY vs. COMMON-MODE VOLTAGE

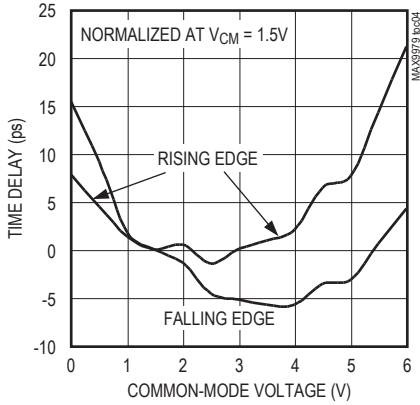

DRIVER-TO-TERM TRANSITION

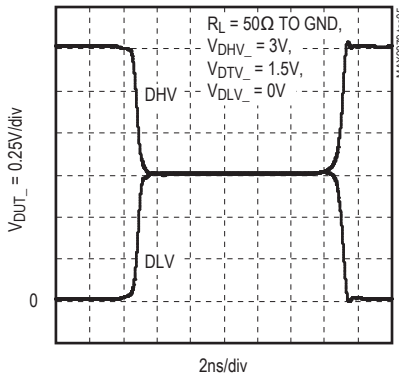

DRIVER TO HIGH-IMPEDANCE TRANSITION

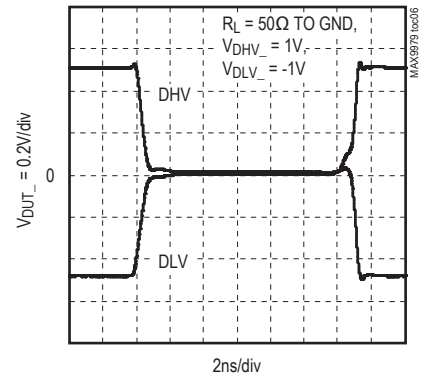

DRIVER LINEARITY ERROR vs. OUTPUT VOLTAGE

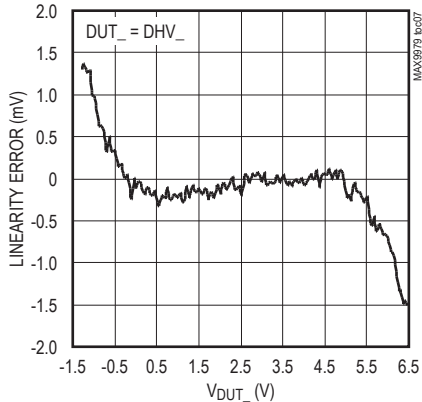

DRIVER LINEARITY ERROR vs. OUTPUT VOLTAGE

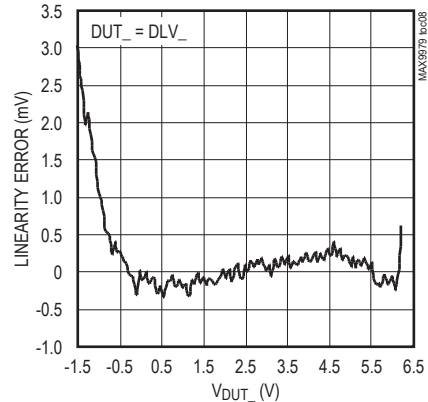

Typical Operating Characteristics (continued)

($V_{CC} = 9.75V$, $V_{EE} = -4.75V$, $V_{DD} = 3.3V$, $V_{HHP} = 17.5V$, $V_{DHV_} = 5V$, $V_{DLV_} = 0V$, $V_{DTV_} = 1.5V$, $SC1 = SC0 = 0$, $V_{CPHV_} = 7.2V$, $V_{CPLV_} = -2.2V$, $R_T = 50\Omega \parallel 1pF$, $C_L = 100pF$, $CTV_ = 1.4V$, $T_J = +70^\circ C$, unless otherwise specified. All temperature coefficients are measured at $T_J = +40^\circ C$ to $+100^\circ C$.)

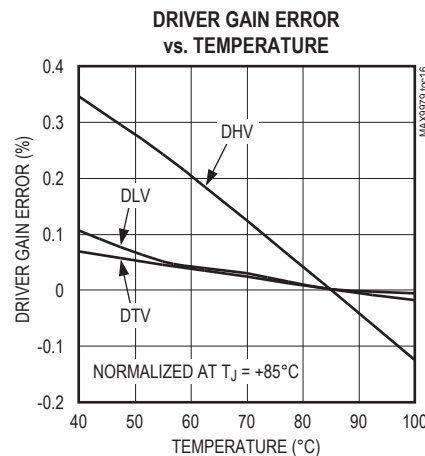
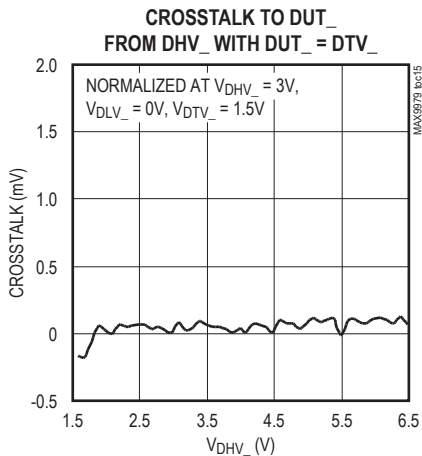
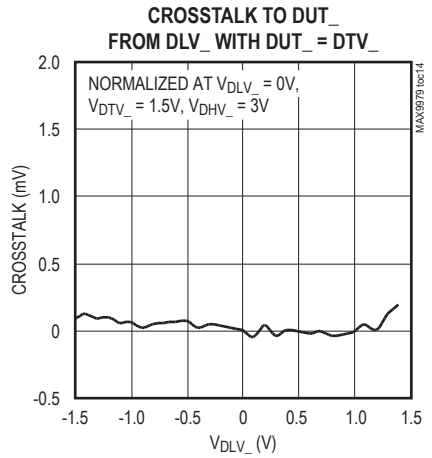
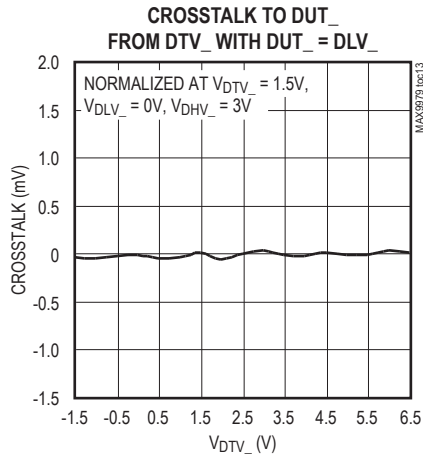
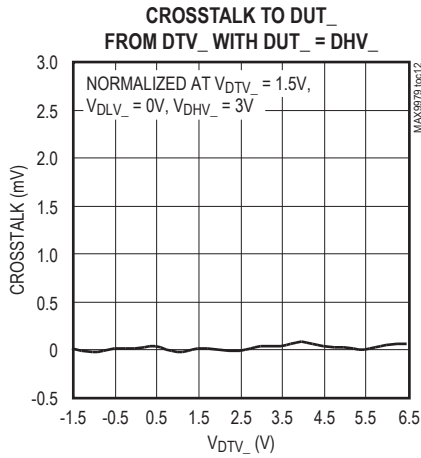
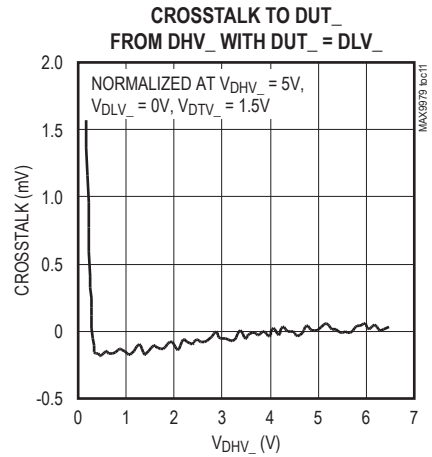
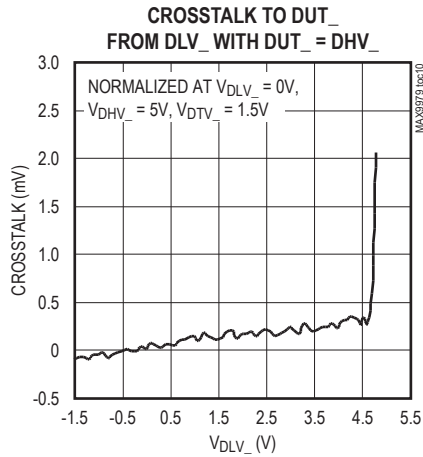
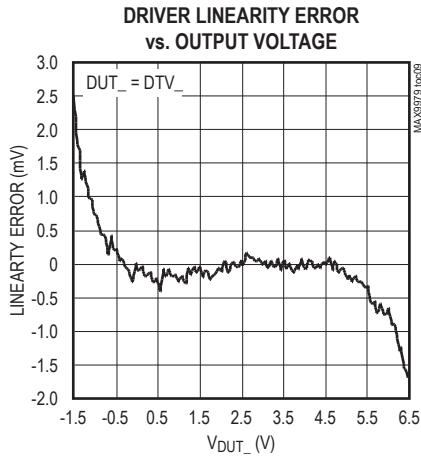

Typical Operating Characteristics (continued)

($V_{CC} = 9.75V$, $V_{EE} = -4.75V$, $V_{DD} = 3.3V$, $V_{HHP} = 17.5V$, $V_{DHV_} = 3V$, $V_{DLV_} = 0V$, $V_{DTV_} = 1.5V$, $SC1 = SC0 = 0$, $V_{CPHV_} = 7.2V$, $V_{CPLV_} = -2.2V$, $R_T = 50\Omega \parallel 1pF$, $C_L = 100pF$, $CTV_ = 1.4V$, $T_J = +70^\circ C$, unless otherwise specified. All temperature coefficients are measured at $T_J = +40^\circ C$ to $+100^\circ C$.)

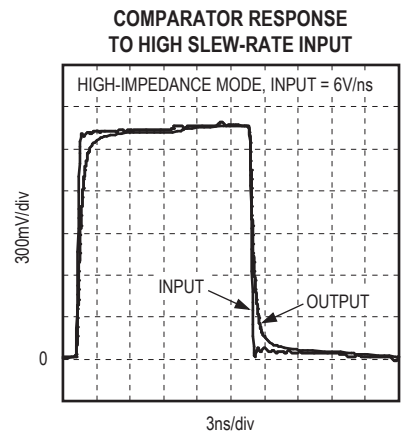
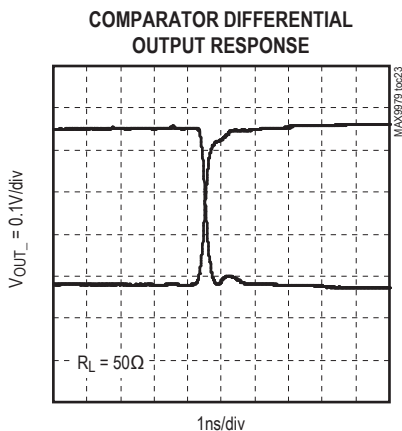
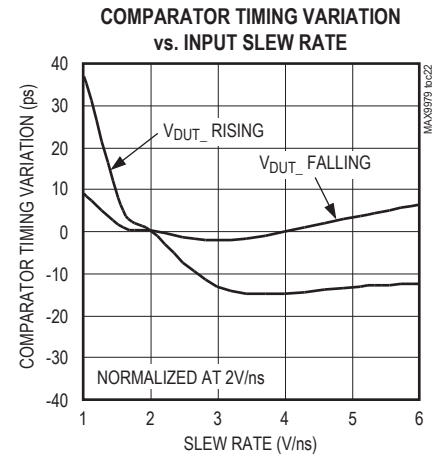
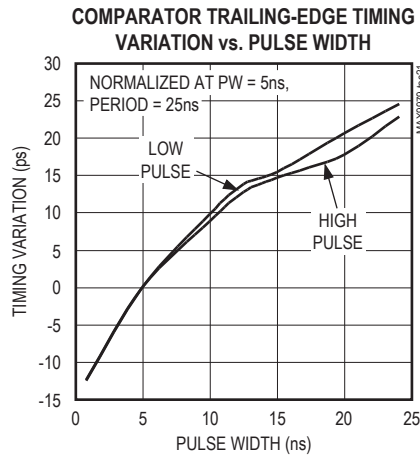
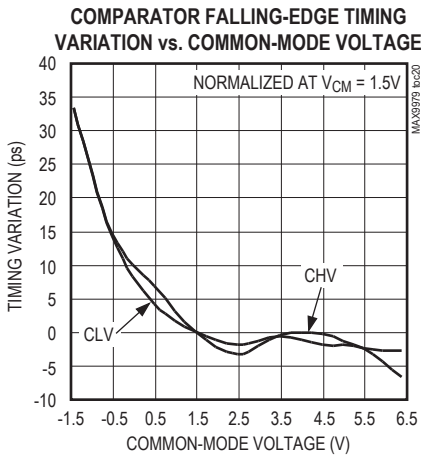
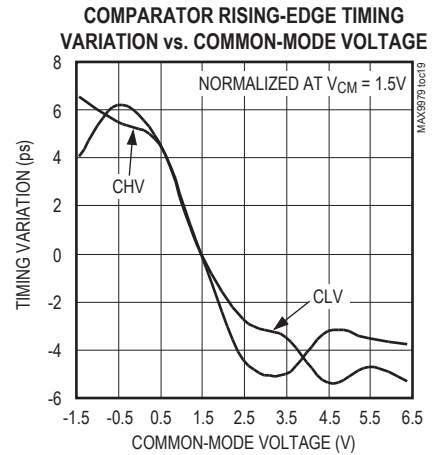
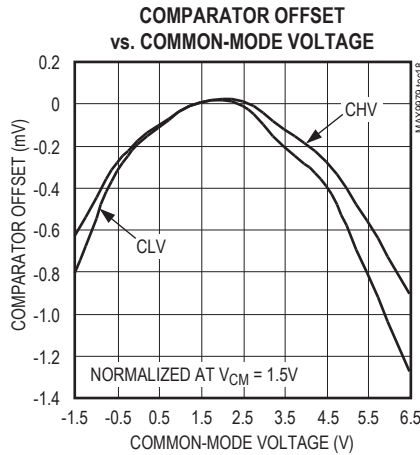
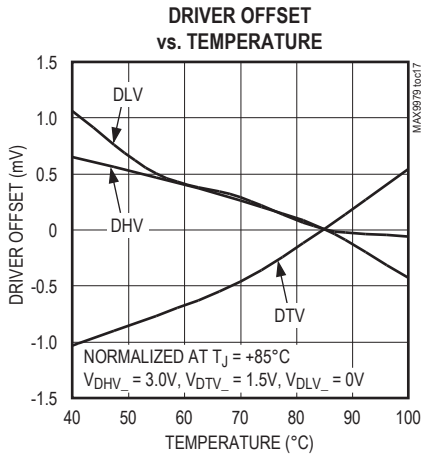

Typical Operating Characteristics (continued)

($V_{CC} = 9.75V$, $V_{EE} = -4.75V$, $V_{DD} = 3.3V$, $V_{HHP} = 17.5V$, $V_{DHV_} = 3V$, $V_{DLV_} = 0V$, $V_{DTV_} = 1.5V$, $SC1 = SC0 = 0$, $V_{CPHV_} = 7.2V$, $V_{CPLV_} = -2.2V$, $R_T = 50\Omega \parallel 1pF$, $C_L = 100pF$, $CTV_ = 1.4V$, $T_J = +70^\circ C$, unless otherwise specified. All temperature coefficients are measured at $T_J = +40^\circ C$ to $+100^\circ C$.)

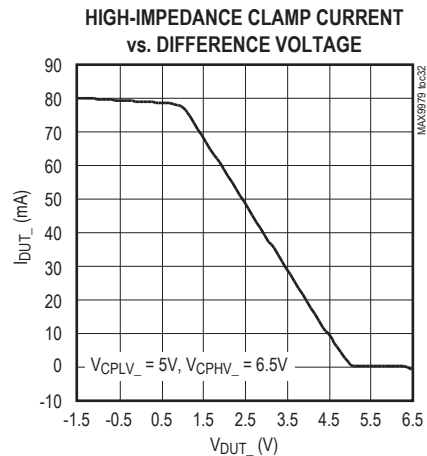
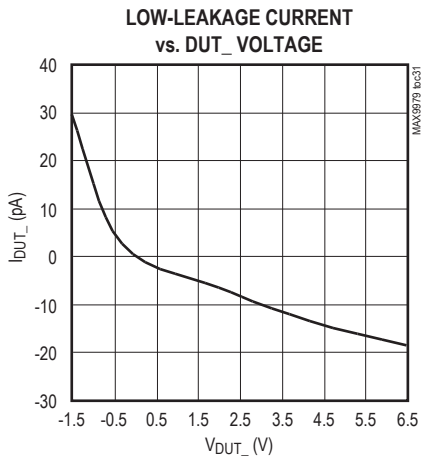
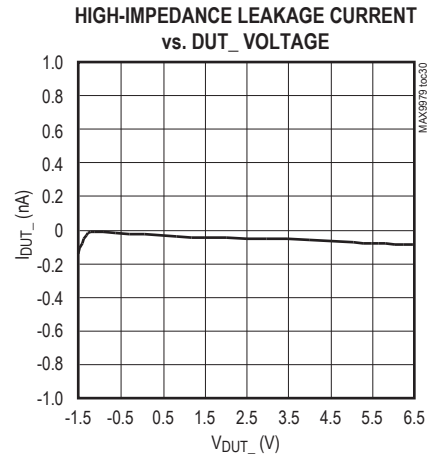
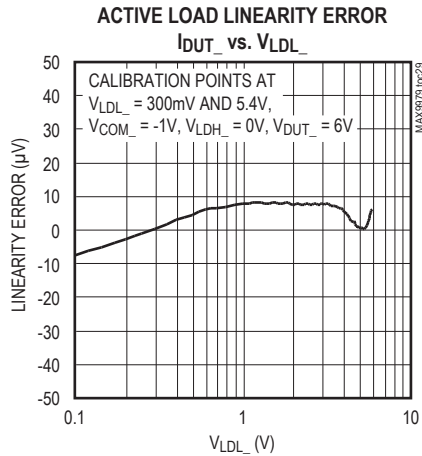
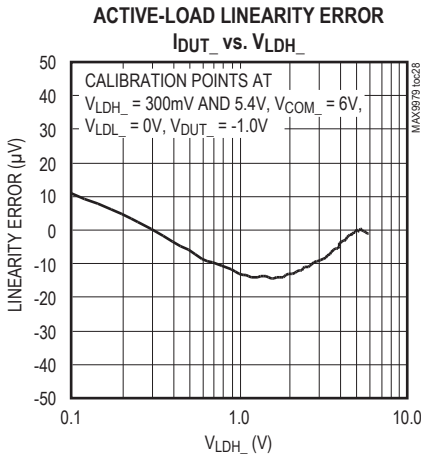
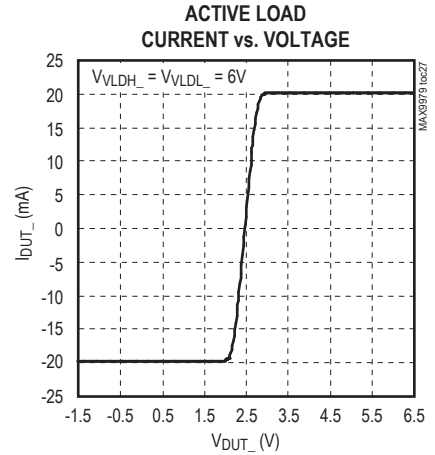
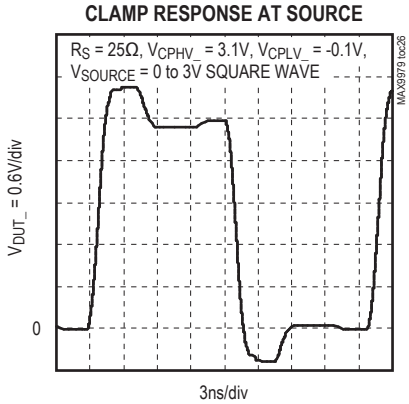
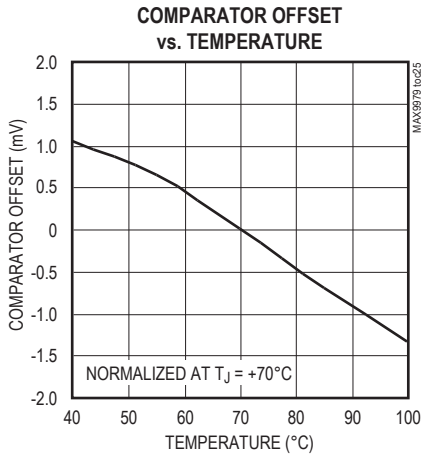

Typical Operating Characteristics (continued)

($V_{CC} = 9.75V$, $V_{EE} = -4.75V$, $V_{DD} = 3.3V$, $V_{HHP} = 17.5V$, $V_{DHV_} = 3V$, $V_{DLV_} = 0V$, $V_{DTV_} = 1.5V$, $SC1 = SC0 = 0$, $V_{CPHV_} = 7.2V$, $V_{CPLV_} = -2.2V$, $R_T = 50\Omega \parallel 1pF$, $C_L = 100pF$, $CTV_ = 1.4V$, $T_J = +70^\circ C$, unless otherwise specified. All temperature coefficients are measured at $T_J = +40^\circ C$ to $+100^\circ C$.)

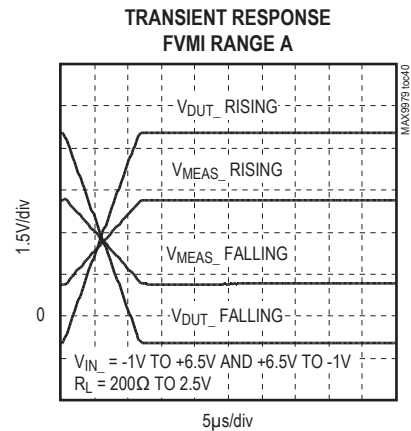
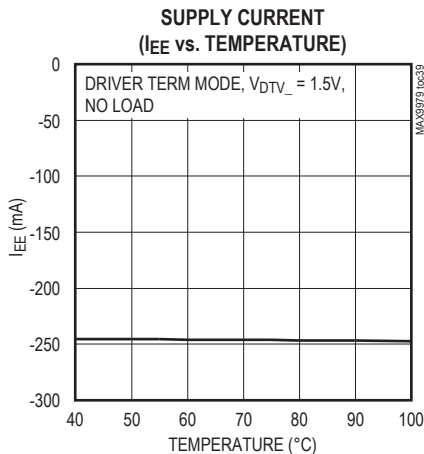
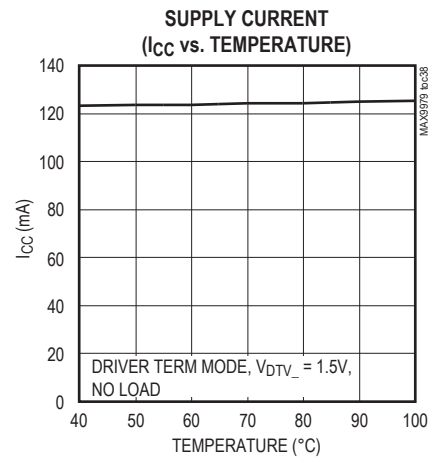
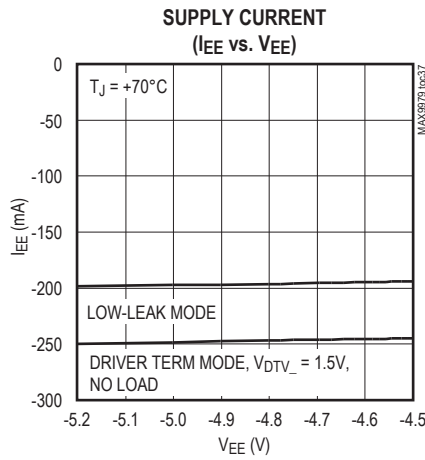
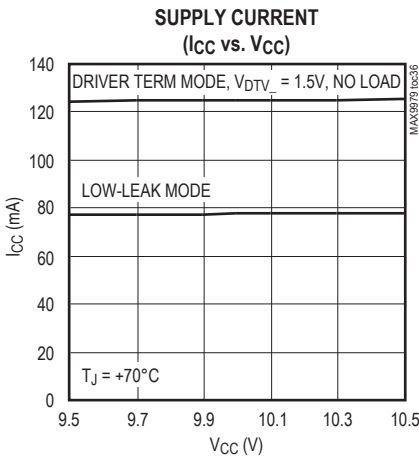
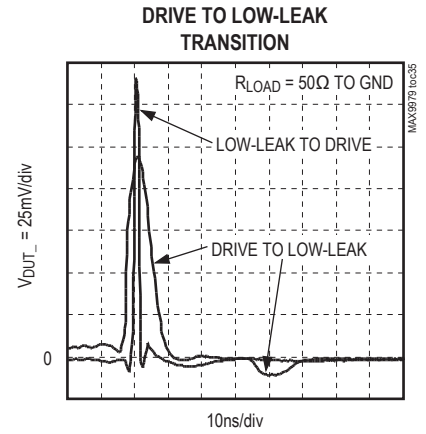
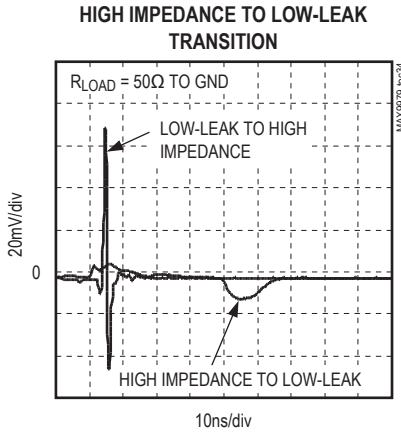
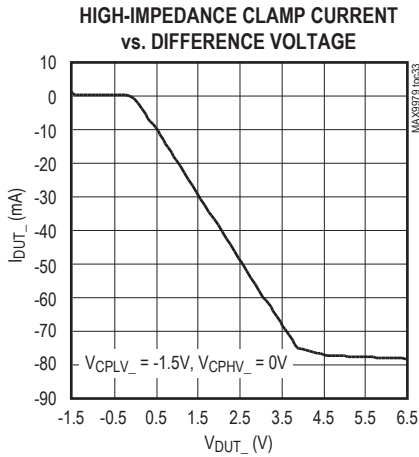

Typical Operating Characteristics (continued)

($V_{CC} = 9.75V$, $V_{EE} = -4.75V$, $V_{DD} = 3.3V$, $V_{HHP} = 17.5V$, $V_{DHV_} = 3V$, $V_{DLV_} = 0V$, $V_{DTV_} = 1.5V$, $SC1 = SC0 = 0$, $V_{CPHV_} = 7.2V$, $V_{CPLV_} = -2.2V$, $R_T = 50\Omega \parallel 1pF$, $C_L = 100pF$, $CTV_ = 1.4V$, $T_J = +70^\circ C$, unless otherwise specified. All temperature coefficients are measured at $T_J = +40^\circ C$ to $+100^\circ C$.)

TRANSIENT RESPONSE
FVMI RANGE B

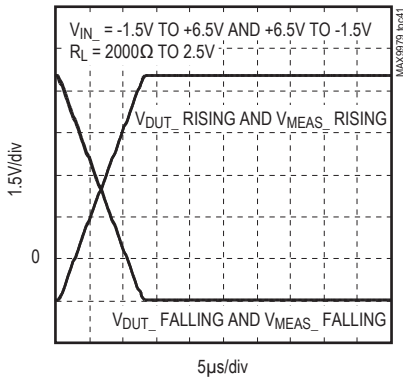

TRANSIENT RESPONSE
FVMI RANGE C

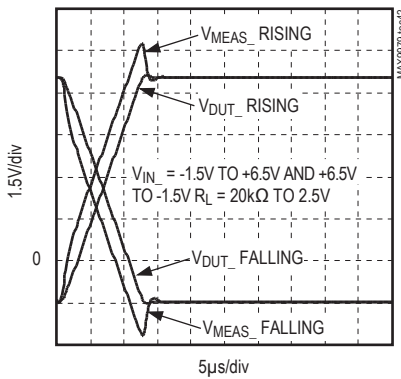

TRANSIENT RESPONSE
FVMI RANGE D

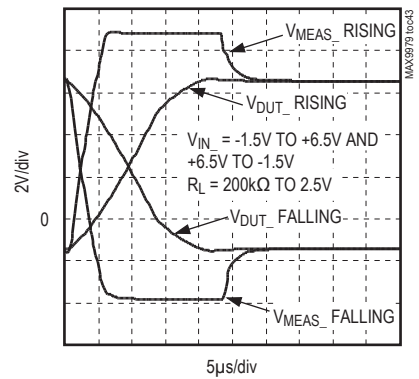

TRANSIENT RESPONSE
FVMI RANGE E

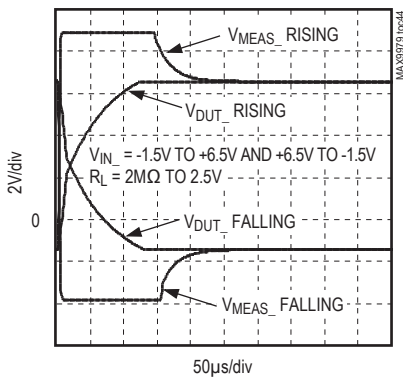

TRANSIENT RESPONSE
FIMI RANGE A

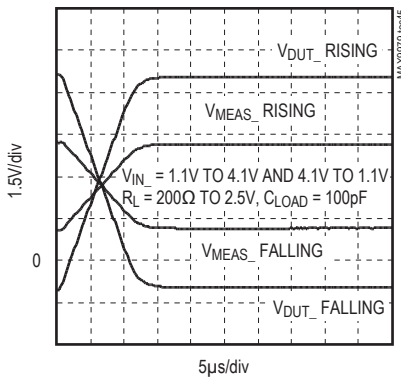

TRANSIENT RESPONSE
FIMI RANGE B

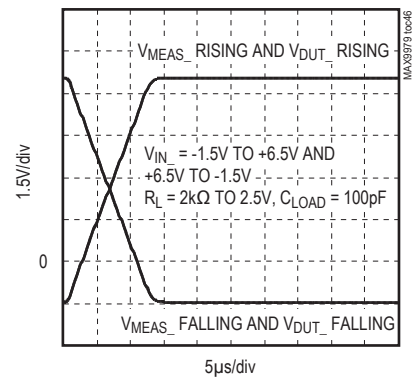

TRANSIENT RESPONSE
FIMI RANGE C

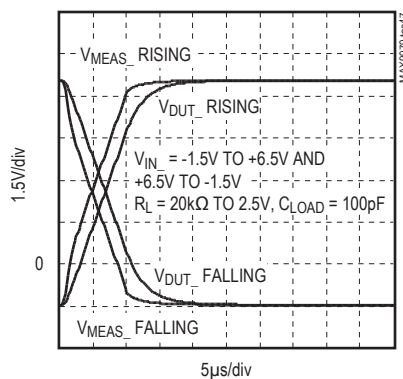

TRANSIENT RESPONSE
FIMI RANGE D

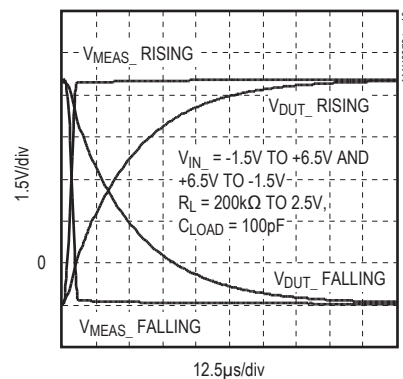

Typical Operating Characteristics (continued)

($V_{CC} = 9.75V$, $V_{EE} = -4.75V$, $V_{DD} = 3.3V$, $V_{HHP} = 17.5V$, $V_{DHY_} = 3V$, $V_{DLV_} = 0V$, $V_{DTV_} = 1.5V$, $SC1 = SC0 = 0$, $V_{CPHV_} = 7.2V$, $V_{CPLV_} = -2.2V$, $R_T = 50\Omega \parallel 1pF$, $C_L = 100pF$, $CTV_ = 1.4V$, $T_J = +70^\circ C$, unless otherwise specified. All temperature coefficients are measured at $T_J = +40^\circ C$ to $+100^\circ C$.)

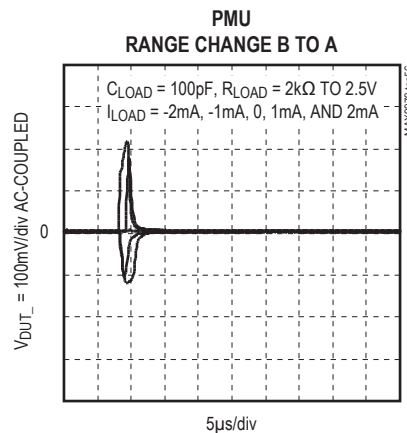
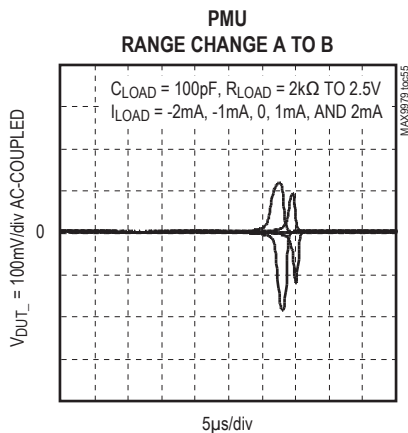
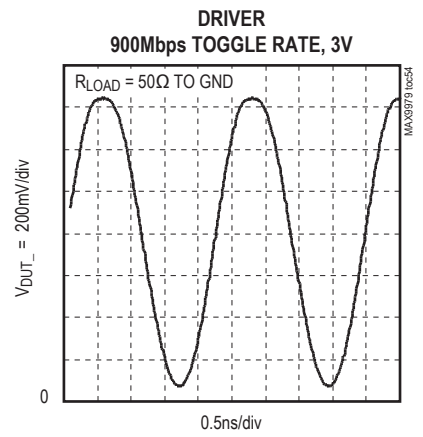
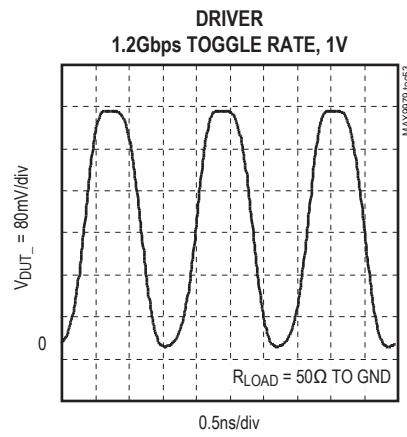
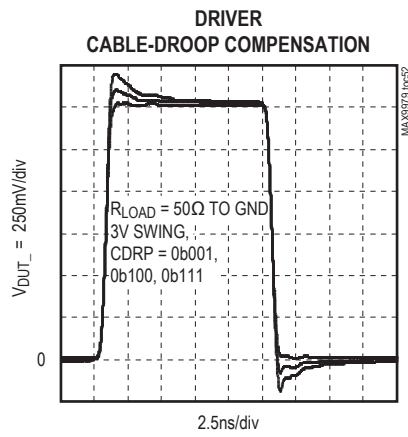
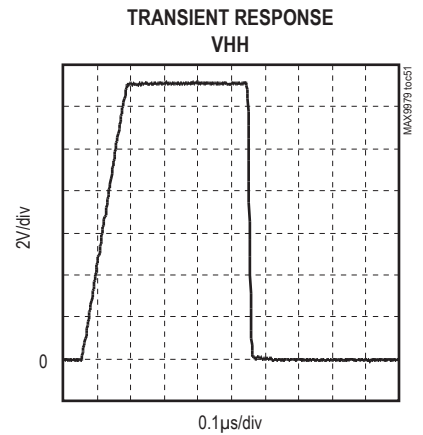
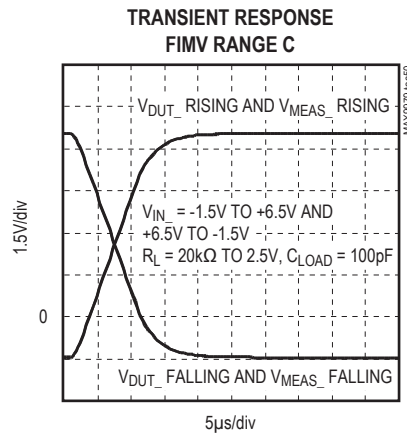
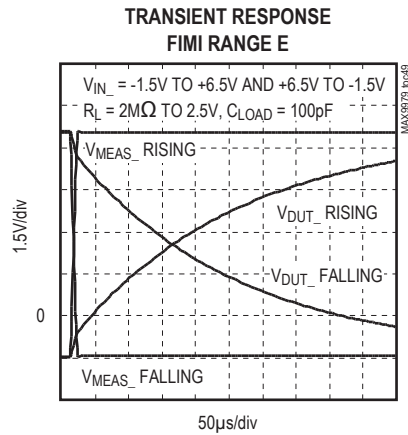

Typical Operating Characteristics (continued)

($V_{CC} = 9.75V$, $V_{EE} = -4.75V$, $V_{DD} = 3.3V$, $V_{HHP} = 17.5V$, $V_{DHV_} = 3V$, $V_{DLV_} = 0V$, $V_{DTV_} = 1.5V$, $SC1 = SC0 = 0$, $V_{CPHV_} = 7.2V$, $V_{CPLV_} = -2.2V$, $R_T = 50\Omega \parallel 1pF$, $C_L = 100pF$, $CTV_ = 1.4V$, $T_J = +70^\circ C$, unless otherwise specified. All temperature coefficients are measured at $T_J = +40^\circ C$ to $+100^\circ C$.)

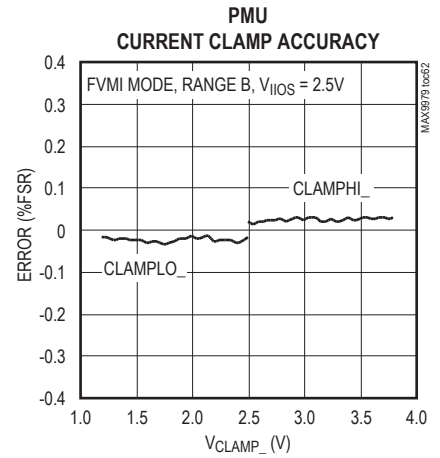
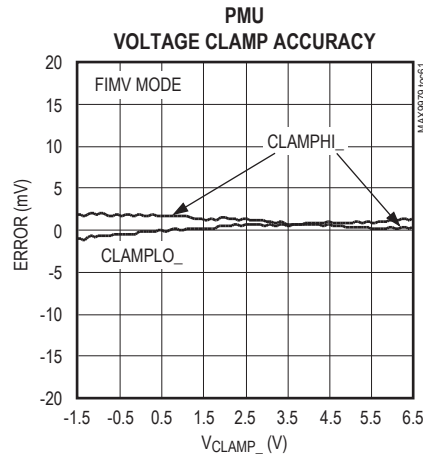
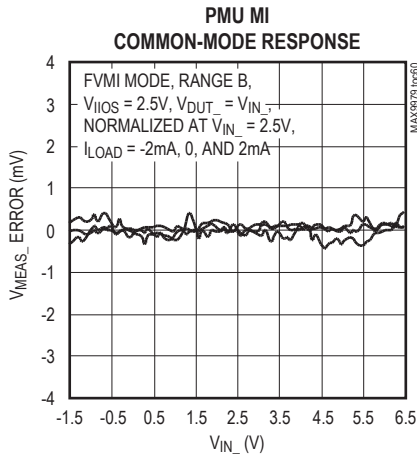
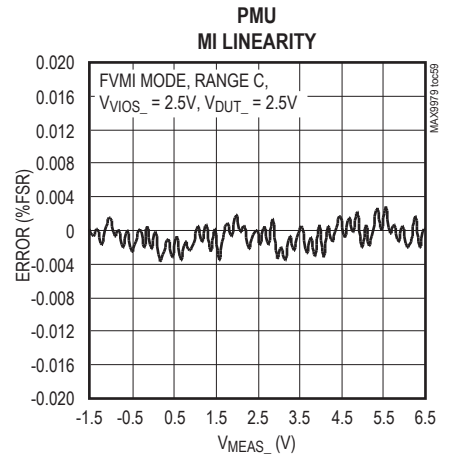
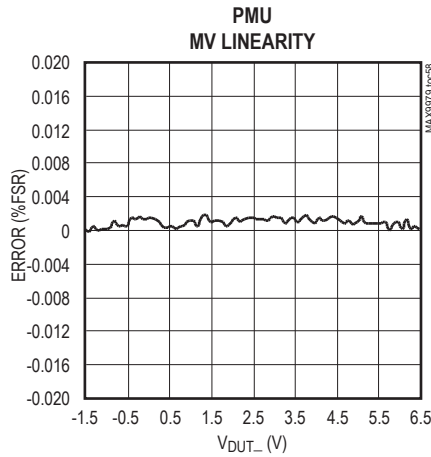
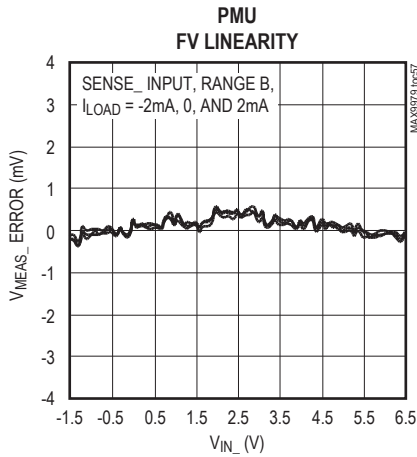

Pin Description

PIN	NAME	DESCRIPTION
1	MEAS0	Channel 0 Measure Output
2	DUTHI0	Channel 0 PMU High Comparator Output
3	DUTLO0	Channel 0 PMU Low Comparator Output
4	REF	DAC Reference Input
5	DGS	DUT Ground Sense Input
6, 35, 51	GND	Analog Ground
7	DOUT	Data Output. Serial-interface data output.
8	DGND	Digital Ground
9	\overline{CS}	Chip-Select Input
10	SCLK	Serial-Clock Input
11	DIN	Data Input. Serial-interface data input.
12	VDD	Digital Power Supply
13	\overline{LOAD}	Load Input. Serial-interface asynchronous load control.
14	\overline{RST}	Reset Input. Serial-interface reset.
15	DUTLO1	Channel 1 PMU Low Comparator Output
16	DUTHI1	Channel 1 PMU High Comparator Output
17	MEAS1	Channel 1 Measure Output
18, 37, 40, 46, 49, 68	VCC	Positive Power Supply
19, 36, 39, 47, 50, 67	VEE	Negative Power Supply
20	HIZMEASP1	Channel 1 High-Impedance Enable Input for PMU Measure Output
21	$\overline{LLEAKP1}$	Channel 1 Low-Leak Enable Input
22	NRCV1	Channel 1 Negative Receive Multiplexer Control Input
23	RCV1	Channel 1 Positive Receive Multiplexer Control Input
24	BV1	Channel 1 Bias Voltage Input
25	NDATA1	Channel 1 Negative Data Multiplexer Control Input
26	DATA1	Channel 1 Positive Data Multiplexer Control Input
27	$\overline{ENVHHP1}$	Channel 1 High-Voltage Mode Enable Input
28	NCL1	Channel 1 Negative Low Comparator Output
29	CL1	Channel 1 Positive Low Comparator Output
30	CTV1	Channel 1 Comparator Termination Voltage
31	NCH1	Channel 1 Negative High Comparator Output
32	CH1	Channel 1 Positive High Comparator Output
33	SENSE1	Channel 1 PMU Sense Input
34, 42, 52	N.C.	No Connection. Not internally connected.
38	DUT1	Channel 1 DUT Connection

Pin Description (continued)

PIN	NAME	DESCRIPTION
41	TEMP	Temperature Output
43	VHHP	High-Voltage Power Supply
44	PMU-F	PMU External Force Connection
45	PMU-S	PMU External Sense Connection
48	DUT0	Channel 0 DUT Connection
53	SENSE0	Channel 0 PMU Sense Input
54	CH0	Channel 0 Positive High Comparator Output
55	NCH0	Channel 0 Negative High Comparator Output
56	CTV0	Channel 0 Comparator Termination Voltage
57	CL0	Channel 0 Positive Low Comparator Output
58	NCL0	Channel 0 Negative Low Comparator Output
59	$\overline{\text{ENVHHP0}}$	Channel 0 High-Voltage Mode Enable Input
60	DATA0	Channel 0 Positive Data Multiplexer Control Input
61	NDATA0	Channel 0 Negative Data Multiplexer Control Input
62	BV0	Channel 0 Bias Voltage Input
63	RCV0	Channel 0 Positive Receive Multiplexer Control Input
64	NRCV0	Channel 0 Negative Receive Multiplexer Control Input
65	$\overline{\text{LLEAKP0}}$	Channel 0 Low-Leak Enable Input
66	$\overline{\text{HIZMEASP0}}$	Channel 0 High-Impedance Enable Input For PMU Measure Output
—	EP	Exposed Pad. Internally connected to ground. Connect to a large open copper PCB plane or heatsink to maximize thermal performance. Not intended as an electrical connection point.

Detailed Description

The MAX9979 dual-channel pin electronics DCL/PMU integrates multiple pin-electronics functions into a single IC. Each channel includes a four-level pin driver, a window comparator, a differential comparator, dynamic clamps, a versatile PMU, an active load, and 14 independent 16-bit level-setting DACs. Additionally, each channel of the MAX9979 features programmable cable-droop compensation for the driver output and for the comparator input, adjustable driver output resistance, and driver slew-rate adjustment.

The MAX9979 driver features a wide -1.5V to +6.5V high-speed operating range, high-impedance and active-termination (3rd-level drive) modes, and is highly linear even at low voltage swings. The MAX9979 also features a built-in super voltage (VHH) level up to 13V. The driver provides high-speed differential control inputs compatible with most high-speed logic families. The window

comparators provide extremely low timing variation over changes in slew rate, pulse width, or overdrive voltage, and have 50Ω source outputs internally terminated to an applied voltage at CTV_. When high-impedance mode is selected, the programmable dynamic clamps provide damping of high-speed DUT waveforms. The 20mA active load facilitates fast contact testing when used in conjunction with the comparators, and functions as a pullup for open-drain/collector DUT outputs. The PMU offers five current ranges from ±2μA to ±50mA and can force and measure current or voltage. Placing the MAX9979 DUT_ output into its very low-leakage state disables the DCL functions and the PMU force function.

This feature is convenient for making IDDQ measurements without the need for an output disconnect relay. Low-leakage control is independent for each channel. An SPI-compatible serial interface and external inputs configure the MAX9979.

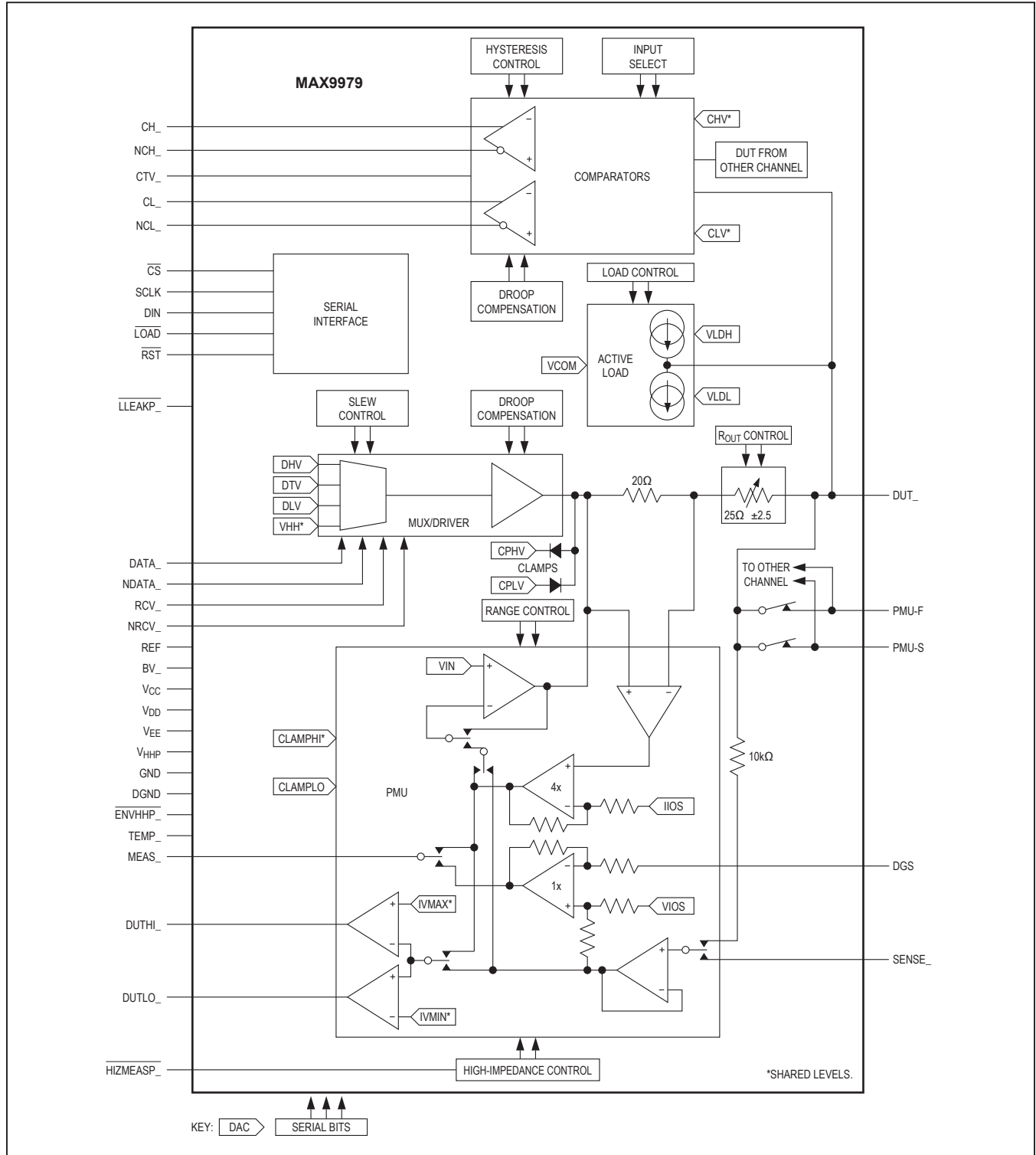

Figure 1. Simplified Block Diagram. Only one of two channels is shown. The PMU is shown in high range. The single serial interface controls both channels.

The integration of DCL and PMU functions in the MAX9979 requires defined states to manage the interaction of these resources. The PMU controls supersede those of the DCL, as described below and shown in Table 1. Important details to keep in mind are:

- Normal high-speed DCL operation is intended only when the PMU is in the FNMN state and the DCL is available, as indicated by Note B in Table 1.
- Forcing $\overline{\text{LLEAKP}}_ = 0$ immediately places the DCL into low-leak mode, and the PMU into its high-impedance state independent of any other programmed control bit or external control inputs. Forcing $\overline{\text{LLEAKP}}_ = 1$ is required to allow any other mode of operation.
- Forcing $\overline{\text{HIZFORCE}}_ = 1$ enables the PMU and simultaneously forces the DCL into low-leak mode.
- Additional PMU settings such as the force and measure modes, current range, the measure output, comparators, and the clamp features are controlled as described later in this document.
- The MAX9979 provides calibration modes under which both the DCL and the PMU are simultaneously active. Forcing $\overline{\text{HIZFORCE}}_ = 0$ ordinarily disables the PMU, however, when $\overline{\text{LLEAKS}}_$ is not asserted, the $\text{FMODE}_$ and $\text{MMODE}_$ bits select these calibra-

tion modes. While in a calibration mode, the DCL states are still selected by the controls normally associated with those functions. When in a calibration mode, the PMU range A is not available. The PMU range defaults to range B if the serial-interface bit $\text{RS2}_ = 1$.

Driver

The driver uses a high-speed multiplexer to select one of three DAC voltages ($\text{DHV}_$, $\text{DLV}_$, and $\text{DTV}_$), or to select high-impedance mode. Multiplexer switching is controlled by high-speed differential inputs $\text{DATA_}/\text{NDATA}_$ and $\text{RCV_}/\text{NRCV}_$ and mode-control bit $\text{TMSEL}_$ (see Table 2). The multiplexer output is buffered to drive $\text{DUT}_$. A programmable slew-rate circuit controls the slew rate of the buffer input.

In high-impedance mode, the clamps and comparators remain connected to $\text{DUT}_$, the $\text{DUT}_$ bias current is less than $\pm 2\mu\text{A}$, and the node continues to track high-speed signals (see Table 2). In low-leakage mode, the bias current at $\text{DUT}_$ is further reduced to less than $\pm 10\text{nA}$, yet signal tracking slows.

The nominal driver output resistance is 50Ω and features an adjustment range of $\pm 2.5\Omega$ through the serial interface in $360\text{m}\Omega$ increments. Contact the factory for different output resistance values.

Table 1. MAX9979 Mode Selection

MODES	DRIVER	COMPARATOR	LOAD	PMU	FMODE_	MMODE_	LLEAKP_	HIZFORCE_	NOTE
PMU	Low leak	Low leak	Low leak	FVMI	0	0	1	1	—
	Low leak	Low leak	Low leak	FVMV	0	1	1	1	—
	Low leak	Low leak	Low leak	FIMI	1	0	1	1	—
	Low leak	Low leak	Low leak	FIMV	1	1	1	1	—
DCL	Low leak	Available	Available	FVMI	0	0	1	0	A
	Available	Available	Available	FIMV	0	1	1	0	A
	Available	Available	Available	FNMN	1	0	1	0	B
	Available	Available	Available	FNMV	1	1	1	0	A
FNMx	Low leak	Low leak	Low leak	FNMN	X	0	0	X	—
	Low leak	Low leak	Low leak	FNMV	X	1	0	X	—

A = Calibration modes.

B = Normal high-speed DCL operation mode.

Table 2. Driver Control

SERIAL-INTERFACE BITS			DIGITAL INPUTS				DRIVER OUTPUT
LLEAKS_	ENVHHS_	TMSEL_	LLEAKP_	ENVHHP_	RCV_	DATA_	
0	X*	X	1	1	0	0	Drive to DLV
0	X*	X	1	1	0	1	Drive to DHV
0	0	0	1	1	1	X	High-impedance receive**
0	0	1	1	1	1	X	Drive to DTV
0	1	X	1	X	1	X	Drive to VHH**
0	0	X	1	0	X	X	Drive to VHH**
X	X	X	0	X	X	X	Low leak
1	X	X	X	X	X	X	Low leak

*Specified DHV, DLV transition times are not altered by the state of ENVHHS_.

**PMU and active load must be disabled to drive to VHH_ and High-impedance mode ($\overline{HIZFORCE}_ = 0, FMODE_ = 1, MMODE_ = 0, LDDIS_ = 1$).

Table 3. Driver Slew Control

SC1_	SC0_	DRIVER SLEW RATE (%)
0	0	100*
0	1	75
1	0	50
1	1	25

*The power-on-reset and \overline{RST} default value.

Driver Slew Control

A slew-rate circuit controls the slew rate of the buffer input. Select one of four possible slew rates according to Table 3. The speed of the internal multiplexer sets the 100% driver slew rate (see the *Driver Large-Signal Response* graph in the *Typical Operating Characteristics* section). SC1 and SC0 are set to 0 at power-up or when \overline{RST} is forced low.

VHH Function

VHH allows DUT_ to drive voltages up to 13V. The VHH_ DAC, which doubles as the PMU's CLAMPHI_ DAC, adjusts from 0 to +13V. Table 2 indicates the control settings required to set DUT_ to VHH_. Table 23 shows the transfer function for the VHH_ DAC.

Driver Cable-Droop Compensation

The driver incorporates active cable-droop compensation. At high frequencies, transmission-line effects from the DUT_ output, across the tester signal delivery path to the device under test, can degrade the output waveform fidelity, resulting in a highly degraded or unusable signal. The compensation circuit counters this degradation by adding a double time-constant decaying waveform to the nominal

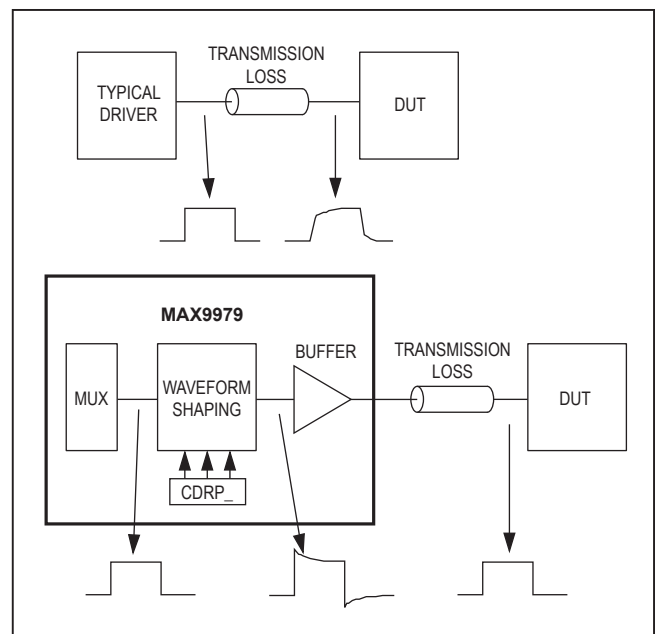

Figure 2. Cable-Droop Compensation

output waveform (pre-emphasis). Figure 2 depicts a comparison between a typical driver and the MAX9979, and shows how droop compensation counters signal degradation. Control bits CDRP0, CDRP1, and CDRP2 vary the amplitude of the compensation signal. Table 4 shows the percent compensation as a function of control bit settings. The power-on-reset and \overline{RST} values for CDRP0, CDRP1, and CDRP2 are 0. The specified default value is CDRP0 = 1 for *Electrical Characteristics* table data.

Table 4. Cable-Droop Compensation Control

SERIAL-INTERFACE BITS			DROOP COMPENSATION (%)
CDRP2_	CDRP1_	CDRP0_	
0	0	0	0*
0	0	1	1.5**
0	1	0	3
0	1	1	4.5
1	0	0	6
1	0	1	7.5
1	1	0	9
1	1	1	10.5

*The power-on-reset and \overline{RST} default value.

**Specified default value for Electrical Characteristics table data.

Adjustable Driver Output Impedance (ΔR_O)

The MAX9979's nominal 50 Ω driver output resistance is adjustable by $\pm 2.5\Omega$ with a 360m Ω resolution. The RO bits in the DCL calibration register set the resistance

value. Table 5 presents the output resistance control logic. The output resistance is set to $R_O + 0.0\Omega$ (0b1000) at power-up or when \overline{RST} is forced low.

Table 5. Output Resistance Control

SERIAL-INTERFACE BITS				DRIVER OUTPUT RESISTANCE (Ω)
RO3_	RO2_	RO1_	RO0_	
0	0	0	0	$R_O - 2.88$
0	0	0	1	$R_O - 2.52$
0	0	1	0	$R_O - 2.16$
0	0	1	1	$R_O - 1.80$
0	1	0	0	$R_O - 1.44$
0	1	0	1	$R_O - 1.08$
0	1	1	0	$R_O - 0.72$
0	1	1	1	$R_O - 0.36$
1	0	0	0	$R_O + 0^*$
1	0	0	1	$R_O + 0.36$
1	0	1	0	$R_O + 0.72$
1	0	1	1	$R_O + 1.08$
1	1	0	0	$R_O + 1.44$
1	1	0	1	$R_O + 1.80$
1	1	1	0	$R_O + 2.16$
1	1	1	1	$R_O + 2.52$

*Power-on-reset and \overline{RST} default value.

Driver DATA Invert Mode

The DATA_/NDATA_ signals for a driver channel are internally inverted when the INVERT_ bit in the DCL register is asserted. The INVERT_ bit is set to 0 at power-up or when $\overline{\text{RST}}$ is forced low.

Driver Differential Data Mode

The MAX9979 allows the drivers to be configured for control of both channels from the channel 0 DATA0/NDATA0 inputs. This feature allows the two channels to drive DUT nodes in parallel, providing a 25Ω driver at twice the nominal drive current. Enable this feature by setting the DIFFERENTIAL0 bit in the DCL register. The DIFFERENTIAL0 bit is set to 0 at power-up or when $\overline{\text{RST}}$ is forced low.

Driver Invert + Differential Data Mode

Combining the differential and the invert modes allows the two channels to produce complementary outputs at DUT0 and DUT1 from a single digital data stream at DATA0/NDATA0. The driver block diagram (Figure 3) shows the logic of the differential and inverted modes.

Bias Voltage Input (BV_)

Apply a voltage to BV_ that is \geq the V_{IH} voltage used for the DATA_ and RCV_ inputs ($V_{IH}(\text{DATA}_, \text{RCV}_) < V_{BV} < 3.5\text{V}$, because there are ESD-protection diodes between BV_ and the high-speed inputs. Failure to do this turns on the protection diodes, degrading the DATA_ and RCV_ signals. Input bias current for BV_ is less than 1μA.

Driver Voltage Clamps

The voltage clamps (high and low) limit the voltage at DUT_ and suppress reflections when the channel is configured as a high-impedance receiver. The clamps behave as diodes connected to the outputs of high-current buffers (Figure 1). Internal circuitry compensates for the diode drop at 1mA clamp current. Set the clamp voltages using the level-setting DACs (CPHV_ and CPLV_). The clamps are enabled only when the driver is in the high-impedance mode. For transient suppression, set the clamp voltages to approximately the minimum and maximum expected DUT_ voltage range. The optimal clamp voltages are application-specific and must be empirically determined.

Set the clamp voltages at least 0.7V outside the expected DUT_ voltage range when not using the clamps. Overvoltage protection then remains active without loading DUT_. Driver clamps are always and only enabled in driver high-impedance mode.

High-Speed Comparators

The MAX9979 provides two independent high-speed comparators for each channel. Each comparator has one input connected internally to DUT_ and the other input connected to either CHV_ or CLV_ (Figure 4). Cable-droop compensation is present on both channels. Comparator outputs are a logical result of the input conditions.

This configuration switches a 16mA current source between the two outputs, and each output has an internal termination resistor connected to CTV_. These resistors are typically 50Ω. Use alternate configurations to terminate different path impedance provided that the absolute maximum ratings are not exceeded. Note that the resistor value also sets the voltage swing. The output provides a nominal 400mV_{P-P} swing with a 50Ω load termination, and a 50Ω source termination. See the *Electrical Characteristics* section titled *High-Speed Comparators, Logic Outputs* for definition of the V_{OH} voltage.

Single-Ended Window Comparator

Set the DIFFERENTIAL1 bit = 0 in the channel 1 DCL register to enable the high-speed window comparator. DAC voltages CHV_ and CLV_ control the comparator thresholds. Table 6 shows the truth table for the comparators. Figure 4 shows the comparator block diagram.

Table 6. Single-Ended Window Comparator Truth Table

CONDITION		CH_	CL_
$V_{DUT_} < V_{CHV_}$	$V_{DUT_} < V_{CLV_}$	0	0
$V_{DUT_} < V_{CHV_}$	$V_{DUT_} > V_{CLV_}$	0	1
$V_{DUT_} > V_{CHV_}$	$V_{DUT_} < V_{CLV_}$	1	0
$V_{DUT_} > V_{CHV_}$	$V_{DUT_} > V_{CLV_}$	1	1

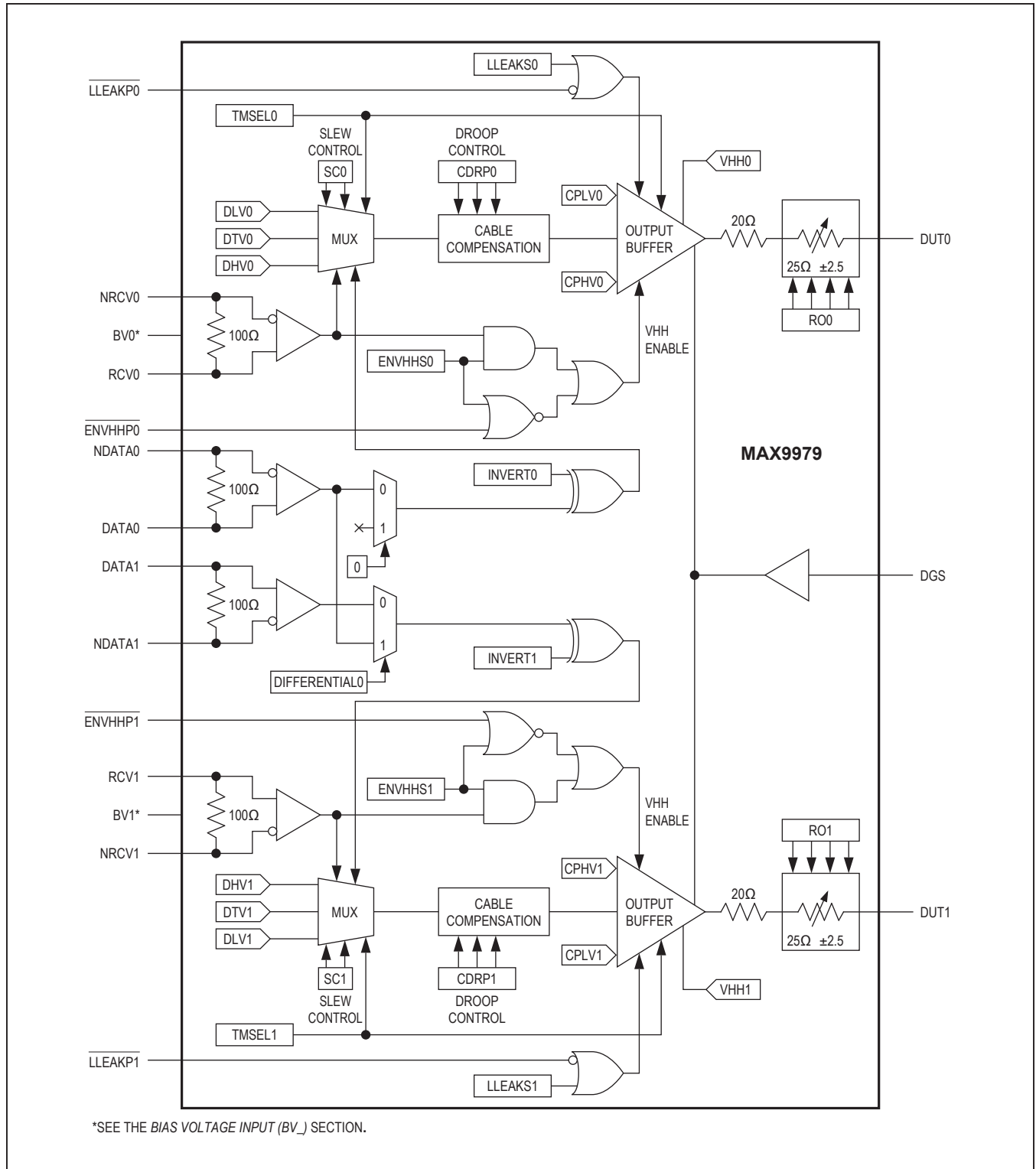

Figure 3. Driver Block Diagram

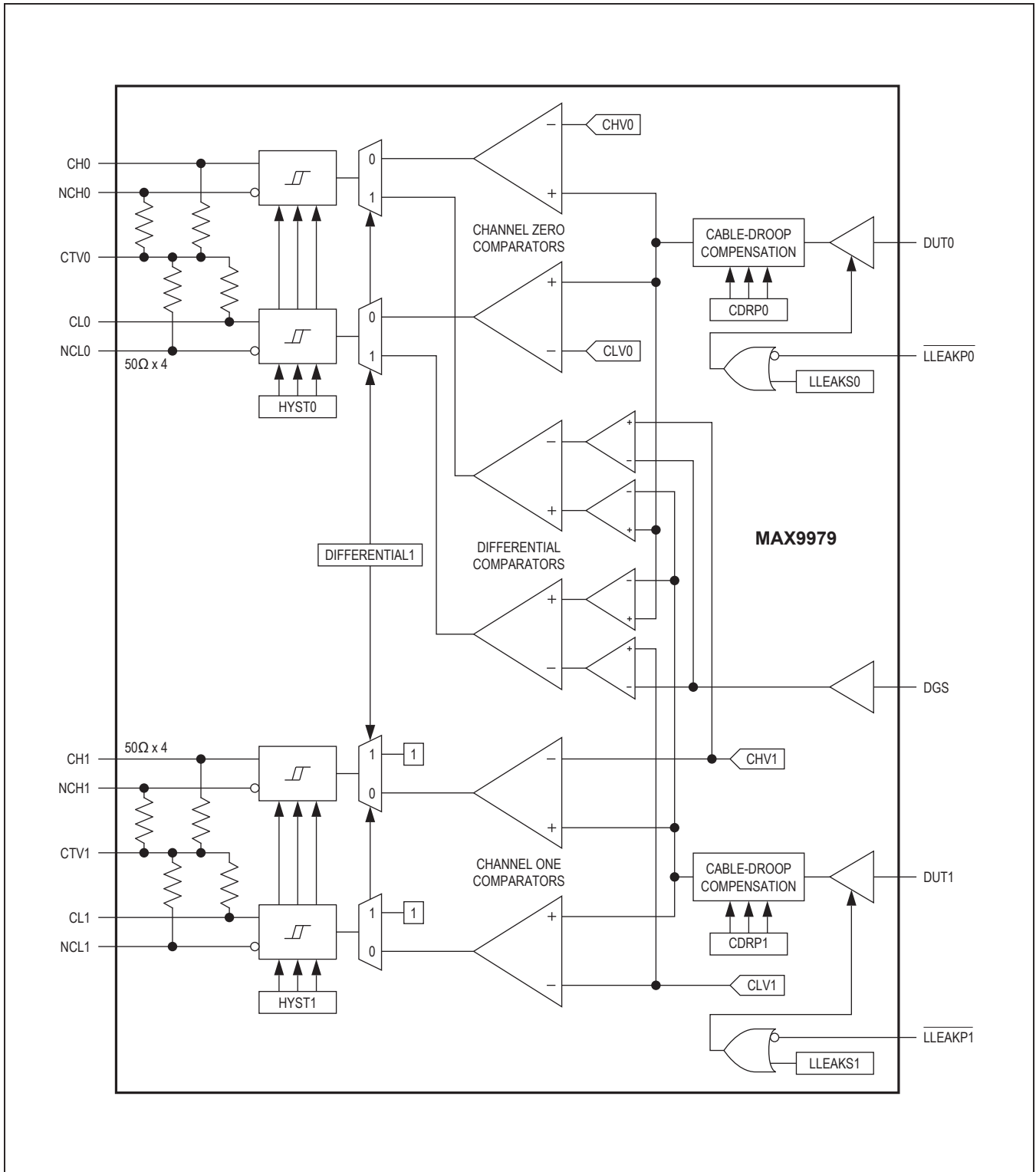

Figure 4. High-Speed Comparators Block Diagram

Table 7. Differential Window Comparator Truth Table

CONDITION		CH0	CL0
$V_{DUT0} - V_{DUT1} < V_{CHV1} - V_{DGS}$	$V_{DUT0} - V_{DUT1} < V_{CLV1} - V_{DGS}$	0	0
$V_{DUT0} - V_{DUT1} < V_{CHV1} - V_{DGS}$	$V_{DUT0} - V_{DUT1} > V_{CLV1} - V_{DGS}$	0	1
$V_{DUT0} - V_{DUT1} > V_{CHV1} - V_{DGS}$	$V_{DUT0} - V_{DUT1} < V_{CLV1} - V_{DGS}$	1	0
$V_{DUT0} - V_{DUT1} > V_{CHV1} - V_{DGS}$	$V_{DUT0} - V_{DUT1} > V_{CLV1} - V_{DGS}$	1	1

Differential Window Comparator

Set the DIFFERENTIAL1 bit = 1 in the channel 1 DCL register to enable the high-speed differential window comparator. CHV1 and CLV1 control the differential comparator thresholds. CHV0 and CLV0 are not used when differential comparison is active. The valid voltage range for CHV1 and CLV1 in differential comparison mode is ±1V. Setting levels outside ±1V does not damage the device, but performance is not guaranteed. Differential comparator outputs are multiplexed to the channel 0 comparator outputs. The channel 1 comparator outputs are both forced to a high state. Figure 4 shows the operation of the comparators. Table 7 shows the truth table for the differential comparator. Figure 4 shows the comparator block diagram.

Comparator Hysteresis

The DCL calibration register controls the high-speed comparator hysteresis. The HYST bits of that register

select one of eight values (0, 2mV, 4mV, 6mV, 8mV, 10mV, 12mV, or 15mV). Hysteresis control affects both single-ended and differential comparators. The HYST bits are set to 0b000 at power-up or when \overline{RST} is forced low. Table 8 shows the HYST bit functions.

Table 8. Hysteresis Logic

SERIAL-INTERFACE BITS			COMPARATOR HYS-TERESIS (MV)
HYST1_	HYST1_	HYST0_	
0	0	0	0
0	0	1	2
0	1	0	4
0	1	1	6
1	0	0	8
1	0	1	10
1	1	0	12
1	1	1	15

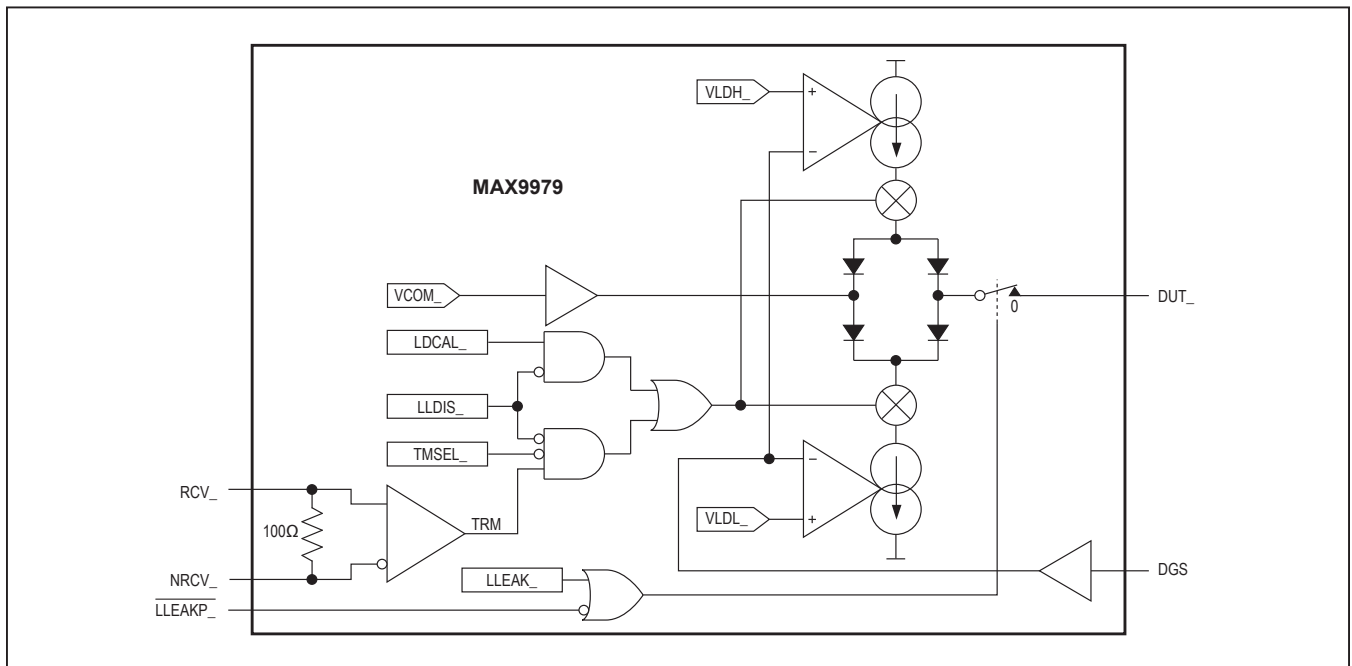

Figure 5. Active Load Block Diagram (One Channel Shown)

Comparator Cable-Droop Compensation

Control comparator cable-droop compensation using the same serial bits used for the driver droop compensation, CDRP_. Cable-droop compensation is active for both the single-ended and the differential comparators.

Active Load

The active load is a linearly programmable current source and sink, a commutation buffer, and a diode bridge (Figure 5). Level-setting DACs VLDH_ and VLDL_ set the sink and source currents from 0 to 20mA. Level-setting DAC VCOM_ sets the commutation buffer output voltage. The source and sink naming convention is referenced to the MAX9979, so current out of the MAX9979 constitutes source current and current into the MAX9979 constitutes sink current.

The programmed source current loads the device under test when $V_{DUT_} < V_{COM_}$. The programmed sink current loads the device under test when $V_{DUT_} > V_{COM_}$. The high-speed differential inputs (RCV_/NRCV_) and three bits of the control word (LLDIS_, LDCAL_, and TMSEL_) control the load. LLEAKP_ and LLEAK_ place the load into low-leakage mode. The low-leakage controls override other controls. Table 9 details load control logic.

Table 9. Load Control Logic

RCV_	TMSEL_	LDDIS_	LDCAL_	LLEAKS_	LLEAKP_	LOAD STATE
X	X	X	X	1	X	LOW LEAK
X	X	X	X	X	0	LOW LEAK
0	X	0	0	0	1	OFF
X	X	1	X	0	1	OFF
1	1	0	0	0	1	OFF
1	0	0	0	0	1	ON
X	X	0	1	0	1	ON
1	0	1	X	0	1	HIGH-IMPEDANCE MODE

Table 10. PMU Current-Range Control

DIGITAL INPUT	SERIAL-INTERFACE BITS				RANGE
LLEAKP_	HIZFORCE_	RS2_	RS1_	RS0_	
X	X	0	0	0	E
X	X	0	0	1	D
X	X	0	1	0	C
X	X	0	1	1	B
X	0	1	X	X	B*
0	1	1	X	X	B*
1	1	1	X	X	A

*Range A operation is not allowed for PMU high-impedance modes—PMU defaults to range B.

Load Calibration Enable (LDCAL_)

LDCAL_ allows the load and driver to be simultaneously enabled for diagnostic purposes. LDDIS_ overrides LDCAL_.

Parametric Measurement Unit (PMU)

The MAX9979 PMU forces and measures voltages from -1.5V to 6.5V, and currents up to $\pm 50\text{mA}$. The lowest full-scale current range is $\pm 2\mu\text{A}$. Available PMU modes are force-voltage/measure voltage (FVMV), force-voltage/measure current (FVMI), force-current/measure current (FIMI), force-current/measure voltage (FIMV), force-nothing/measure voltage (FNMV), and force-nothing/measure nothing (FNMN). Figure 6 presents a block diagram on the PMU.

PMU Current-Range Selection

Three bits from the control word (RS0, RS1, and RS2) control the full-scale current range for both force-current (FI) and measure-current (MI) modes. The PMU ranges are independent of the programmed PMU mode, except range A, which is not allowed in any calibration mode. In these modes range A defaults to range B (see Table 1). Table 10 presents the PMU current-range control logic.

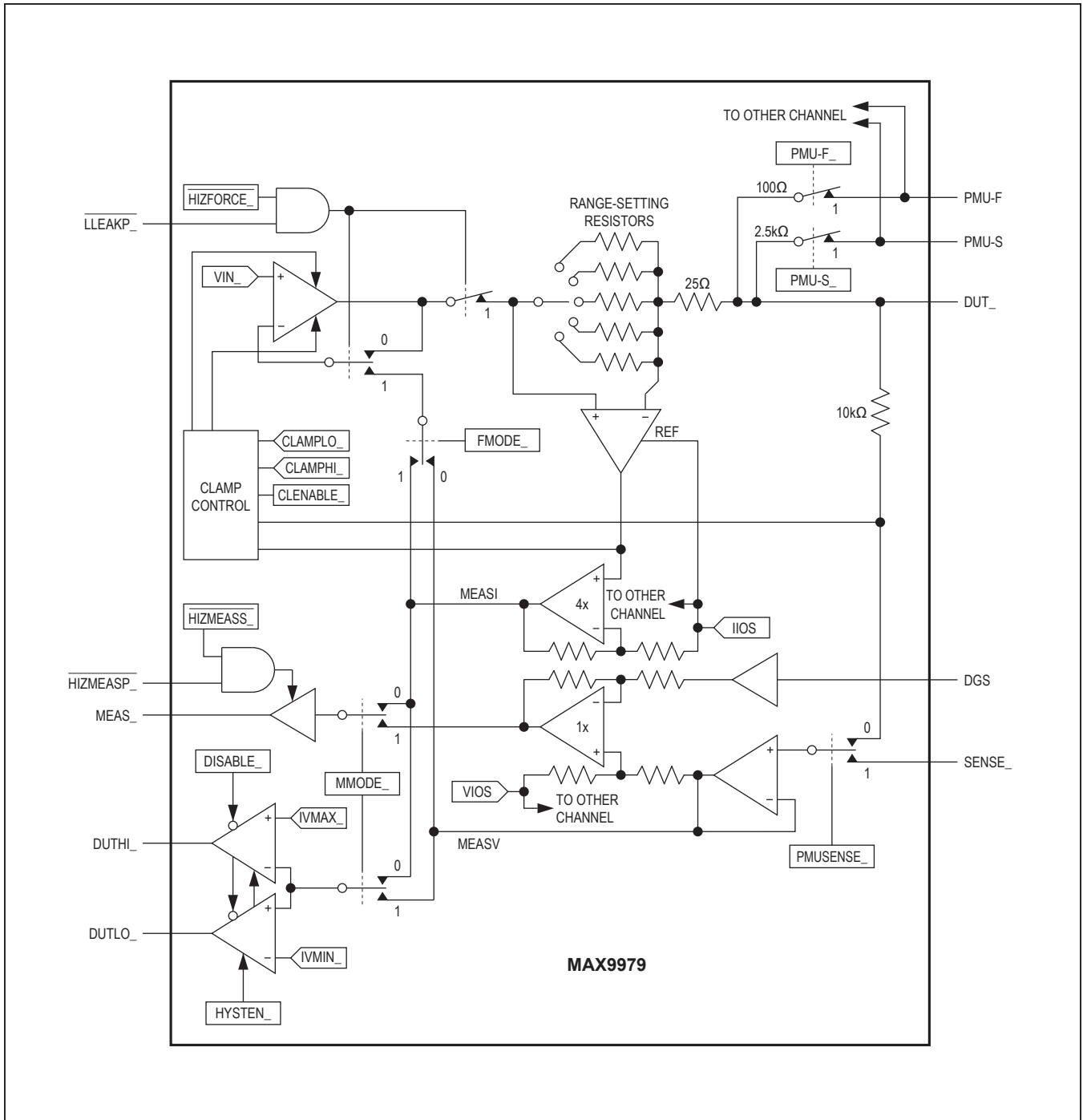

Figure 6. PMU Block Diagram (One Channel Shown)

PMU Comparators

Two comparators, configured as a window comparator, monitor the MEASV_ and MEASI_ signals (Figure 6). Level-setting DACs IVMAX_ and IVMIN_ set the high and low thresholds that determine the window (DAC IVMAX_ shares duties with VHH_). Both PMU window comparator outputs are open-drain and share a single serial disable bit (DISABLE_) that puts the outputs in a high-impedance, low-leakage state. MEAS_ includes the influence of VIOS, while the comparator outputs do not. Table 11 presents the PMU comparator output logic.

PMU Measure Output (MEAS_)

The MEAS_ output presents a voltage proportional to the measured voltage or current. Force logic input HIZMEASP_ or bit HIZMEASS_ low to place MEAS_ in a low-leakage, high-impedance state.

VIOS Offset Level for PMU Measure Voltage MEAS_ Output

In MV mode, use the VIOS level-setting DAC to offset the MEAS_ output voltage. The valid range of VIOS is 0 to 1.5V, but the VIOS DAC is programmable from -1.25V to +3.75V. The single VIOS DAC is shared by both channels. VIOS allows level shifting the MEAS_ output, useful when MEAS_ is read by a unipolar ADC. The nominal 0x0000 to 0xFFFF code range for VIOS equates to -1.25V to +3.75V. The power-on-reset and RST state of VIOS is 0x4000, or 0V, the level for normal operation. The MEAS_ output tracks DGS. The VIOS DAC range is programmable outside the valid operational range of the VIOS signal, but doing so will not harm the device. Table 23 presents the VIOS DAC transfer function.

IIOS Reference Level for PMU Measure Current MEAS_ Output

In MI mode, adjust the MEAS_ output around the I_{DUT} = 0 center reference using the IIOS level-setting DAC. IIOS is programmable from 0 to 5V, but levels outside of the 2V to 4V range are invalid. The single IIOS DAC is shared by both channels. IIOS allows level shifting the ±4V MI output range to fully above ground at the MEAS_ output, useful when MEAS_ is read by a unipolar ADC. The nominal 0x0000 to 0xFFFF code range for IIOS equates to 0 to 5V. The power-on-reset and RST state of IIOS is 0x4000, or 1.25V. For normal operation, the level of IIOS is 2.5V for a -1.5V to +6.5V MI MEAS_ output. The IIOS DAC range is programmable outside the valid operational range of the IIOS signal, but doing so will not harm the device. Table 23 presents the IIOS DAC transfer function.

The MI MEAS_ output is a buffered version of an internal node that is used to close the force-current loop. The sourcing range of forced current is limited for IIOS levels above 3.5V by the V_{IN} upper limit of approximately 7.5V.

PMU Sense

Control bit PMUSENSE_ determines which of two inputs reaches the PMU sense amplifier (Figure 6). One input is from DUT_ through an internal 10kΩ resistor, the other input is from external input SENSE_. Not shown in Figure 6 is a third input to the sense amplifier (GND), which is used in VHH and FNMN modes to isolate and protect the amplifier from potential overvoltage and glitches. GND is connected automatically based on mode setting and no discrete control is required. Table 12 presents the PMU sense control logic.

Table 11. PMU Comparator Output Logic

DISABLE_ BIT	CONDITION	COMPARATOR OUTPUTS	
		DUTHI_	DUTLO_
0	X	HIGH IMPEDANCE	HIGH IMPEDANCE
1	$V_{MEASURE} > V_{IVMAX} \text{ AND } V_{IVMIN}$	0	1
1	$V_{IVMAX} > V_{MEASURE} > V_{IVMIN}$	1	1
1	$V_{IVMAX} \text{ AND } V_{IVMIN} > V_{MEASURE}$	1	0
1	$V_{IVMIN} > V_{MEASURE} > V_{IVMAX}^*$	0	0

*Normal operation is with $V_{IVMAX} > V_{IVMIN}$. This condition has $V_{IVMIN} > V_{IVMAX}$. This does not cause any problems with the operation of the comparators.

Table 12. PMU Sense Control Logic

DIGITAL INPUT	SERIAL-INTERFACE BITS				PMU MODE	SENSE PATH
	LLEAKP_	HIZFORCE_	FMODE_	MMODE_		
1	1	X	X	0	FyMy*	Internal
1	1	X	X	1	FyMy*	External
1	0	0	X	0	FVMY* (calibration)	Internal
1	0	0	X	1	FVMY* (calibration)	External
1	0	1	0	X	FNMN	GND
1	0	1	1	0	FNMV (calibration)	Internal
1	0	1	1	1	FNMV (calibration)	External
0	X	X	0	X	FNMN	GND
0	X	X	1	0	FNMV (calibration)	Internal
0	X	X	1	1	FNMV (calibration)	External

*y = V or I.

PMU Analog Signal Polarities

In FV mode, DUT_ voltage is proportional to level-setting DAC voltage $V_{IN_}$. In FI mode, the current flowing out of DUT_ is equal to:

$$\frac{(V_{IN_} - V_{ILOS})}{4 \times R_{RANGE}}$$

Positive current is defined as flowing out of the PMU. In FN mode, the PMU output is high impedance. Table 13 presents the range resistor values. Table 23 presents the DAC transfer functions.

PMU Voltage Clamps

Voltage clamps are available on the PMU output only in the FI mode. Program the clamps with level-setting DACs CLAMPLO_ and CLAMPHI_. The PMU voltage clamps handle the full $\pm 50\text{mA}$ and are triggered by the voltage at DUT_ independent of the voltage at SENSE_. The voltage clamps override the PMU only, and do not limit the voltage of external sources. If an external source drives

DUT_ beyond a voltage clamp level, the PMU will current limit safely. When a PMU voltage clamp is active and at its limit, the MV and MI functions remain valid. Do not let external voltage levels at DUT_ exceed the absolute maximum rating limits.

PMU Current Clamps

Current clamps are available on the PMU output only in the FV mode. Program the clamps with level-setting DACs CLAMPLO_ and CLAMPHI_. The PMU current clamps handle the full current range ($\pm 50\text{mA}$ for range A, $\pm 2\text{mA}$ for range B, etc.). If the clamp currents are exceeded, the PMU enters a constant-voltage mode. The current clamp circuits override the PMU only, and do not limit external sources. When a PMU current clamp is active, the MV and MI functions are still valid.

PMU Clamp Enable

The CLENABLE_ bit in the PMU register enable the voltage and current clamps. Table 14 presents the clamp enable control logic.

Table 13. Range Resistor Values

RANGE	RESISTOR VALUE (Ω)
A	20
B	500
C	5K
D	50K
E	500K

Table 14. Clamp Enable Control Logic

CLENABLE_ BIT	MODE
1	CLAMPS ENABLED
0	CLAMPS DISABLED

PMU Voltage/Current-Limit Flags

The PMU features two comparators, arranged as a window comparator, to flag current or voltage levels, allowing fast go/no-go testing. The comparators monitor the load current or voltage, and compare it to level-setting DACs IVMAX and IVMIN. The MMODE_ bit selects whether the window comparator monitors MEASV_ or MEASI_ (Figure 6). If MMODE_ selects MEASV_ then the PMUSENSE_ bit selects either the SENSE_ input or DUT_ (Figure 6).

Independent Control of PMU Feedback Switch and Measure Switch

Two single-pole/double-throw (SPDT) switches determine the mode of operation of the PMU. One switch determines whether the sensed DUT_ current or DUT_ voltage is fed back to the input, and thus determines which of these parameters is forced. The other switch determines whether the sensed DUT_ current or DUT_ voltage is presented at MEAS_. Independent control of these switches and the force high-impedance state allow for flexible modes of operation beyond the traditional force-voltage/measure-current (FVMI) and force-current/measure-voltage (FIMV) modes. The modes supported are:

- FVMI: Force-voltage/measure-current mode
- FIMV: Force-current/measure-voltage mode
- FVMV: Force-voltage/measure-voltage mode
- FIMI: Force-current/measure-current mode
- FNMV: Force-nothing/measure-voltage mode
- FNMN: Force-nothing/measure-nothing mode

PMU Measure Output High-Impedance Control

The MEAS_ output features a low-leakage, high-impedance state. To activate this state, either place the HIZMEASS_ bit low or force the HIZMEASP_ logic input low. The two controls are logically ANDed together (Figure 6). The HIZMEASP_ input allows multiplexing between PMU measure outputs without the use of the serial interface. At power-up, HIZMEASS_ defaults low, placing MEAS_ in a high-impedance state. Table 15 presents the high-impedance control logic for the MEAS_ output.

PMU Low-Leakage Mode

The PMU output features a low-leakage, high-impedance state. To activate this state, either place the HIZFORCE_ bit low or force the LLEAKP_ logic input low. The two controls are logically ANDed together (Figure 6). At power-up, HIZFORCE_ defaults low, placing the PMU in a low-leakage state. Table 1 presents the low-leakage logic for the PMU output.

Table 15. Measure Output High-Impedance Control Logic

HIZMEASS_ BIT	HIZMEASP_ INPUT	MEAS_ STATE
1	1	Measure output enabled
1	0	High impedance
0	1	High impedance
0	0	High impedance

PMU DUT Ground Sense (DGS)

All the DAC and MEAS_ outputs track with respect to the DUT ground sense input (DGS). Connect DGS to the ground of the device under test.

PMU DUT_ Node Force and Sense Switches

The MAX9979 features additional PMU force (PMU-F) and PMU sense (PMU-S) connections, through serial-controlled switches, that are shared between channels (Figure 6) and can be used to connect an external PMU. The force switch is maximum 100Ω, and the sense switch is maximum 2.5kΩ.

PMU DUT_ Voltage Swing vs. DUT_ Current and Power-Supply Voltages

Two issues limit the DUT_ voltage that the PMU delivers. The first issue is the headroom required by the amplifiers and other on-chip circuitry at zero output current. The second issue is the headroom required with sense resistor and additional circuit voltage drops at full-scale current. When the PMU is sourcing or sinking DUT_ current, the voltage range is reduced linearly. This compliance curve applies to both FV and FI modes and is independent of V_{DGS}. Because the forced DUT_ voltage in FV mode is = DGS + V_{IN}, V_{DUT_} is further limited by the V_{DGS} and the -2.5V to +7.5V V_{IN} range. Force output capabilities of the PMU are presented in Figure 7.

These limitations are based on the guaranteed performance of the MAX9979. Operating the DUT node outside these limits will not harm the MAX9979, as long as the absolute maximum rating limits are observed. With the above considerations, it is possible to extend the range of the DUT swing beyond the limits of Figure 7. However, some specifications, such as linearity, will begin to degrade. Performance while operating outside the limits shown in Figure 7 is not guaranteed.

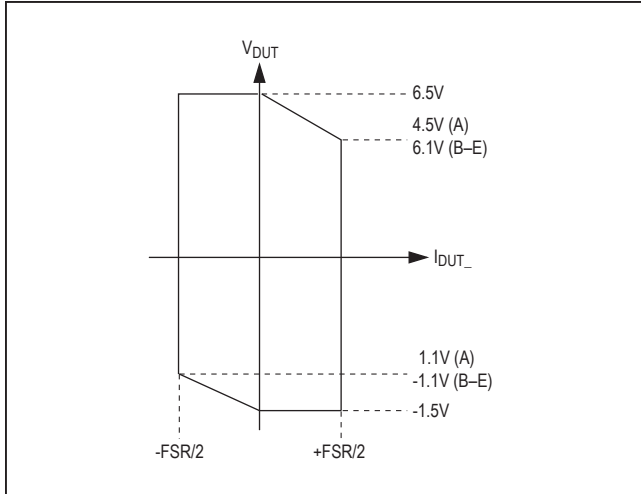

Figure 7. Output-Voltage Range

Serial Interface

An SPI-compatible serial interface and the logic-controlled inputs shown in Table 1 control the MAX9979. The serial interface, detailed in Figure 8, operates with clock

speeds up to 50MHz and includes the signals \overline{CS} , SCLK, DIN, \overline{RST} , \overline{LOAD} , and DOUT. Serial-interface timing is shown in Figure 9 and timing specifications are detailed in the *Electrical Characteristics* section.

Loading Data into the MAX9979

Load data into the 24-bit shift register from DIN on the rising edge of SCLK, while \overline{CS} is low (Figure 8). The MAX9979 is updated when the control and level-setting data are latched into the control and level-setting registers. The control and level-setting registers are separated from the shift register by the input and channel-select registers. Two methods allow data to transfer from the shift register to the control and level-setting registers, depending on the state of external digital input \overline{LOAD} .

Holding \overline{LOAD} high during the rising edge of \overline{CS} allows the shift register data to transfer only into the input and channel-select registers. Force \overline{LOAD} low to transfer the data into the control and level-setting registers. Changes update on the falling edge of \overline{LOAD} , which allows preloading of data and facilitates synchronizing updates across multiple devices.

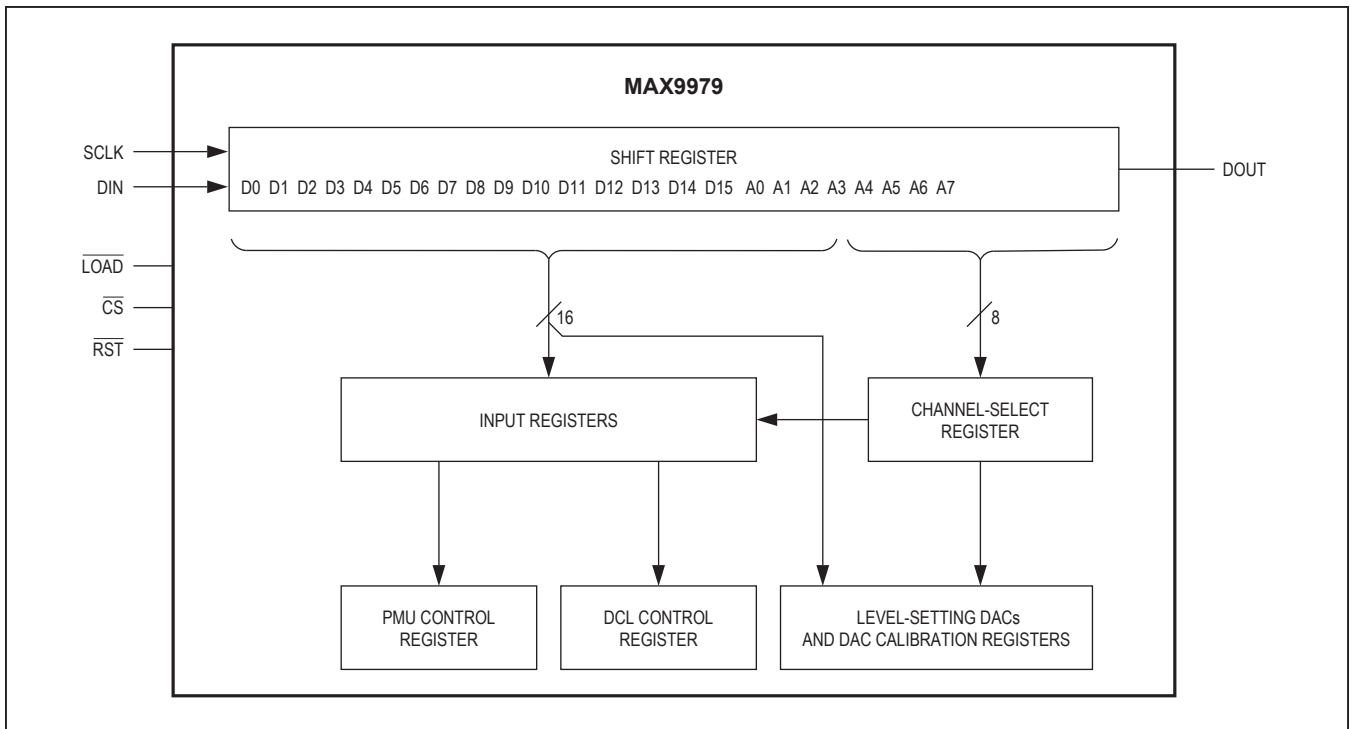

Figure 8. Serial-Interface Block Diagram

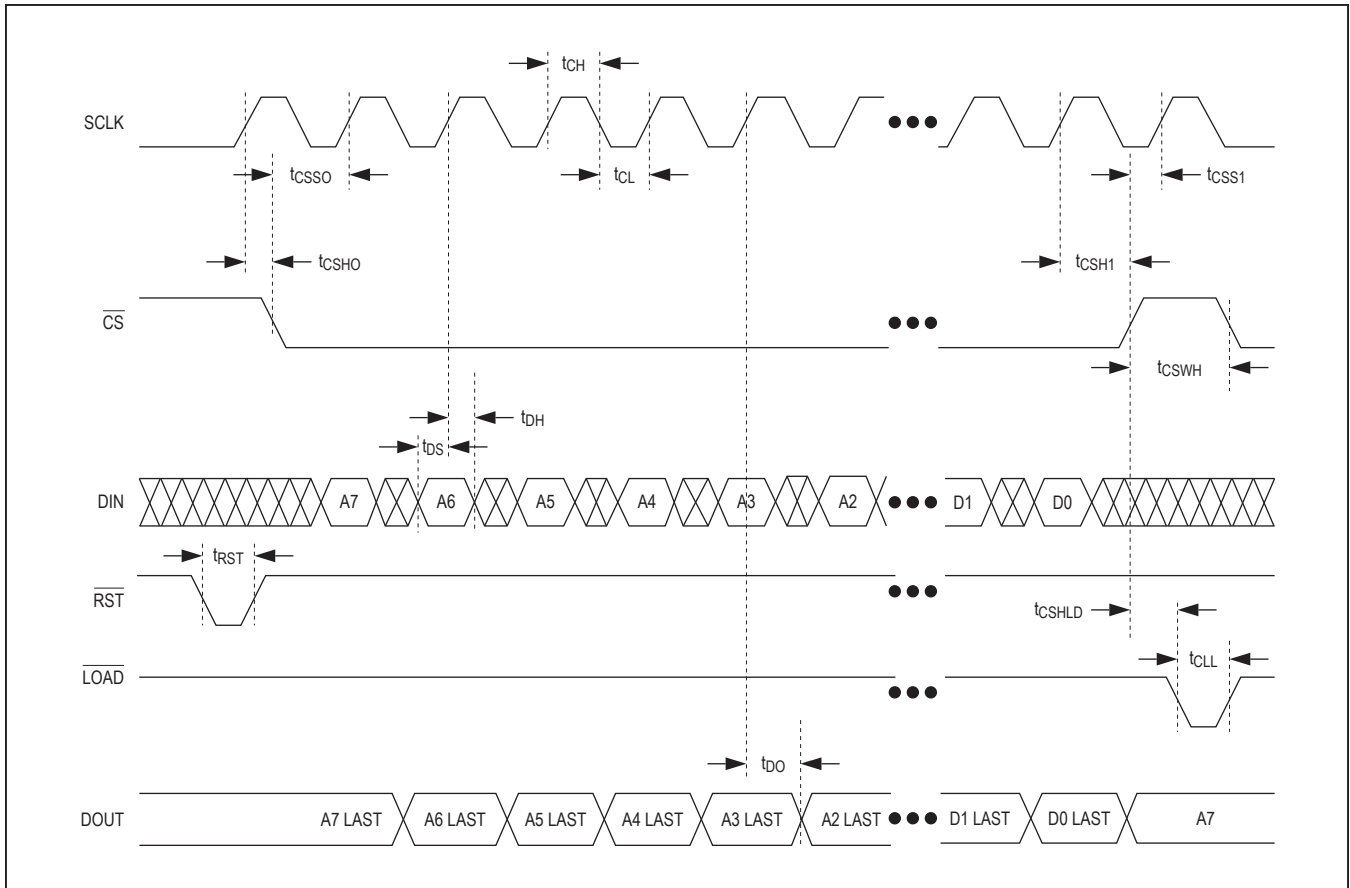

Figure 9. Serial-Interface Timing

Holding \overline{LOAD} low during the rising edge of \overline{CS} forces the input and channel-select registers to become transparent and all data transfers through these registers directly to the control and level-setting registers. Changes update on the rising edge of \overline{CS} . Figures 10 and 11 show how \overline{LOAD} and \overline{CS} function, and also the data configuration of SCLK, DIN, and DOUT.

The calibration registers change on the rising edge of \overline{CS} , regardless of the state of \overline{LOAD} .

DOUT

DOUT is a buffered version of the last bit in the serial-interface shift register. The complete contents of the shift register can be read at DOUT during the next write cycle. To shift data out without modifying any registers, perform a write with address bits A4 and A5 set to 0. Use DOUT to

daisy chain multiple devices, and/or to verify that data were properly shifted in during the previous communication.

Controlling the MAX9979

Control and level-setting registers are selected to receive data based on the channel and mode-select bits (A0–A7). Table 16 presents the control register bits and their functions. Level-setting DAC data and control-register data are contained in the 16 data bits D0–D16. Tables 15, 16, and 17 detail the bit functions. Clock in bit A7 first, and bit D0 last, as shown in Figure 8.

Bit A6 allows access to the DAC calibration registers. Use the calibration registers to adjust the gain and offset of each DAC. Set bit A6 to write to the calibration registers (Table 18). See the *Level-Setting DACs* section for more information.

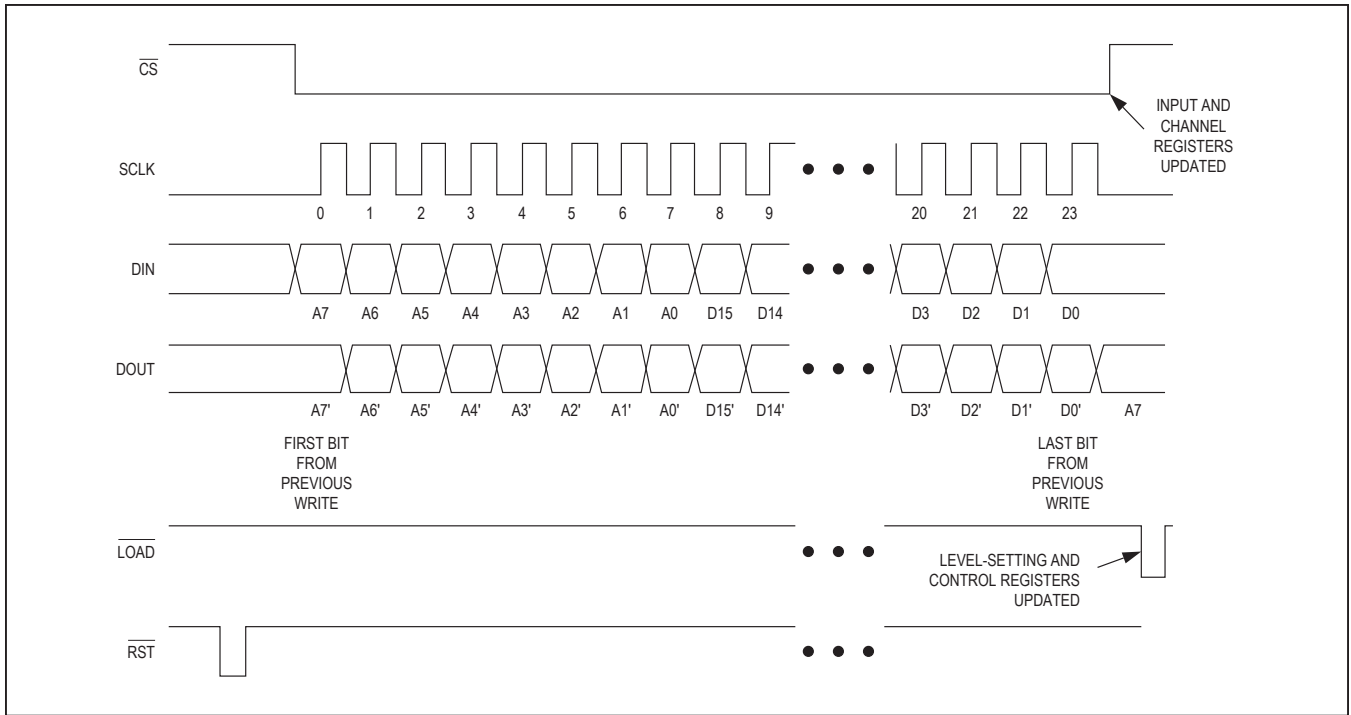

Figure 10. Using \overline{LOAD} to Update the Level-Setting and Control Registers

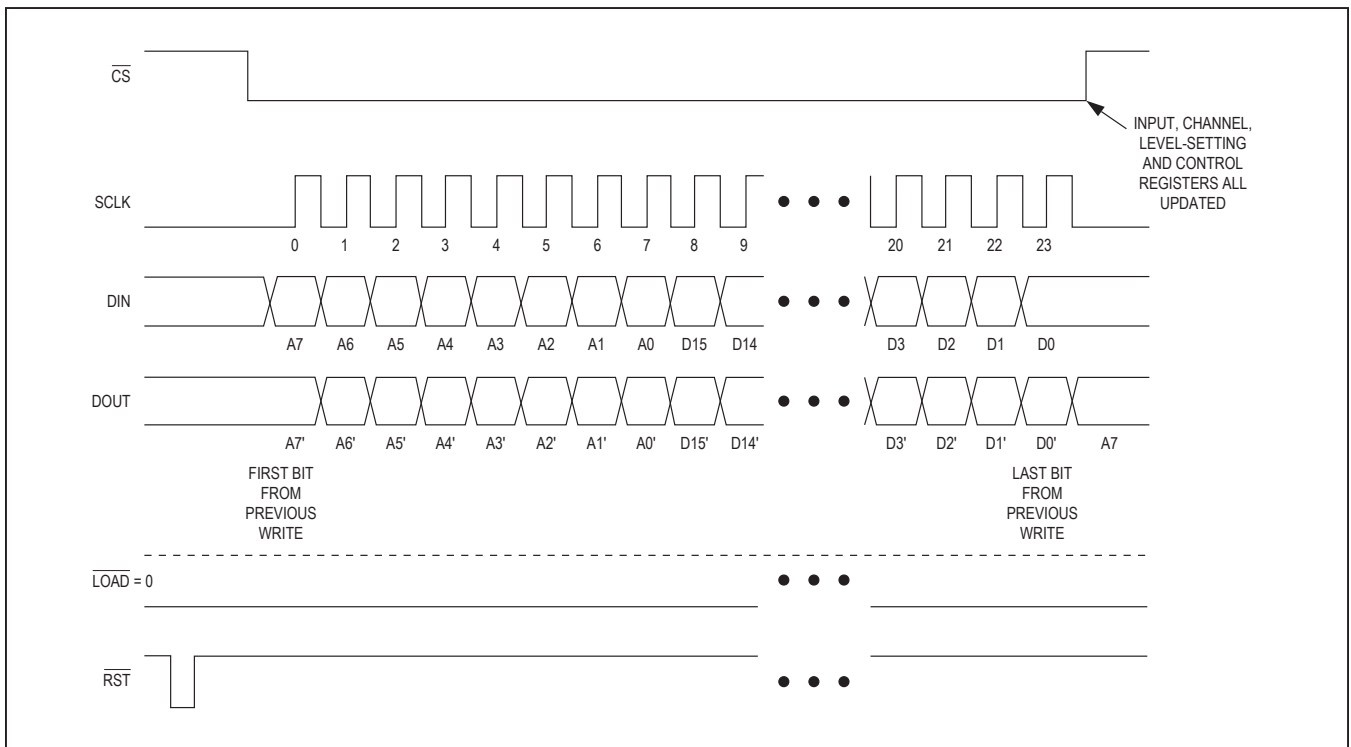

Figure 11. Using \overline{CS} to Update the Level-Setting and Control Registers (\overline{LOAD} Held Low)

Table 16. MAX9979 Control and Calibration Register Bits

REGISTER	FUNCTION
CDRP_	DRIVER AND COMPARATOR CABLE-DROOP COMPENSATION
CLENABLE_	PMU CLAMP ENABLE
DIFFERENTIAL0	SELECT DATA1/NDATA1 AS DATA CONTROL FOR BOTH CHANNELS 1 AND 2 (FIGURE 3)
DIFFERENTIAL1	ENABLE DIFFERENTIAL COMPARATOR OUTPUTS (FIGURE 4)
DISABLE_	PMU COMPARATOR OUTPUT DISABLE
ENVHHS_	VHH_ MODE ENABLE
FMODE_	PMU FORCE-MODE CONTROL
GCAL_	DAC GAIN CALIBRATION
HIZFORCE_	PMU DUT_ HIGH-IMPEDANCE CONTROL
HIZMEASS_	PMU MEASURE OUTPUT HIGH-IMPEDANCE CONTROL
HYST_	HIGH-SPEED COMPARATOR HYSTERESIS SELECT
HYSTEN_	PMU COMPARATOR HYSTERESIS ENABLE
INVERT_	DATA_/NDATA_ POLARITY CONTROL
LDCAL_	LOAD CALIBRATION ENABLE
LDDIS_	LOAD DISABLE
LLEAKS_	DCL LOW-LEAK ENABLE
MMODE_	PMU MEASURE-MODE CONTROL
OCAL_	DAC OFFSET CALIBRATION
PMU-F_	FORCE SWITCH ENABLE (FIGURE 6)
PMU-S_	SENSE SWITCH ENABLE (FIGURE 6)
PMUSENSE_	PMU MEASV INPUT CONTROL
RO_	DRIVER OUTPUT RESISTANCE SELECT
RS_	PMU CURRENT RANGE SELECT
SC_	DRIVER SLEW-RATE CONTROL
TMSEL_	DRIVER TERMINATE SELECT CONTROL
TMUX_	FACTORY USE ONLY. PROGRAM TO 0.

Table 17. Serial-Input Data Overview

BIT	FUNCTION
A7	NOT USED. WRITE 0 OR 1
A6	CALIBRATION REGISTER WRITE ENABLE
A5	CHANNEL 1 WRITE ENABLE
A4	CHANNEL 0 WRITE ENABLE
A3–A0	REGISTER ADDRESS (SEE TABLE 18)
D15–D0	REGISTER DATA (SEE TABLE 19)

Table 18. Register Address Bits

BITS				REGISTER	
A3	A2	A1	A0	A6 = 0	A6 = 1
0	0	0	0	DCL CONTROL	DCL CALIBRATION
0	0	0	1	DHV LEVEL	DHV CALIBRATION
0	0	1	0	DLV LEVEL	DLV CALIBRATION
0	0	1	1	DTV LEVEL	DTV CALIBRATION
0	1	0	0	CHV LEVEL/PMU IVMAX	CHV CALIBRATION
0	1	0	1	CLV LEVEL/PMU IVMIN	CLV CALIBRATION
0	1	1	0	CPHV LEVEL	CPHV CALIBRATION
0	1	1	1	CPLV LEVEL	CPLV CALIBRATION
1	0	0	0	PMU CONTROL	—
1	0	0	1	VIN LEVEL	VIN CALIBRATION
1	0	1	0	VCOM LEVEL	VCOM CALIBRATION
1	0	1	1	VLDH LEVEL	VLDH CALIBRATION
1	1	0	0	VLDL LEVEL	VLDL CALIBRATION
1	1	0	1	VIOS/IIOS* LEVEL	VIOS/IIOS* CALIBRATION
1	1	1	0	CLAMPHI/VHH LEVEL	CLAMPHI/VHH CALIBRATION
1	1	1	1	CLAMPLO LEVEL	CLAMPLO CALIBRATION

*Channel 0 register programs the VIOS level; channel 1 register programs the IIOS level. Select channels with bits A4 and A5.

Table 19. Data Bit Assignments*

BIT	FUNCTION					
	DCL CONTROL REGISTER**	DCLCALIBRATION REGISTER**	PMU CONTROL REGISTER**	LEVEL-SETTER REGISTER	DAC GAIN AND OFFSET CALIBRATION REGISTERS	
					VIN	ALL OTHERS
D0	SC0	RO0	FMODE_	BIT 0 (LSB)	OCAL0	OCAL0
D1	SC1	RO1	MMODE_	BIT 1	OCAL1	OCAL1
D2	LLEAKS	RO2	RS0_	BIT 2	OCAL2	OCAL2
D3	TMSEL	RO3	RS1_	BIT 3	OCAL3	OCAL3
D4	LDDIS	HYST0	RS2_	BIT 4	OCAL4	OCAL4
D5	INVERT	HYST1	CLENABLE_	BIT 5	OCAL5	OCAL5
D6	DIFFERENTIAL	HYST2	HIZFORCE_	BIT 6	OCAL6	OCAL6
D7	LDCAL	CDRP0	HIZMEASS_	BIT 7	OCAL7	OCAL7
D8	ENVHHS	CDRP1	DISABLE_	BIT 8	GCAL0	GCAL0
D9	TMUX0 = 0	CDRP2	PMUSENSE_	BIT 9	GCAL1	GCAL1
D10	TMUX1 = 0	—	HYSTEN_	BIT 10	GCAL2	GCAL2

*The data bits enter the shift register in the order, MSB to LSB.

**The DCL control, DCL calibration, and PMU control registers default to 0x0004, 0x0008, and 0x0003 respectively at power-up.

Table 19. Data Bit Assignments* (continued)

BIT	FUNCTION					
	DCL CONTROL REGISTER**	DCLCALIBRATION REGISTER**	PMU CONTROL REGISTER**	LEVEL-SETTER REGISTER	DAC GAIN AND OFFSET CALIBRATION REGISTERS	
					VIN	ALL OTHERS
D11	TMUX2 = 0	—	PMU-F	BIT 11	GCAL3	GCAL3
D12	TMUX3 = 0	—	PMU-S	BIT 12	GCAL4	GCAL4
D13	—	—	—	BIT 13	GCAL5	GCAL5
D14	—	—	—	BIT 14	GCAL6	—
D15	—	—	—	BIT 15 (MSB)	—	—

*The data bits enter the shift register in the order, MSB to LSB.

**The DCL control, DCL calibration, and PMU control registers default to 0x0004, 0x0008, and 0x0003 respectively at power-up.

Level-Setting DACs

The MAX9979 includes 28 level-setting DACs that provide the DC voltage levels for the various control and monitor circuits of the 2-channel MAX9979. Some of the DACs are shared between the MAX9979 channels, and some perform dual functions within a channel (Figure 12). Important details about the operation of shared DACs are:

- VIOS share a common DAC level for both channels. VIOS DAC simultaneously updates the VIOS1 and VIOS2 levels.
- IIOS share a common DAC level for both channels. The IIOS DAC simultaneously updates the IIOS1 and IIOS2 levels.
- CLAMPHI_ and VHH_ share a common DAC level. The CLAMPHI_/VHH_ DAC simultaneously updates the CLAMPHI_ and VHH_ levels. Note that the VHH_ output is 0 to +13V. If CLAMPHI_ is set to a negative value and the VHH_ mode is selected, the VHH_ output limits close to 0V.
- CHV_ and IVMAX_ share a common DAC level. The CHV_/IVMAX_ DAC simultaneously updates the CHV_ and IVMAX_ levels.
- CLV_ and IVMIN_ share a common DAC level. The CLV_/IVMIN_ DAC simultaneously updates the CLV_ and IVMIN_ levels.

A 16-bit code that varies between 0x0000 and 0xFFFF sets all DAC levels. Table 20 presents a list of the DACs and their default values.

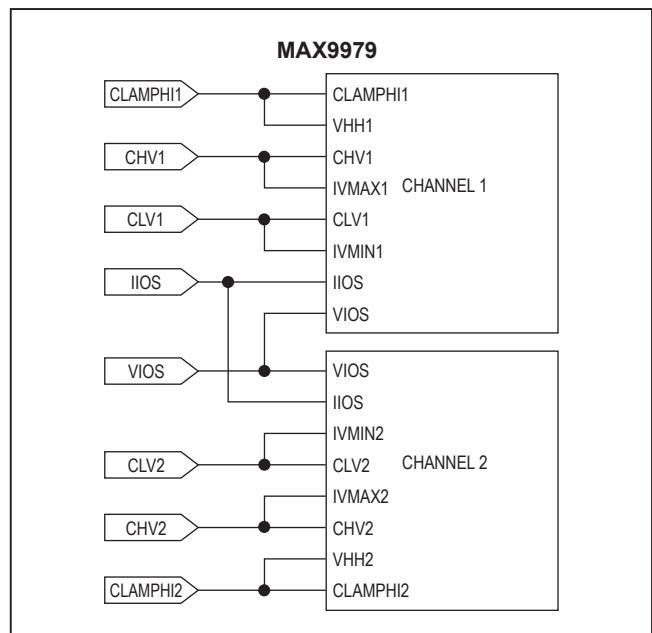

Figure 12. Arrangement of Shared DACs

Calibrating DAC Gain and Offset

DAC calibration registers adjust the gain and offset of each DAC. Each DAC has at least one calibration register. All DAC calibration registers are programmed with a 14-bit code, except VIN_, which uses a 15-bit code (Table 19). The codes are divided into two fields, one field each for gain (GCAL_) and offset (OCAL_). VIN_ has a 7-bit field for gain and an 8-bit field for offset. All other DACs have a 6-bit field for gain and an 8-bit field for offset.

The VCH_, VCL_, and VIN_ DACs have duplicate calibration registers that are selected and addressed as a function of the selected DCL/PMU modes. The VCH_ and VCL_ registers each have three separate calibration registers that are used by the window comparator, the differential comparator, and the PMU comparator, respectively. The VIN_ register features six duplicate calibration registers that are selected as a function of the PMU force mode. These registers are individually addressed by first selecting the appropriate mode, then performing the register

write. After the calibration registers are programmed, the appropriate register is automatically switched in as a function of the operating mode.

Table 20 presents a list of the DAC registers and their default values. Calibration registers are programmed to default values only during a power-on reset. Asserting \overline{RST} does not force the calibration registers to their default values. Table 21 summarizes the DAC register addresses. Figure 13 shows how the calibration registers affect the DAC outputs.

Table 20. DAC Power-Up and Reset Default Values

DAC	DESCRIPTION	LEVEL-SETTING REGISTER POWER-UP AND RST VALUE	CALIBRATION REGISTER POWER-UP VALUE*
DHV_	Driver high	0x4000	0x2080
DLV_	Driver low	0x4000	0x2080
DTV_	Driver term	0x4000	0x2080
CHV_/IVMAX_	High comparator/PMU high comparator	0x4000	0x2080
CLV_/IVMIN_	Low comparator/PMU low comparator	0x4000	0x2080
CPHV_	High high-impedance clamp	0x4000	0x2080
CPLV_	Low high-impedance clamp	0x4000	0x2080
VIN_	PMU force value	0x4000	0x4080
VCOM_	Load commutation voltage	0x4000	0x2080
VLDH_	Load source current	0x4000	0x2080
VLDL_	Load sink current	0x4000	0x2080
VIOS	PMU measure voltage offset	0x4000	0x2080
IIOS	PMU force/measure current offset	0x4000	0x2080
CLAMPHI_/VHH_	PMU high clamp/driver super voltage	0x4000	0x2080
CLAMPLO_	PMU low clamp	0x4000	0x2080

*Calibration registers not affected by \overline{RST} .

Table 21. DAC Level-Setting and Calibration Register Addresses

DAC	DESCRIPTION	LEVEL-SETTING REGISTER ADDRESS			CALIBRATION REGISTER ADDRESS			NOTES
		CH 0	CH 1	BOTH	CH 0	CH 1	BOTH	
DHV_	Driver high	0x11	0x21	0x31	0x51	0x61	0x71	—
DLV_	Driver low	0x12	0x22	0x32	0x52	0x62	0x72	—
DTV_	Driver term	0x13	0x23	0x33	0x53	0x63	0x73	—
CHV_ /IVMAX_	High comparator/PMU high comparator	0x14	0x24	0x34	0x54	0x64	0x74	1, 3
CLV_ /IVMIN_	Low comparator/PMU low comparator	0x15	0x25	0x35	0x55	0x65	0x75	2, 3
CPHV_	High high-impedance clamp	0x16	0x26	0x36	0x56	0x66	0x76	—
CPLV_	Low high-impedance clamp	0x17	0x27	0x37	0x57	0x67	0x77	—
VIN_	PMU force value	0x19	0x29	0x39	0x59	0x69	0x79	3
VCOM_	Load commutation voltage	0x1A	0x2A	0x3A	0x5A	0x6A	0x7A	—
VLDH_	Load source current	0x1B	0x2B	0x3B	0x5B	0x6B	0x7B	—
VLDL_	Load sink current	0x1C	0x2C	0x3C	0x5C	0x6C	0x7C	—
VIOS	PMU measure voltage offset	0x1D	—	—	0x5D	-	—	4
IIOS	PMU force/measure current offset	—	0x2D	—	—	0x6D	—	5
CLAMPHI_ /VHH_	PMU high clamp/driver super voltage	0x1E	0x2E	0x3E	0x5E	0x6E	0x7E	3, 6
CLAMPLO_	PMU low clamp	0x1F	0x2F	0x3F	0x5F	0x6F	0x7F	—

Note 1: A common DAC is used for both the CHV_ and IVMAX_ levels.

Note 2: A common DAC is used for both the CLV_ and IVMIN_ levels.

Note 3: The CHV_ and CLV_ levels each have a pair of calibration registers. One is active when using the window comparator; the other is active when using the differential comparator. The VIN_ level has six calibration registers corresponding to the force voltage and the five ranges of force current modes of the PMU. The CLAMPHI_, VHH_, IVMAX_, and IVMIN_ levels each have their own dedicated calibration register. Addressing any of these calibration registers requires device mode settings (Table 22) as well as the register's address.

Note 4: The VIOS level is common to both channels. A channel 0 DAC is used to generate VIOS.

Note 5: The IIOS level is common to both channels. A channel 1 DAC is used to generate IIOS.

Note 6: A common DAC is used for both the CLAMPHI_ and VHH_ levels.

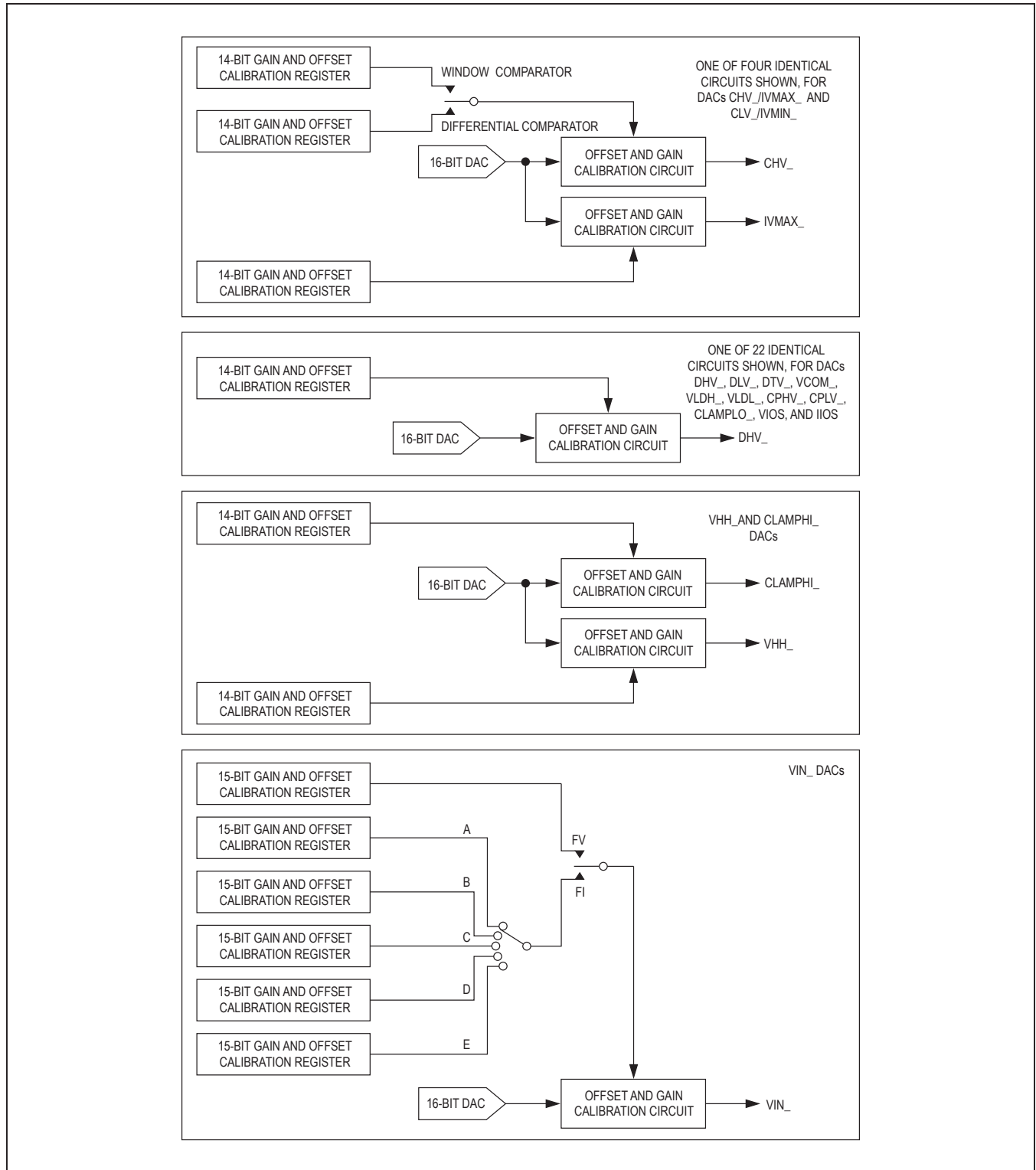

Figure 13. DAC Calibration Registers

An example calibration sequence follows:

- 1) Power up the MAX9979. This sets the level-setting DACs to their default 0V values, and the gain and offset calibration registers to their default midscale values (Table 20).
- 2) Gain calibration (gain must be calibrated before calibrating offset).
 - a. Program a level-setting DAC to its minimum value and measure the output voltage (V_{OUT_MIN}). Then, reprogram the DAC to its maximum value and again measure the output voltage (V_{OUT_MAX}). Calculate the gain using the following equation:

$$GAIN = \frac{V_{OUT_MAX} - V_{OUT_MIN}}{V_{SET_MAX} - V_{SET_MIN}}$$

where V_{SET_MAX} and V_{SET_MIN} are the desired gain calibration points.

- b. Set the DACs gain calibration register until the gain is as close to 1 as possible. This calibrates the gain for the DAC. Record the gain calibration register value for later use.
- 3) Offset calibration (must be done after the gain

calibration).

- a. Set the level of the DAC to the desired offset calibration point (e.g., midscale).
 - b. Measure $V_{OUT_}$ and compare it to the expected output.
 - c. Adjust the offset calibration register until $V_{OUT_}$ is as close as possible to the expected voltage. Record the value of the offset calibration register for later use.
- 4) Repeat the above procedure for all DACs that need calibration, recording each of the gain and offset calibration register settings for later use.

The prior procedure only needs to be done once. Each time the power is cycled, simply reprogram the gain and offset registers using the recorded values.

Table 22 presents the mode settings required to access the calibration registers of the shared DACs. In some cases there is more than one way to access the register.

Table 22. Mode-Control Settings to Access Calibration Registers of Shared DACs

CALIBRATION REGISTER		SERIAL-INTERFACE BITS						
DAC	MODE	HIZFORCE_	DIFFERENTIAL1	FMODE_	MMODE_	RS_BIT		
						2	1	0
CLV_, CHV_	Window	0	0	X	X	X	X	X
	Differential	0	1	X	X	X	X	X
IVMAX_, IVMIN_	—	1	X	X	X	X	X	X
CLAMPHI_	—	1	X	X	X	X	X	X
VHH_	—	0	X	X	X	X	X	X
VIN_	FV*	0	X	X	0	X	X	X
		1	X	0	X			
	FI Range A	1	X	1	X	1	X	X
	FI Range B*	0	X	X	1	1	X	X
		0	X	X	1			
		1	X	1	X			
	FI Range C*	0	X	X	1	0	1	0
		1	X	1	X			
	FI Range D*	0	X	X	1	0	0	1
		1	X	1	X			
	FI Range E*	0	X	X	1	0	0	0
		1	X	1	X			

*Any of these conditions allow access to the calibration register.

DAC Output Level Transfer Functions

Each of the MAX9979 analog DAC levels is set with a transfer function that includes the 16-bit DAC code setting, the gain code setting, and the offset code setting. The V_{DAC} and V_{VINDAC} expressions below present the basic DAC transfer functions. Each DAC has a voltage output range of -2.5V to +7.5V (typ). Thirteen of these DACs are identical and generate a potential according to the following equation:

$$V_{DAC} = \left(\left(\frac{DAC_{CODE}}{16384} - 1 \right) \times (V_{REF} - V_{DGS}) + (OFFSET_{CODE} \times 0.001) - 0.128 \right) \times \left(0.98 + 0.02 \times \left(\frac{GAIN_{CODE}}{32} \right) \right) + V_{DGS}$$

A separate DAC ($V_{IN_}$) is used for the PMU force value. This DAC has a finer gain adjustment resolution and follows the equation:

$$V_{VINDAC} = \left(\left(\frac{DAC_{CODE}}{16384} - 1 \right) \times (V_{REF} - V_{DGS}) + (OFFSET_{CODE} \times 0.001) - 0.128 \right) \times \left(0.98 + 0.02 \times \left(\frac{GAIN_{CODE}}{64} \right) \right) + V_{DGS}$$

For all DACs, the offset code is an integer value between 0 and 255. The V_{IN_DAC} gain code is an integer value between 0 and 127, and for all other DACs the gain code is an integer value between 0 and 63. Offset and gain codes are based on the calibration register settings.

Table 23. DAC Transfer Functions

LEVEL	LEVEL TRANSFER FUNCTION
DHV_	$V_{DAC} \times DHV_gain + DHV_offset$
DLV_	$V_{DAC} \times DLV_gain + DLV_offset$
DTV_	$V_{DAC} \times DTV_gain + DTV_offset$
CHV_	$V_{DAC} \times CHV_gain + CHV_offset$
IVMAX_	$V_{DAC} \times IVMAX_gain + IVMAX_offset$
CLV_	$V_{DAC} \times CLV_gain + CLV_offset$
IVMIN_	$V_{DAC} \times IVMIN_gain + IVMIN_offset$
CPHV_	$V_{DAC} \times CPHV_gain + CPHV_offset$
CPLV_	$V_{DAC} \times CPLV_gain + CPLV_offset$
VIN_ (FVMI)	$V_{VINDAC} \times PMU_FV_gain + PMU_FV_offset$
VIN_ (FIMV 50mA)	$(V_{VINDAC} - V_{ILOS}) \times (50mA/4V) \times PMU_FI_gain + PMU_FI_offset$
VIN_ (FIMV 2mA)	$(V_{VINDAC} - V_{ILOS}) \times (2mA/4V) \times PMU_FI_gain + PMU_FI_offset$
VIN_ (FIMV 200_A)	$(V_{VINDAC} - V_{ILOS}) \times (200_A/4V) \times PMU_FI_gain + PMU_FI_offset$
VIN_ (FIMV 20_A)	$(V_{VINDAC} - V_{ILOS}) \times (20_A/4V) \times PMU_FI_gain + PMU_FI_offset$
VIN_ (FIMV 2_A)	$(V_{VINDAC} - V_{ILOS}) \times (2_A/4V) \times PMU_FI_gain + PMU_FI_offset$
VCOM_	$V_{DAC} \times VCOM_gain + VCOM_offset$
VLDH_	$(V_{DAC} - DGS) \times (20mA/6V) \times VLDH_gain + VLDH_offset$
VLDL_	$(V_{DAC} - DGS) \times (20mA/6V) \times VLDL_gain + VLDL_offset$
VIOS	$((V_{DAC} + DGS)/2) \times VIOS_gain + VIOS_offset$
IIOS	$((V_{DAC} + REF)/2) \times IIOS_gain + IIOS_offset$
VHH_	$(V_{DAC} - DGS) \times 2 \times VHH_gain + VHH_offset + DGS$
CLAMPHI_ (Voltage)	$V_{DAC} \times CLAMPHI_gain + CLAMPHI_offset$
CLAMPHI_ (Current)	$(V_{DAC} - V_{ILOS}) \times FSR/2V \times CLAMPHI_gain + CLAMPHI_offset$
CLAMPLO_ (Voltage)	$V_{DAC} \times CLAMPLO_gain + CLAMPLO_offset$
CLAMPLO_ (Current)	$(V_{DAC} - V_{ILOS}) \times FSR/2V \times CLAMP_LO_gain + CLAMPLO_offset$

- Values for PMU_FI_gain and PMU_FI_offset are different for each PMU current range.
- VLDH_ and VLDL_ levels less than zero are truncated.
- Full-scale range is dependent upon the PMU current range. Values are 100mA, 4mA, 400µA, 40µA, and 4µA for ranges A–E, respectively.
- Values for CLAMPHI_gain, CLAMPLO_gain, CLAMPHI_offset, and CLAMPLO_offset vary with PMU force mode and current range.

The V_{DAC} voltages are then utilized for the various signal paths within the MAX9979 (i.e., driver level DHV_). Each of these signal paths have inherent gain and offset errors, denoted as _gain and _offset terms in the Level Transfer Function column in Table 23. These error terms are presented to convey the non-ideal gain and offset of the signal paths—they do not have a specified value. The GAINCODE and OFFSETCODE features of each DAC are designed to correct for these errors to make the level transfer function expressions, and therefore, the final signal path outputs (e.g., DHV_) more ideal.

Pin Configuration

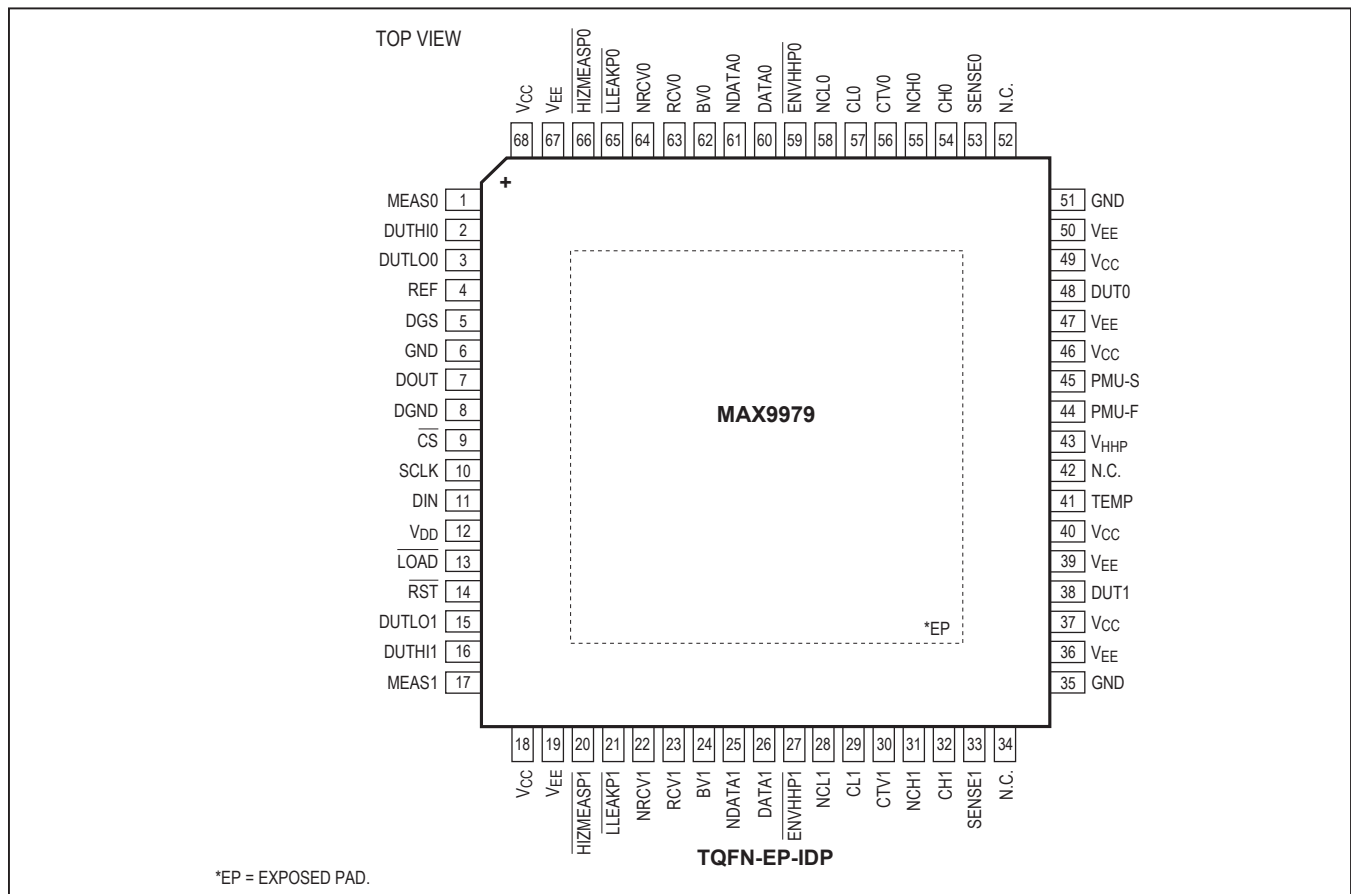

Applications Information

Device Power-Up State

Upon power-up, the DCL enters low-leak mode and the PMU enters high-impedance mode. The DCL control, DCL calibration, and PMU control registers default to 0x0004, 0x0008, and 0x0003, respectively. For initial power-up values for the level-setting registers, see Table 20. Power supplies may be powered on in any sequence.

Power-Supply Considerations

Bypass each supply input to GND and REF to DGS with 0.1µF capacitors (Figure 13). Additionally, use bulk bypassing of at least 10µF where the power-supply connections meet the circuit board.

Exposed Pad

The exposed pad is internally connected to ground. Connect to an open copper PCB ground plane or heatsink to maximize thermal performance. Not intended as an electrical connection point.

Typical Operating Circuit

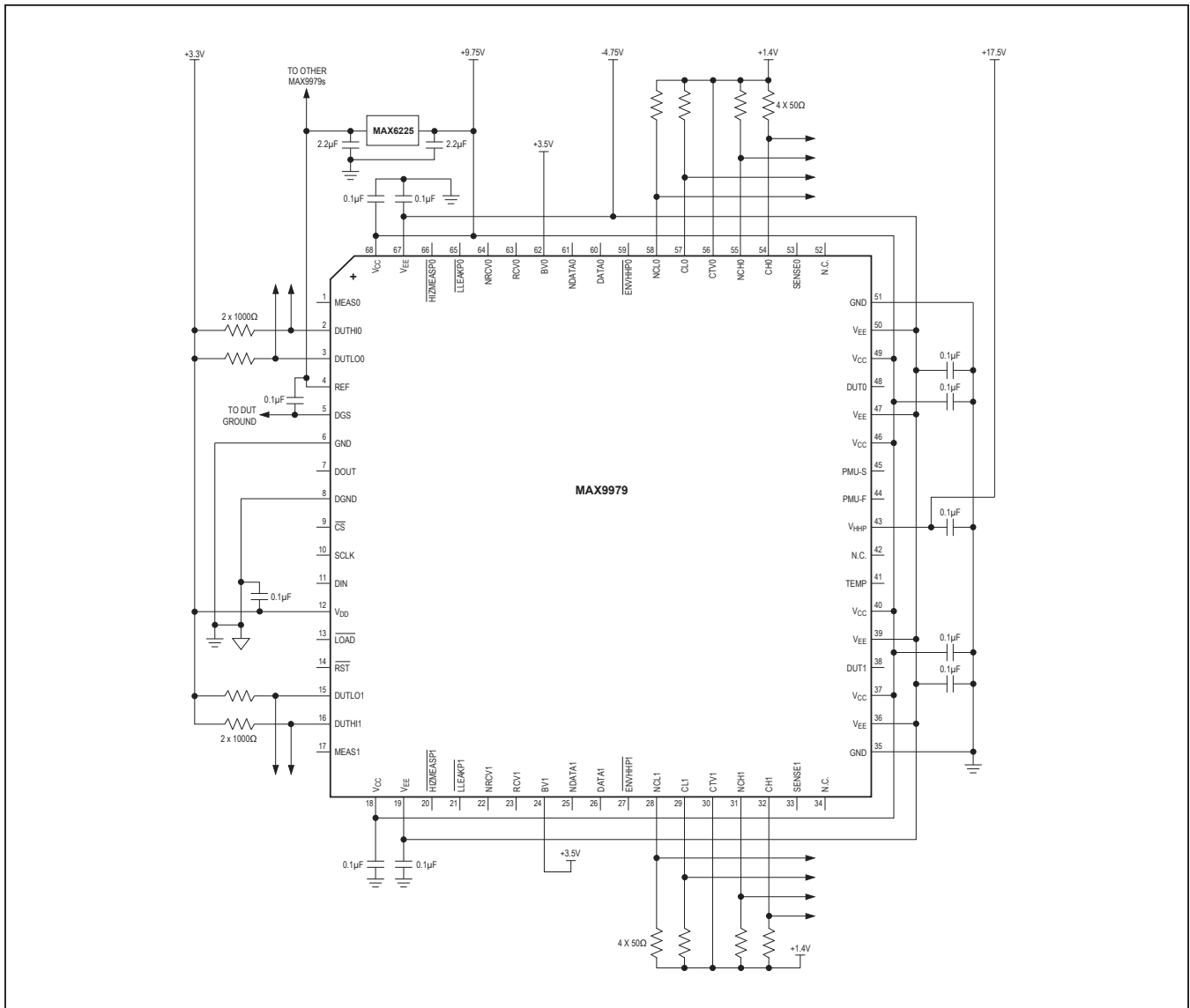

Chip Information

PROCESS: BiCMOS

Package Information

For the latest package outline information and land patterns (footprints), go to www.maximintegrated.com/packages. Note that a "+", "#", or "-" in the package code indicates RoHS status only. Package drawings may show a different suffix character, but the drawing pertains to the package regardless of RoHS status.

PACKAGE TYPE	PACKAGE CODE	OUTLINE NO.	LAND PATTERN NO.
68 TQFN-EP-IDP	T6800RN+6	21-0192	90-0090

Revision History

REVISION NUMBER	REVISION DATE	DESCRIPTION	PAGES CHANGED
0	6/08	Initial release	—
1	10/08	Corrected error in Table 2 and formula on page 57	36, 57
2	12/08	Added new Tables 6 and 7 and renumbered subsequent tables	37, 38, 41, 42, 44, 45, 46, 48, 50–54, 56, 57, 58
3	4/09	Made spec changes and clarifications	5–8, 20, 57
4	6/09	Corrected <i>Typical Operating Circuit</i>	59, 42
5	1/11	Updated <i>Pin Description</i> , <i>Exposed Pad</i> section, and <i>Package Information</i>	33, 58, 59
6	8/11	Clarified use of exposed die attach pad	33, 58
7	5/19	Updated Table 2 and Table 9	36, 42

For pricing, delivery, and ordering information, please visit Maxim Integrated's online storefront at <https://www.maximintegrated.com/en/storefront/storefront.html>.

Maxim Integrated cannot assume responsibility for use of any circuitry other than circuitry entirely embodied in a Maxim Integrated product. No circuit patent licenses are implied. Maxim Integrated reserves the right to change the circuitry and specifications without notice at any time. The parametric values (min and max limits) shown in the Electrical Characteristics table are guaranteed. Other parametric values quoted in this data sheet are provided for guidance.