



Is Now Part of



**ON Semiconductor®**

To learn more about ON Semiconductor, please visit our website at  
[www.onsemi.com](http://www.onsemi.com)

Please note: As part of the Fairchild Semiconductor integration, some of the Fairchild orderable part numbers will need to change in order to meet ON Semiconductor's system requirements. Since the ON Semiconductor product management systems do not have the ability to manage part nomenclature that utilizes an underscore (\_), the underscore (\_) in the Fairchild part numbers will be changed to a dash (-). This document may contain device numbers with an underscore (\_). Please check the ON Semiconductor website to verify the updated device numbers. The most current and up-to-date ordering information can be found at [www.onsemi.com](http://www.onsemi.com). Please email any questions regarding the system integration to [Fairchild\\_questions@onsemi.com](mailto:Fairchild_questions@onsemi.com).

ON Semiconductor and the ON Semiconductor logo are trademarks of Semiconductor Components Industries, LLC dba ON Semiconductor or its subsidiaries in the United States and/or other countries. ON Semiconductor owns the rights to a number of patents, trademarks, copyrights, trade secrets, and other intellectual property. A listing of ON Semiconductor's product/patent coverage may be accessed at [www.onsemi.com/site/pdf/Patent-Marking.pdf](http://www.onsemi.com/site/pdf/Patent-Marking.pdf). ON Semiconductor reserves the right to make changes without further notice to any products herein. ON Semiconductor makes no warranty, representation or guarantee regarding the suitability of its products for any particular purpose, nor does ON Semiconductor assume any liability arising out of the application or use of any product or circuit, and specifically disclaims any and all liability, including without limitation special, consequential or incidental damages. Buyer is responsible for its products and applications using ON Semiconductor products, including compliance with all laws, regulations and safety requirements or standards, regardless of any support or applications information provided by ON Semiconductor. "Typical" parameters which may be provided in ON Semiconductor data sheets and/or specifications can and do vary in different applications and actual performance may vary over time. All operating parameters, including "Typicals" must be validated for each customer application by customer's technical experts. ON Semiconductor does not convey any license under its patent rights nor the rights of others. ON Semiconductor products are not designed, intended, or authorized for use as a critical component in life support systems or any FDA Class 3 medical devices or medical devices with a same or similar classification in a foreign jurisdiction or any devices intended for implantation in the human body. Should Buyer purchase or use ON Semiconductor products for any such unintended or unauthorized application, Buyer shall indemnify and hold ON Semiconductor and its officers, employees, subsidiaries, affiliates, and distributors harmless against all claims, costs, damages, and expenses, and reasonable attorney fees arising out of, directly or indirectly, any claim of personal injury or death associated with such unintended or unauthorized use, even if such claim alleges that ON Semiconductor was negligent regarding the design or manufacture of the part. ON Semiconductor is an Equal Opportunity/Affirmative Action Employer. This literature is subject to all applicable copyright laws and is not for resale in any manner.



# FPF2700 / FPF2701 / FPF2702 — AccuPower™ 0.4~2 A Adjustable Over-Current Protection Load Switches

## Features

- 2.8 V to 36 V Input Voltage Range
- Typical  $R_{DS(ON)}=88\text{ m}\Omega$
- 0.4 A to 2 A Adjustable Current Limit (Min.)
- Slew Rate Controlled
- ESD Protected, above 2000 V HBM
- Thermal Shutdown
- Active LOW Enable
- UVLO Protection
- Power-Good Output

## Applications

- Motor Drives
- Digital Cameras
- Consumer Electronics
- Industrial
- Computing
- Hard Disk Drives
- Telecom Equipment



Figure 1. MLP (Top View) Figure 2. MLP (Bottom View)

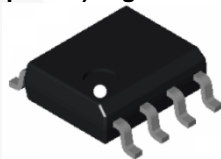

Figure 3. SO8 (Top View)

## Description

The AccuPower™ FPF270X series is a family of current-limit load switches that provide full protection to systems and loads from excess current conditions. Minimum current limit is adjustable from 0.4 A to 2.0 A. The FPF270X contains a slew-rate-controlled N-channel MOSFET and slew-rated turn-on to prevent power bus disturbances from being caused by “hot plugging” loads or momentary excess load demands. The input voltage range is 2.8 V to 36 V. Loads can be activated or deactivated with a low-voltage logic-compatible ON pin. Fault conditions can be monitored using the error flag pin and/or the power-good pin.

Each member of the FPF270X family serves a category of load-fault response. All devices clamp the load current so that it cannot exceed an externally programmed current level. An over temperature feature provides further device protection in case of excessive levels of power dissipation.

FPF2700 responds to an overload condition that lasts longer than a fixed blanking period by turning off the load, followed by a retry after the auto-restart time.

FPF2701 responds to an overload condition that lasts longer than a fixed blanking period by latching off the load. The load remains off unless either the ON pin is toggled or the input voltage cycles through UVLO.

FPF2702 is intended to be used with external fault management. Like the FPF2700 and FPF2701, it sets the fault signal pin LOW when it activates current clamping. This device is intended for applications where external fault management coordinates the overload response with the FPF2702.

The FPF270X is available in a space-saving, Lead and Halogen free, 8-lead, MLP 3x3 mm and SO8 packages.

## Ordering Information

Part Number	Current Limit [A]	Current Limit Blanking Time [ms]	Auto-Restart Time [ms]	ON Pin Activity	Package
FPF2700MPX	0.4 – 2.0	0.5	127.5	Active LOW	MLP3X3
FPF2701MPX	0.4 – 2.0	0.5	NA	Active LOW	MLP3X3
FPF2702MPX	0.4 – 2.0	NA	NA	Active LOW	MLP3X3
FPF2700MX	0.4 – 2.0	0.5	127.5	Active LOW	SO8
FPF2701MX	0.4 – 2.0	0.5	NA	Active LOW	SO8
FPF2702MX	0.4 – 2.0	NA	NA	Active LOW	SO8

### Application Diagram

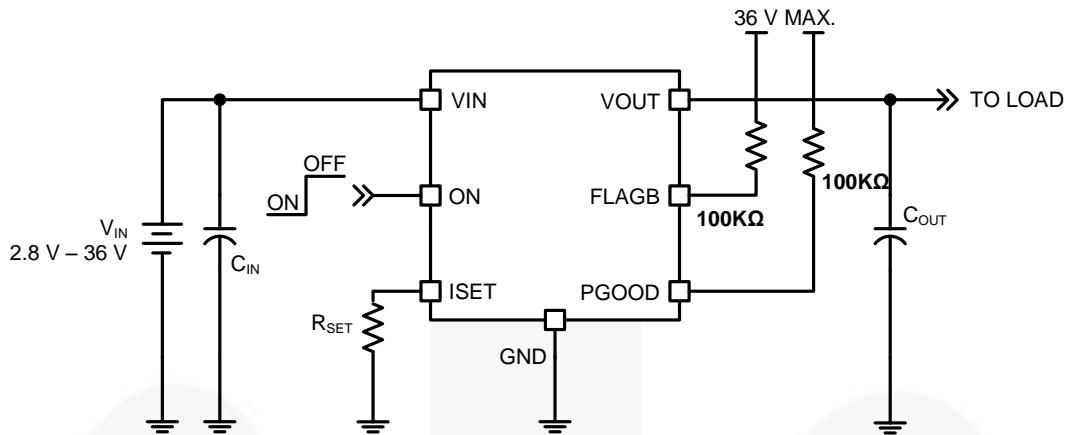

Figure 4. Typical Application

### Block Diagram

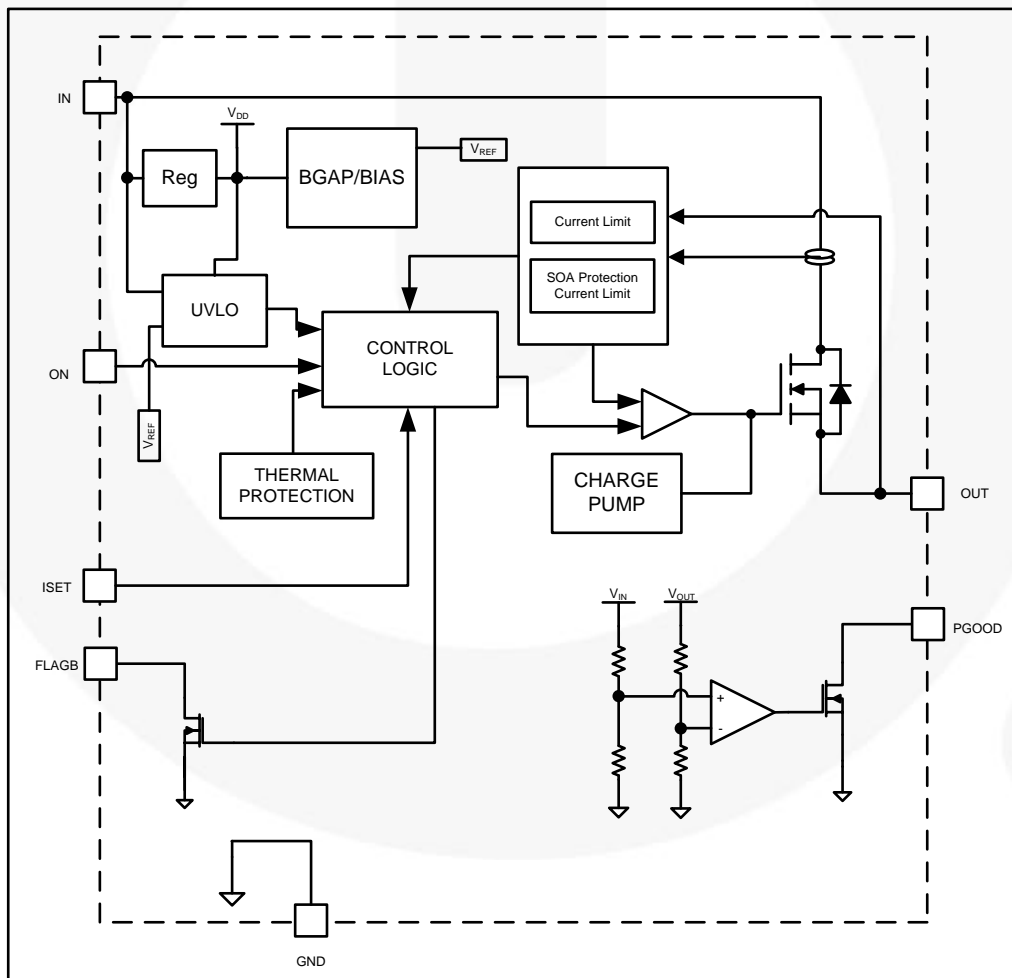

Figure 5. Block Diagram

## Pin Configurations

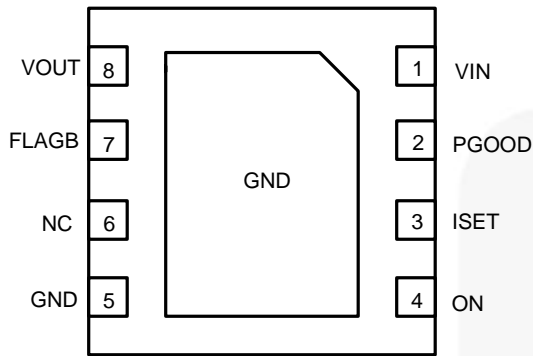

Figure 6. MLP (Bottom View)

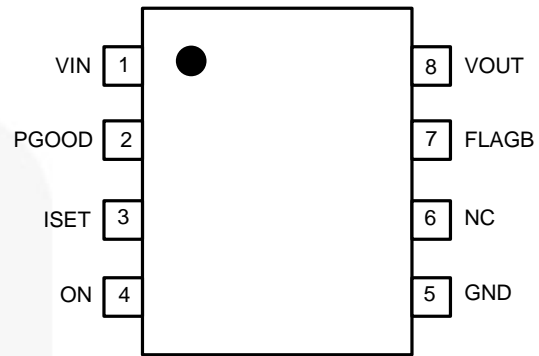

Figure 7. SO8 (Top View)

## Pin Definitions

Pin #	Name	Description
1	VIN	Supply Input. Input to the power switch and the supply voltage for the IC.
2	PGOOD	Power-Good Output. Open-drain output to indicate that output voltage has reached 90% of input voltage.
3	ISET	Current Limit Set Input. A resistor from ISET to ground sets the current limit for the switch.
4	ON	ON Control Input. Active LOW.
5	GND	Ground
6	NC	No connection. Leave open or connect to ground.
7	FLAGB	Fault Output. Active LOW, open-drain output that indicates current limit, under-voltage, or over-temperature state.
8	VOUT	Switch Output. Output of the power switch.

## Absolute Maximum Ratings

Stresses exceeding the absolute maximum ratings may damage the device. The device may not function or be operable above the recommended operating conditions and stressing the parts to these levels is not recommended. In addition, extended exposure to stresses above the recommended operating conditions may affect device reliability. The absolute maximum ratings are stress ratings only.

Symbol	Parameter	Min.	Max.	Unit
	PGOOD, FLAGB, VIN to GND	-0.3	40	V
	VOUT to GND	-0.3	V <sub>IN</sub> + 0.3	V
	ON to GND	-0.3	6	V
P <sub>D</sub>	Power Dissipation (T <sub>A</sub> =25°C)	MLP 3x3 <sup>(1)</sup> , See Figure 8	1.25	W
		SO8 <sup>(1)</sup> , See Figure 10	1.00	
I <sub>SW</sub>	Maximum Continuous Switch Current		3.5	A
T <sub>J</sub>	Operating Junction Temperature	-40	+125	°C
T <sub>STG</sub>	Storage Temperature	-65	+150	°C
ESD	Electrostatic Discharge Protection Level	Human Body Model, JESD22-A114	2000	V
		Charged Device Model, JESD22-C101	2000	
θ <sub>JA</sub>	Thermal Resistance, Junction to Ambient	MLP 3x3 <sup>(1)</sup> , See Figure 8	80	°C/W
		SO8 <sup>(1)</sup> , See Figure 10	102	

### Note:

- Thermal resistance, θ<sub>JA</sub>, is determined with the device mounted on a one inch square pad, 2 oz copper pad, and a 1.5 x 1.5 in. board of FR-4 material.

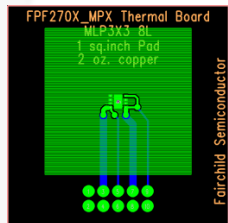

Figure 8. 80°C/W Mounted on a 1in<sup>2</sup> Pad of 2-oz. Copper

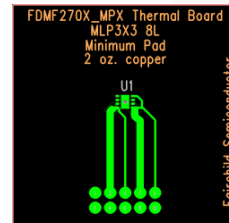

Figure 9. 226°C/W Mounted on a Minimum Pad of 2-oz. Copper

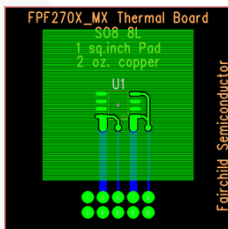

Figure 10. 102°C/W mounted on a 1in<sup>2</sup> Pad of 2-oz. Copper

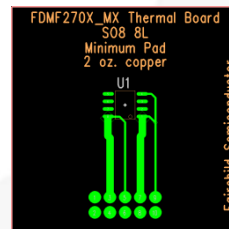

Figure 11. 181°C/W Mounted on a Minimum Pad of 2-oz. Copper

## Recommended Operating Conditions

The Recommended Operating Conditions table defines the conditions for actual device operation. Recommended operating conditions are specified to ensure optimal performance. Fairchild does not recommend exceeding them or designing to Absolute Maximum Ratings.

Symbol	Parameter	Min.	Max.	Unit
V <sub>IN</sub>	Input Supply Voltage	2.8	36.0	V
T <sub>A</sub>	Ambient Operating Temperature	-40	85	°C

## Electrical Characteristics

$V_{IN}$ =2.8 to 36 V and  $T_A$ =-40 to +85°C unless otherwise noted. Typical values are at  $V_{IN}$ =12 V and  $T_A$ =25°C.

Symbol	Parameter	Conditions	Min.	Typ.	Max.	Unit
<b>Basic Operation</b>						
$V_{IN}$	Operating Voltage		2.8		36.0	V
$I_Q$	Quiescent Current	$V_{IN}=12\text{ V}$ , $V_{ON}=0\text{ V}$ , $I_{OUT}=0\text{ A}$		92	140	$\mu\text{A}$
$I_{SHDN}$	Shutdown Current	$V_{IN}=36\text{ V}$ , $V_{ON}=3.3\text{ V}$ , $I_{OUT}=0\text{ A}$		5	14	$\mu\text{A}$
$R_{ON}$	On Resistance	$T_A=25^\circ\text{C}$ , $V_{IN}=12\text{ V}$		88	114	m $\Omega$
		$T_A=-40\text{ to }+85^\circ\text{C}$ , $V_{IN}=12\text{ V}$			140	
		$T_A=25^\circ\text{C}$ , $V_{IN}=5\text{ V}$		88	114	
		$T_A=-40\text{ to }+85^\circ\text{C}$ , $V_{IN}=5\text{ V}$			140	
$V_{IH}$	ON Input Logic HIGH Voltage	$V_{IN}=2.8\text{ to }36\text{ V}$	2.0			V
$V_{IL}$	ON Input Logic LOW Voltage	$V_{IN}=2.8\text{ to }36\text{ V}$			0.8	V
$I_{LK}$	ON Input Leakage	$V_{ON}=5.5\text{ V}$ or GND	-1		1	$\mu\text{A}$
$I_{SWOFF}$	Off Switch Leakage	$V_{IN}=36\text{ V}$ , $V_{ON}=3.3\text{ V}$ , $V_{OUT}=0\text{ V}$		0.01		$\mu\text{A}$
$V_{FLAGB(LO)}$	FLAGB Output Logic LOW Voltage	$V_{IN}=5\text{ V}$ , $I_{SINK}=1\text{ mA}$		0.1	0.2	V
$I_{FLAGB(HI)}$	FLAGB Output Logic HIGH Leakage Current	$V_{IN}=36\text{ V}$ , Switch On, $V_{FLAGB}=36\text{ V}$			1	$\mu\text{A}$
$V_{PGOOD}$	PGOOD Trip Voltage	$V_{IN}=5\text{ V}$ , $V_{OUT}$ as Percent of $V_{IN}$ , $V_{OUT}$ Rising		90		%
$V_{PGOOD(HYS)}$	PGOOD Hysteresis	$V_{IN}=5\text{ V}$ , $V_{OUT}$ as Percent of $V_{IN}$ , $V_{OUT}$ Falling		3		%
$V_{PGOOD(LO)}$	PGOOD Output Logic LOW Voltage	$V_{IN}=5\text{ V}$ , $I_{SINK}=1\text{ mA}$		0.1	0.2	V
$I_{PGOOD(HI)}$	PGOOD Output High Leakage Current	$V_{IN}=36\text{ V}$ , Switch ON, $V_{PGOOD}=36\text{ V}$			1	$\mu\text{A}$
<b>Protections</b>						
$I_{LIM}$	Current Limit	$T_A=25^\circ\text{C}$	-20		+20	%
$I_{SC}$	Short Circuit Current Limit	$V_{OUT} < 2\text{ V}$ , Switch in Over-Current Condition		$0.75 \times I_{NOM}$		A
TSD	Thermal Shutdown	Shutdown Threshold		140		$^\circ\text{C}$
		Return from Shutdown		110		
		Hysteresis		30		
UVLO	Under-Voltage Shutdown	$V_{IN}$ Increasing	2.3	2.5	2.7	V
UVLO_HYST	Under-Voltage Shutdown Hysteresis			100		mV
<b>Dynamic</b>						
$t_{don}$	Turn On Delay	$R_L=500\ \Omega$ , $C_L=2\ \mu\text{F}$		2.7		ms
$t_{doff}$	Turn Off Delay			0.1		
$t_R$	$V_{OUT}$ Rise Time			7.5		
$t_F$	$V_{OUT}$ Fall Time			1.5		
$t_{BLANK}$	Over-Current Blanking Time	FPF2700/1, $T_A=25^\circ\text{C}$	0.25	0.50	0.75	ms
$t_{RESTART}$	Auto-Restart Time	FPF2700, $T_A=25^\circ\text{C}$	63.8	127.5	191.2	ms
$t_{CLR}$	Current-Limit Response Time	$V_{IN}=12\text{ V}$ , $V_{ON}=0\text{ V}$		50		$\mu\text{s}$

### Timing Diagram

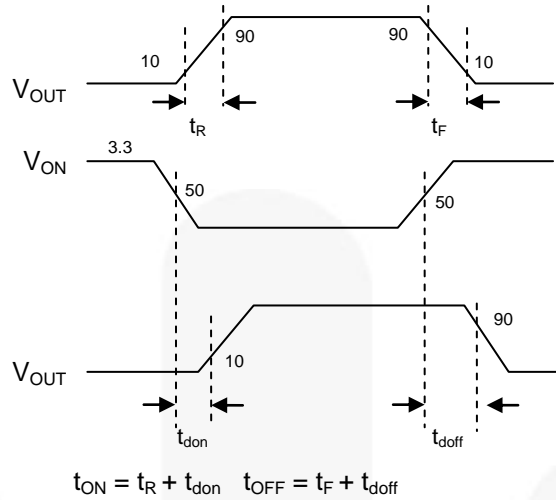

Figure 12. Timing Diagram

### Typical Performance Characteristics

$V_{IN} = 12\text{ V}$  and  $T_A = 25^\circ\text{C}$ .

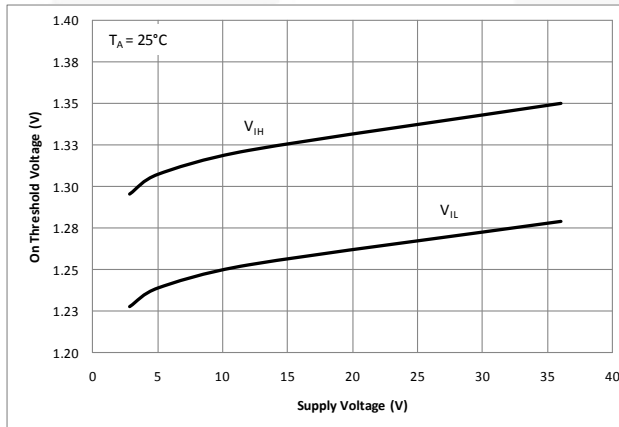

Figure 13. ON Threshold vs. Supply

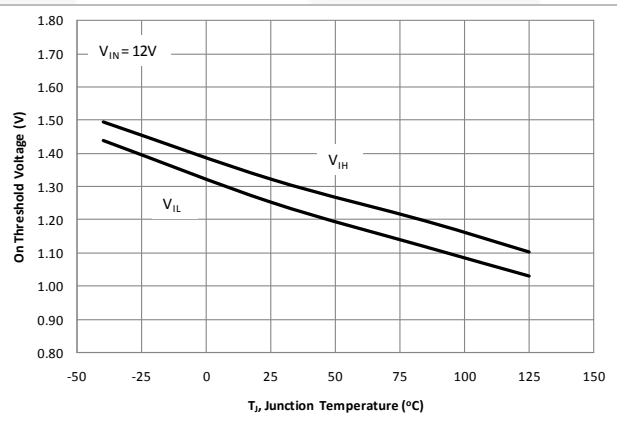

Figure 14. ON Threshold vs. Temperature

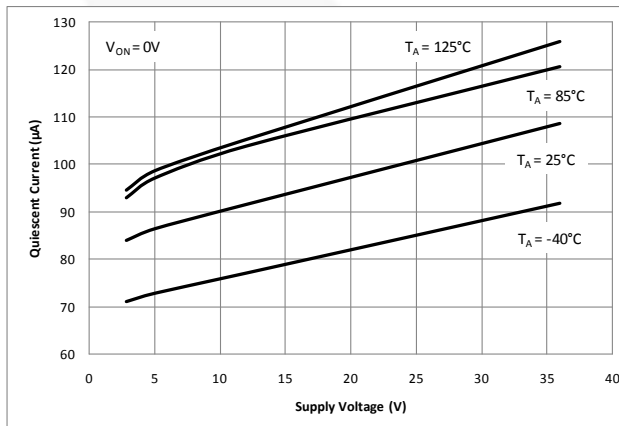

Figure 15. Quiescent Current vs. Supply Voltage (ON)

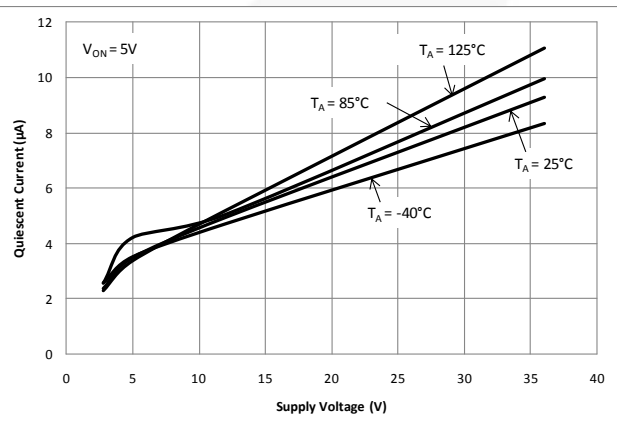

Figure 16. Quiescent Current vs. Supply Voltage (OFF)

## Typical Performance Characteristics

$V_{IN} = 12\text{ V}$  and  $T_A = 25^\circ\text{C}$ .

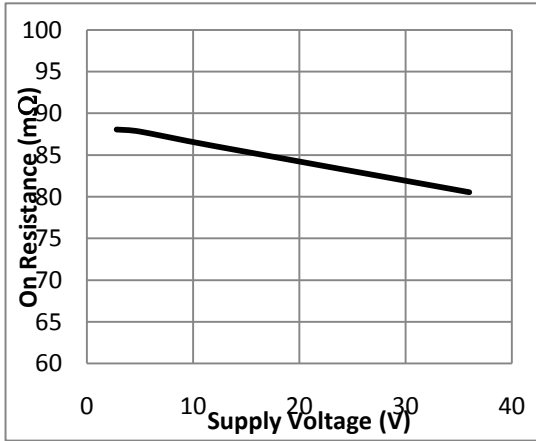

Figure 17. On Resistance vs. Supply Voltage

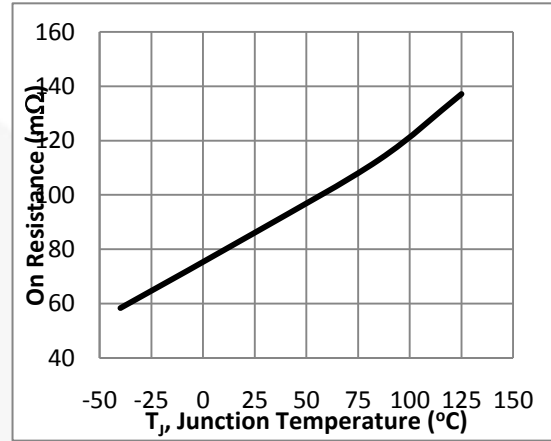

Figure 18. On Resistance vs. Junction Temperature

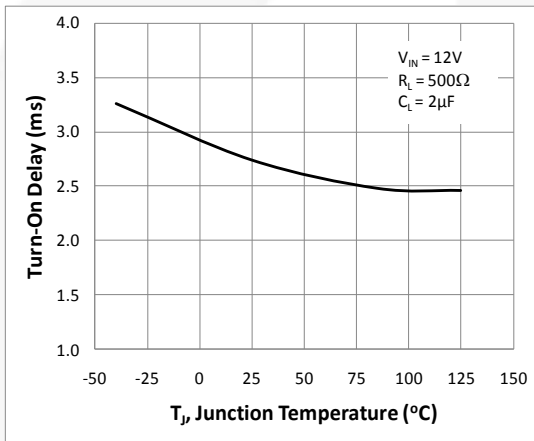

Figure 19. Turn-On Delay vs. Junction Temperature

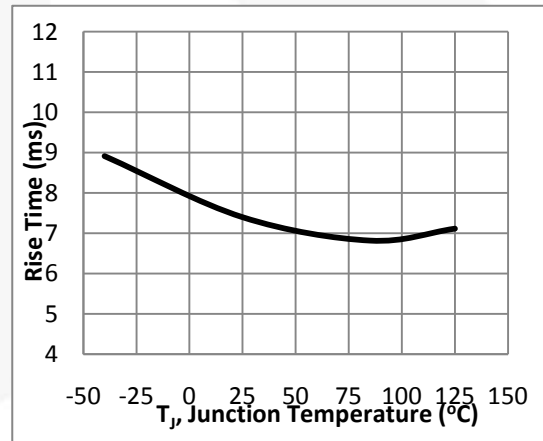

Figure 20. Output Rise Time vs. Junction Temperature

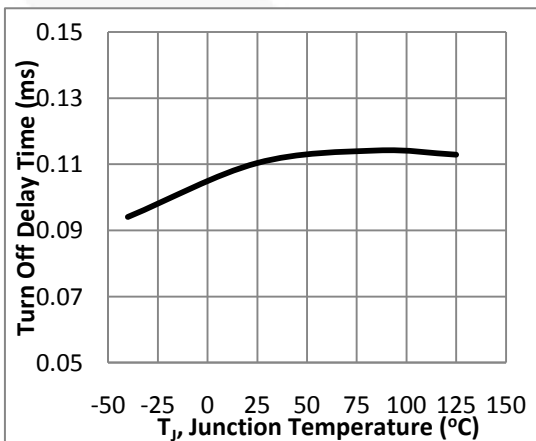

Figure 21. Turn-Off Delay vs. Junction Temperature

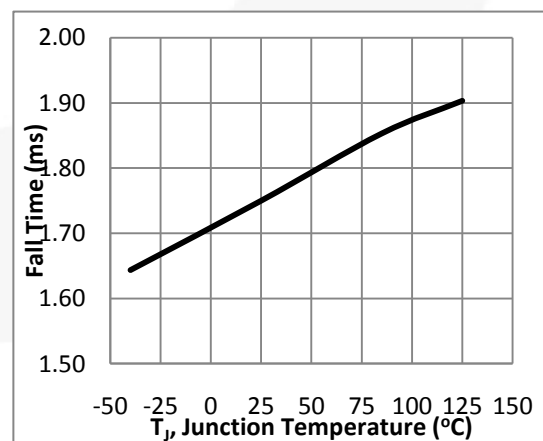

Figure 22. Output Fall Time vs. Junction Temperature



## Typical Operation Characteristics of FPF2700 and FPF2701

When  $V_{OUT} < 2V$ , the current limit is set to 75% of  $I_{LIM}$ .

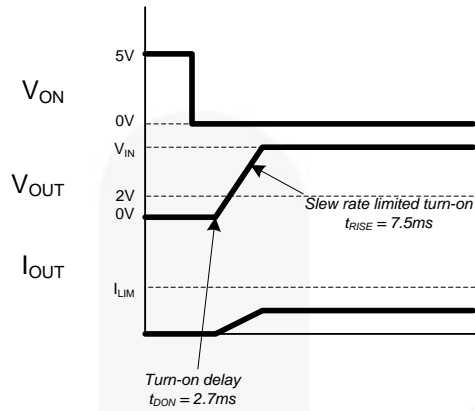

Figure 23. Normal Startup to  $0.5X I_{LIM}$

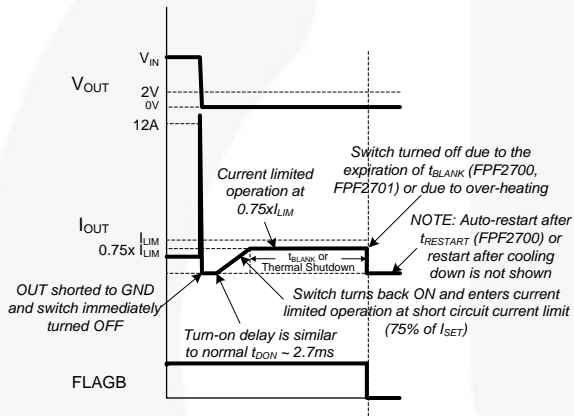

Figure 24. OUT Shorted to GND, Short Condition Persists (SOA Protection Followed by Current-Limited Operation)

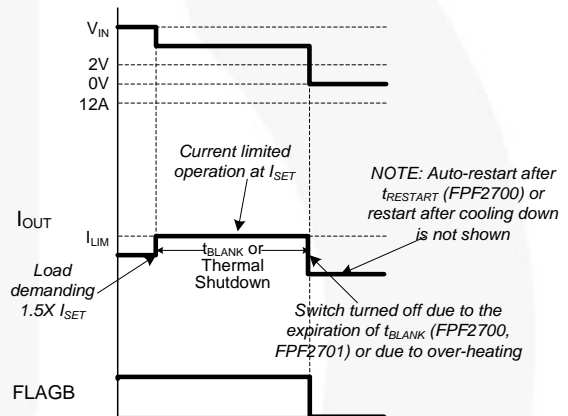

Figure 25. OUT Overloaded with  $1.5X I_{LIM}$  (Long-Duration Overload)

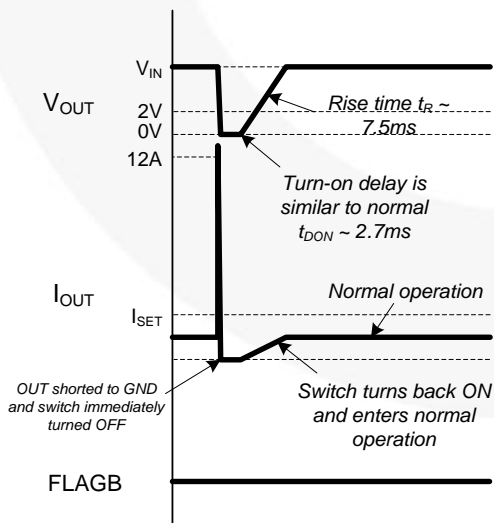

Figure 26. OUT Shorted to GND, Short Condition Removed (SOA Protection Followed by Normal Operation)

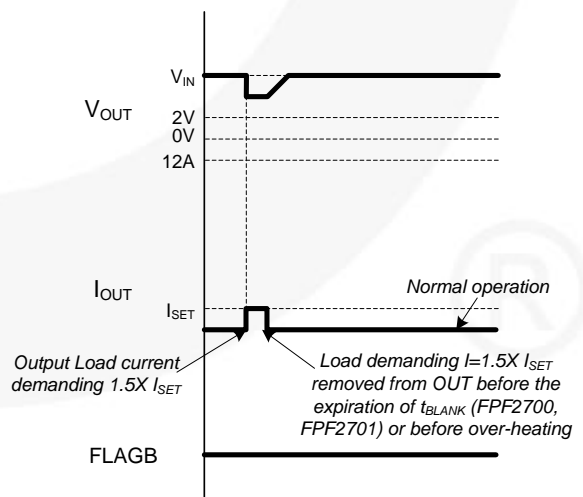
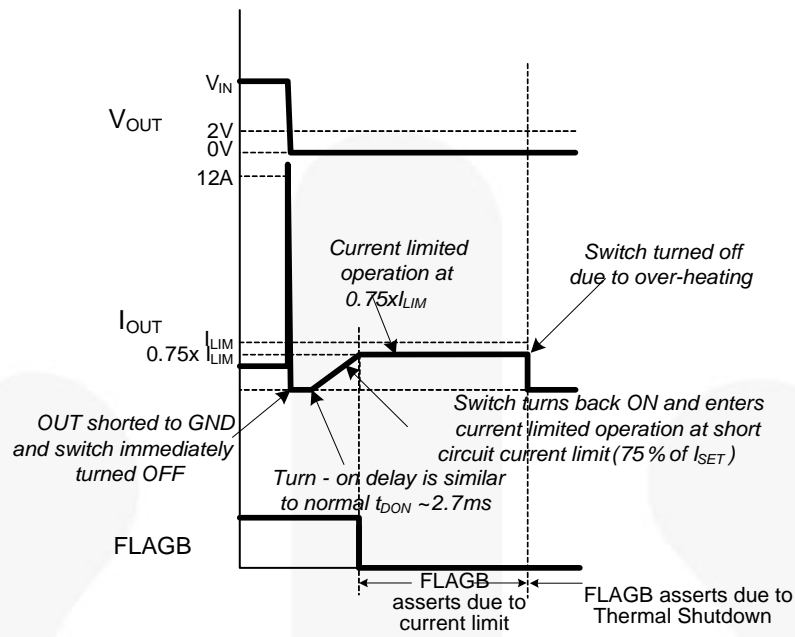
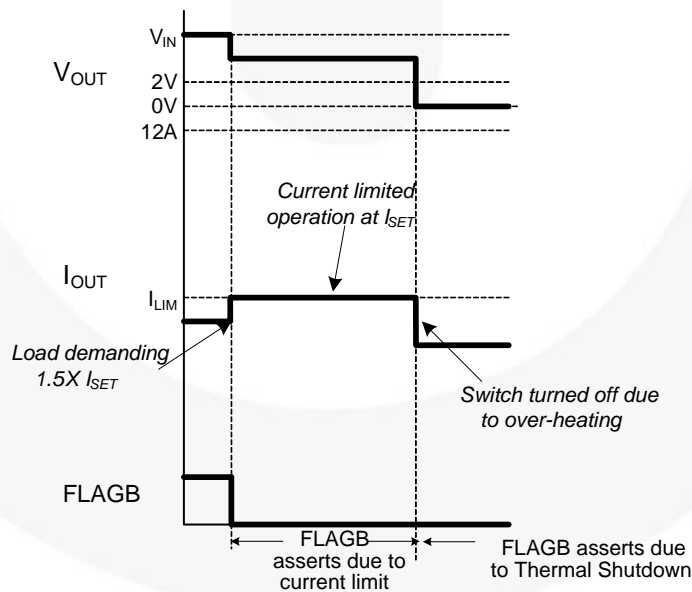

Figure 27. OUT Overloaded with  $1.5X I_{LIM}$  (Transient Overload)

### Typical Operation Characteristics of FPF2702



**Figure 28. OUT Shorted to GND, Short Condition Persists (SOA Protection Current Limit Followed by Current Limit)**



**Figure 29. OUT Overloaded with  $1.5 \times I_{LIM}$  (Long-Duration Overload)**

## Typical Performance Characteristics FPF270X

$V_{IN} = 12\text{ V}$  and  $T_A = 25^\circ\text{C}$ .

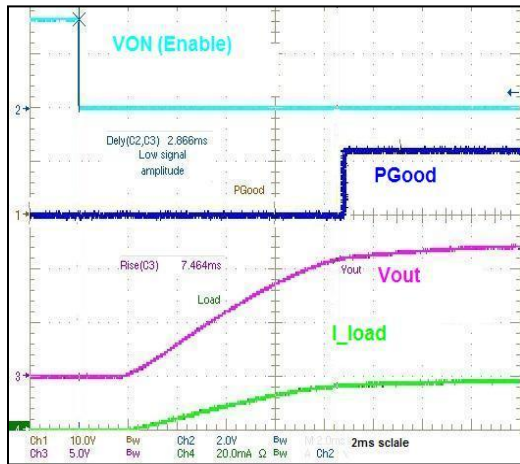

Figure 30. 12V Turn-On Delay ( $R_L=500\ \Omega$ ,  $C_{OUT}=2\ \mu\text{F}$ )

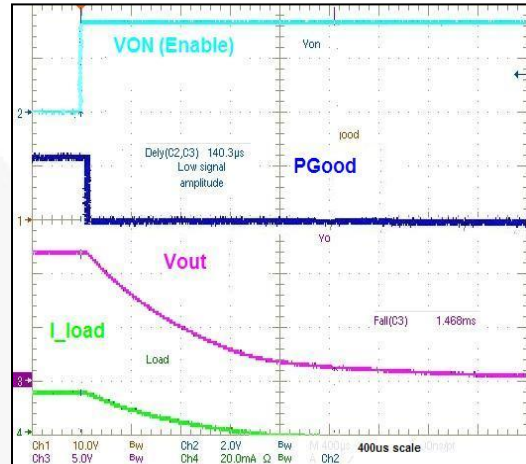

Figure 31. 12V Turn-Off Delay ( $R_L=500\ \Omega$ ,  $C_{OUT}=2\ \mu\text{F}$ )

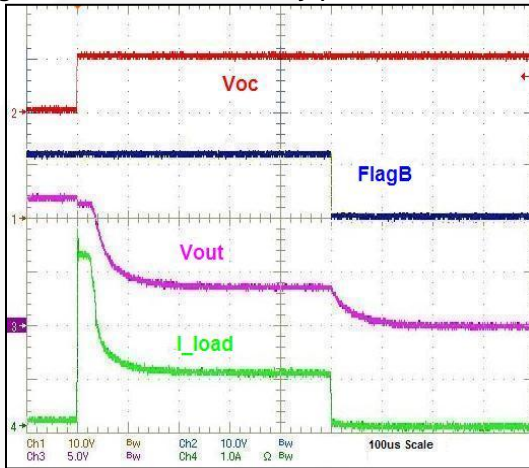

Figure 32. 12V Blanking Time (Output Overloaded and  $t_{blank}$  Expired, FPF2700/01,  $I_{LIM}=1\text{ A}$ ,  $I_{LOAD}=3.3\text{ A}$ ,  $C_{OUT}=\mu\text{F}$ ,  $R_{LOAD}=500\ \Omega$ )  $V_{OC}^{(2)}$

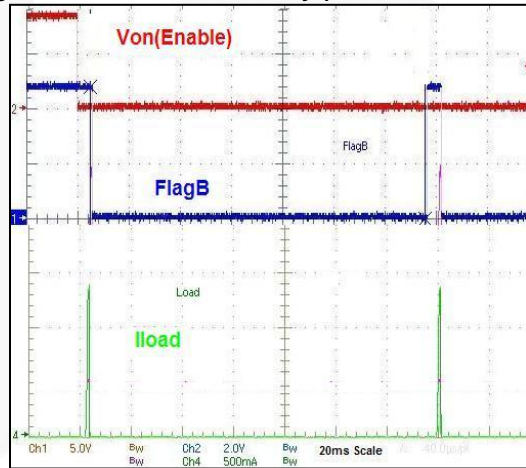

Figure 33. 12V Restart Time (Switch Turned ON into Persistent Over-Current Condition,  $t_{RESTART}\sim 127.5\text{ ms}$ )

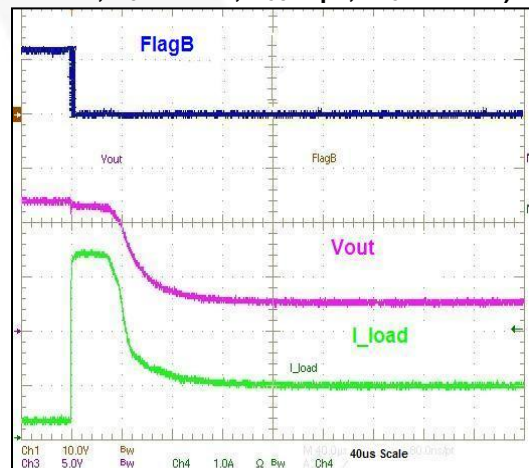

Figure 34. Soft Overload and Constant Current ( $I_{LOAD} > I_{LIM}$ , FPF2702 Enters Constant Current Mode, Running at  $I_{LIM}$ )

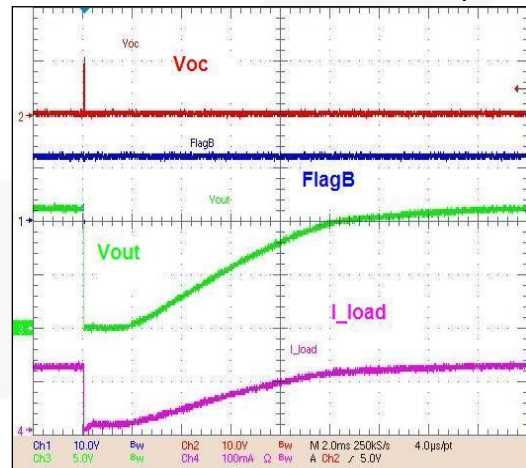

Figure 35. OUT Shorted to GND, Short Condition Removed (SOA Protection Followed by a Normal Operation, FPF2700 / FPF2701)

**Note:**

- $V_{OC}$  signal forces the device into an over-current condition by loading a  $500\text{ m}\Omega$  resistor to the output through an NMOS.  $V_{OC}$  is the gate drive of the NMOS.

## Application Information

### Description of Operation

The FPF270X family of current limit load switches is designed to meet the power requirements of a variety of applications with wide input voltage range of 2.8 V to 36 V and adjustable current-limit value. The FPF270X family offers control and protection while providing optimum operation current for safe design practices. The core of each switch is a typical 88 mΩ ( $V_{IN} = 12\text{ V}$ ) N-channel MOSFET and a controller capable of functioning over an input voltage range of 2.8 V to 36 V.

FPF270X offers adjustable current limiting, under-voltage lockout (UVLO), power-good indicator (PGOOD), fault flag output (FLAGB), and thermal shutdown protection. In the event of an over-current condition, the load switch limits the load to the current limit value. The current limit value for each switch can be adjusted from 400 mA to 2 A through the ISET pin.

### On/Off Control

The ON pin is active LOW for and controls the state of the switch. Pulling the ON pin continuously to LOW holds the switch in ON state. The switch moves into OFF state when the ON pin is pulled HIGH. The ON pin can be pulled HIGH to a maximum voltage of 5.5 V.

An under-voltage condition on the input voltage or a junction temperature in excess of 140°C overrides the ON control and turns off the switch. In addition, an over-current condition causes the switch to turn off in the FPF2700 and FPF2701 after the expiration of the blanking time. The FPF2700 has an auto-restart feature that automatically turns the switch ON again after the auto-restart time. For the FPF2701, the ON pin must be toggled to turn the switch on again. The FPF2702 does not turn off in response to an over-current condition; it remains operating in Constant-Current Mode as long as ON is enabled and the thermal shutdown or UVLO have not activated. The ON pin does not have internal pull-down or pull-up resistors and should not be left floating.

### Fault Reporting

Upon detection of an over-current condition, an input UVLO, or an over-temperature condition, the FLAGB signals the Fault Mode by activating LOW. In the event of an over-current condition for the FPF2700 or FPF2701, the FLAGB goes LOW at the end of the blanking time (Figure 24 and Figure 25). FLAGB goes LOW immediately for the FPF2702 (Figure 29). If the over-current condition lasts longer than blanking time, FLAGB remains LOW through the auto-restart time for the FPF2700. For the FPF2701, FLAGB is latched LOW and ON must be toggled to release it.

For FPF2702, FLAGB is LOW during a fault and immediately returns HIGH at the end of the fault condition. FLAGB is an open-drain MOSFET that requires a pull-up resistor. The maximum pull-up voltage is 36 V (Figure 29).

During shutdown, the pull-down on FLAGB is disabled to reduce current draw from the supply. A 100 kΩ pull-up resistor is recommended in the application.

### Current Limiting

The current limit ensures that the current through the switch doesn't exceed a maximum value while not limiting at less than a minimum value. The current-limit level is adjustable through an external resistor connected between the ISET pin and GND.

The typical current limit level is adjustable from 510 mA to 2.5 A. The minimum current limit ( $I_{LIM(MIN)}$ ) range is from 0.4 A to 2.0 A, including 20% current-limit tolerance. The FPF2700 and FPF2701 have a blanking time during which the switch acts as a constant-current source (Figure 27). If the over-current condition persists beyond the blanking time, the FPF2700 latches off and shuts the switch off (Figure 32). If the ON pin is kept active, an auto-restart feature releases the switch and turns the switch on again after the auto-restart time (Figure 33). If the over-current condition persists beyond the blanking time, the FPF2701 latch-off feature shuts the switch off. The switch is kept off until the ON pin is toggled or input power is cycled. The FPF2702 has no current-limit blanking period, so it remains in a constant-current state until the ON pin is deactivated or the thermal shutdown turns off the switch.

Besides the current-limiting functionality, the switch is protected by the thermal shutdown protection and an independent SOA protection circuit is available.

### SOA Protection Current Limit ( $I_{OUT} > 12\text{ A}$ )

FPF270X has an SOA protection feature to protect the load switch in response to current surges exceeding 12 A in normal operation. If a short-circuit event occurs ( $I_{OUT} > 12\text{ A}$ ), the switch is turned off in about 1 μs by an independent Safe Operating Area (SOA) protection circuit (Figure 26, Figure 28). This feature protects the switch in case of sudden, high-current events at the output, such as a short to GND. The switch turns on automatically after a turn-on delay of about 2.7 ms.

### Short-Circuit Current Limit ( $V_{OUT} < V_{SCTH} = 2\text{ V}$ )

When the output voltage drops below the short-circuit threshold voltage,  $V_{SCTH}$ , the current-limit value re-conditions itself to the short-circuit current limit value, which is 75% of the nominal current limit ( $0.75 \times I_{LIM}$ ) (Figure 24). This prevents early thermal shutdown by reducing the power dissipation of the device. The  $V_{SCTH}$  value is set at 2 V. At about  $V_{OUT} = 2.1\text{ V}$ , the switch is removed from short-circuit current-limiting mode and the current limit is set to the nominal current limit value.

### Setting the Current Limit Value

FPF270X has an adjustable 0.4 A to 2.0 A minimum current limit set through an external resistor,  $R_{SET}$ , connected between ISET and GND. A precision  $R_{SET}$  value must be used, such as 1% tolerance or lower, to minimize the total current limit tolerance of the system.

Use the following equation to calculate the value of the resistor for intended typical current limit value:

$$R_{SET} (\text{k}\Omega) = \frac{277.5}{I_{LIM(TYP)} (\text{A})} \quad (1)$$

$I_{LIM(TYP)}$  is the typical current limit value based on a  $R_{SET}$ .

**Table 1. R<sub>SET</sub> Selection Guide**

R <sub>SET</sub> (kΩ)	Current Limit [A]			Tol. (%)
	Min.	Typ.	Max.	
111	2.00	2.50	3.00	20
124	1.79	2.24	2.69	20
147	1.51	1.89	2.27	20
182	1.22	1.52	1.83	20
220	1.01	1.26	1.51	20
274	0.81	1.01	1.22	20
374	0.59	0.74	0.89	20
549	0.40	0.51	0.61	20

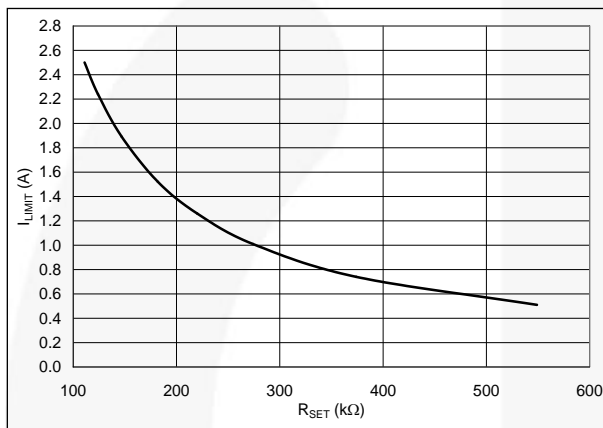

**Figure 36. I<sub>LIM</sub> vs. R<sub>SET</sub>**

**Under-Voltage Lockout (UVLO)**

The under-voltage lockout feature turns off the switch if the input voltage drops below the under-voltage lockout threshold. With the ON pin active (ON pin pulled LOW), the input voltage rising above the under-voltage lockout threshold causes a controlled turn-on of the switch (Figure 37). The UVLO threshold voltage is set internally at 2.5 V for V<sub>IN</sub> rising. The under-voltage lockout threshold has a 0.1 V hysteresis.

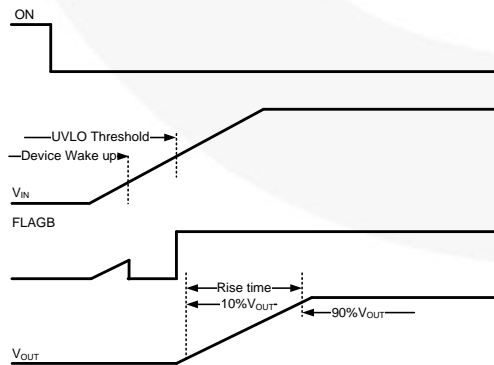

**Figure 37. Under-Voltage Lockout Performance**

**Power Good**

FPF270X has a power good feature. The PGOOD pin is an open-drain MOSFET that asserts HIGH when the output voltage reaches 90% of the input voltage (Figure 26). A typical 3% PGOOD hysteresis is added to PGOOD to prevent PGOOD from chattering as V<sub>OUT</sub> falls near the PGOOD threshold voltage.

The PGOOD pin requires an external pull-up resistor connected to an external voltage source compatible with input levels of other chips connected to this pin. PGOOD is kept LOW when the device is inactive. To save current in the OFF state, the pull-up resistor of the PGOOD pin can be connected to the output voltage when there is no battery, provided that compatibility with the input levels of other devices connected to PGOOD is observed. A typical value of 100 kΩ is recommended for the pull up resistor. When the power-good feature is not used in the application, the PGOOD pin can be connected to GND.

**Thermal Shutdown**

Thermal shutdown protects the die from internally or externally generated excessive temperatures. During an over-temperature condition; as the temperature increases above 140°C, FLAGB is activated and the switch is turned off.

When the die cools down sufficiently (die temperature drops below the threshold level), the switch automatically turns on again. To avoid unwanted thermal oscillations, a 30°C (typical) thermal hysteresis is implemented between thermal shutdown entry and exit temperatures. Proper board layout is required to prevent premature thermal shutdown (see Figure 38 for thermal shutdown behavior on FPF2702).

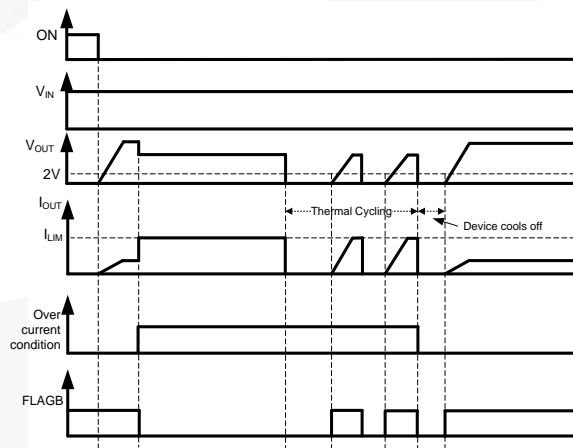

**Figure 38. FPF2702 Thermal Shutdown Behavior**

### SOA (FPF2702)

During extended output-short conditions, excessive power dissipation occurs in the load switch. FPF2700 and FPF2701 are protected by turning off the load switch after blanking time. FPF2702 has no blanking time feature; please refer to Note 3.

It is possible to estimate the SOA for the two FPF2702 packages, MPX and MX, through their respective SOA curves shown in Figure 39 and Figure 40. These curves provide a reference on how long the load switch survives under the worst-case scenario with minimum pad size of one square inch.<sup>(1)</sup>

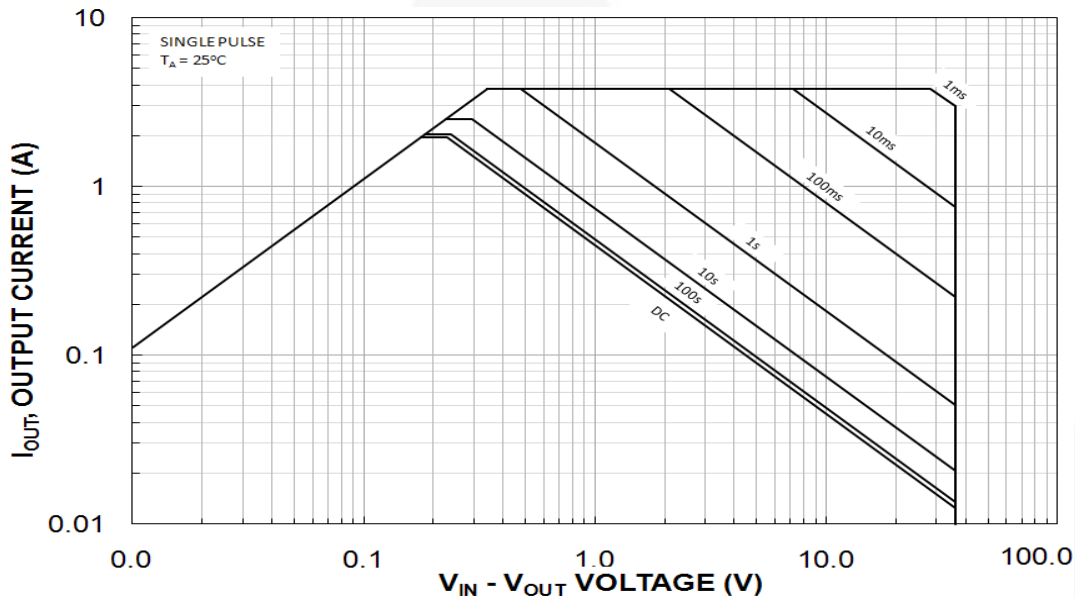

Figure 39. FPF2702 MPX SOA

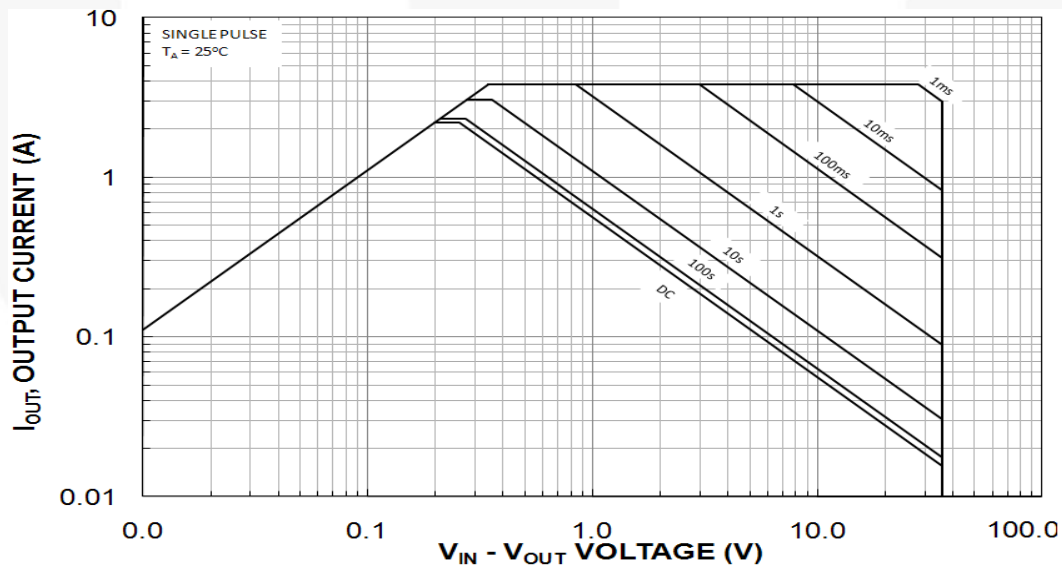

Figure 40. FPF2702 MX SOA

**Note:**

- To protect FPF2702 from an extended short condition, additional protection must be implemented in the system to protect the device. For example, the FLAGB and PGOOD signal can be used to monitor the short-circuit fault condition. In applications where FPF2702 can be exposed to persistent short-circuit conditions, it should be used only with external fault management control to protect the switch.

## Input Capacitor

To limit the voltage drop on the input supply caused by transient inrush currents when the switch is turned on into a discharged load capacitor or short-circuit; an input capacitor,  $C_{IN}$ , is recommended between the IN and GND pins. The FPF270X features a fast current limit response time (50  $\mu$ s). During this period, the device relies on the input capacitor to supply the load current. A 10  $\mu$ F to 100  $\mu$ F ceramic capacitor is adequate for  $C_{IN}$  in most cases. Larger  $C_{IN}$  values may be required in high-voltage or high-current applications. An electrolytic capacitor can be used in parallel to further reduce the voltage drop.

## Output Capacitor

A 0.1  $\mu$ F to 1  $\mu$ F capacitor,  $C_{OUT}$ , should be placed between the OUT and GND pins. This capacitor helps prevent parasitic board inductances from forcing the output voltage below ground when the switch turns off. This capacitor should have a low dissipation factor. An X7R Multilayer Ceramic Chip (MLCC) capacitor is recommended.

During startup, the total output current consists of both the load current and the charge current of the output capacitor. For the FPF2700 and FPF2701; if the total output current exceeds the set current limit threshold (determined via  $R_{SET}$ ) for longer than the blanking time, the device may not be able to start properly. This imposes an upper limit to the value of the output capacitor, given the load current and the selected current limit value.  $C_{OUT}$  should not exceed the  $C_{OUTmax}$  calculated in Equation 2 or the switch does not start properly due to the set current limit:

$$C_{OUT\ max} \leq I_{LIM\_MIN} \times 500\mu s / V \quad (2)$$

## High-Voltage Operation (Output Capacitor)

During a hard short condition on the output while operating at greater than 24 V  $V_{IN}$ , a large instantaneous inrush current is delivered to the shorted output. A capacitor must be placed at the OUTPUT pin, acting as a current source to support the instantaneous current draw (Table 2). A low-ESR capacitor is recommended. Once the value of the output capacitor is determined from Table 2, Equation 2 must be reevaluated.

**Table 2.  $C_{OUT}$  Selection Guide**

$V_{IN}$ (V)	Capacitance ( $\mu$ F)
24 < $V_{IN}$ $\leq$ 27	22
27 < $V_{IN}$ $\leq$ 32	47
32 < $V_{IN}$ $\leq$ 36	68

## Power Dissipation

During normal operation as a switch, the power dissipation of the device is small and has little effect on the operating temperature of the part. The maximum power dissipation for the switch in normal operation occurs just before the switch enters into current limit. This may be calculated using the equation:

$$P_{D\_MAX(NormalOperation)} = (I_{LIM(Max)})^2 \times R_{ON(MAX)} \quad (3)$$

The maximum junction temperature should be limited to 125°C under normal operation. Junction temperature can be calculated using the equation:

$$T_J = P_D \times \Theta_{JA} + T_A \quad (4)$$

where:

- $T_J$  is junction temperature;
- $P_D$  is power dissipation on the switch;
- $\Theta_{JA}$  is the thermal resistance, junction-to-ambient of the package; and
- $T_A$  is ambient temperature.

## Design Example

For a 12 V application and  $I_{LIM(Max)} = 1$  A, maximum power dissipation in a normal operation is calculated as:

$$P_{D\_MAX(NormalOperation)(VIN=12V)} = (1)^2 \times 0.140 = 140mW \quad (5)$$

FPF2702  $P_{D(Max)}$  during OC:

If device is in over-current condition and  $V_{OUT} > 2$  V, power dissipation can be calculated as:

$$P_D = (V_{IN} - V_{OUT}) \times I_{LIM(Max)} \quad (6)$$

If device is in short-circuit current limit and  $V_{OUT} < 2$  V, power dissipation can be calculated as:

$$P_D = (V_{IN} - V_{OUT}) \times (0.75 \times I_{LIM(Max)}) \quad (7)$$

## Design Example:

Using FPF2702 in a  $V_{IN} = 5$  V application where  $I_{LIM(Max)} = 2$  A, assuming  $V_{OUT} = 2.5$  V; power dissipation across the switch is calculated as:

$$P_D = (5 - 2.5) \times 2 = 5W \quad (8)$$

Whereas in a short-circuit current-limit condition ( $V_{OUT} \approx 0$  V), power dissipation is calculated as:

$$P_D = ((V_{IN} - V_{OUT}) \times (0.75 \times I_{LIM(Max)})) = (5 - 0) \times (0.75 \times 2) = 7.5W \quad (9)$$

## PCB Layout Recommendations

For the best performance, all traces should be as short as possible. To be most effective, the input and output capacitors should be placed close to the device to minimize the effects that parasitic trace inductances may have on normal and short-circuit operation (Figure 42). Using wide traces for IN, OUT, and GND pins helps minimize parasitic electrical effects as well as the case-to-ambient thermal impedance.

To minimize the interference between analog ground (chip ground, pin 5) and power ground during load current excursion, the ground terminal of the input and output capacitors and the R<sub>SET</sub> resistor should be routed directly to chip ground and away from power ground.

### Improving Thermal Performance

Improper layout could result in higher junction temperature and trigger thermal shutdown protection. This is particularly significant for the FPF2702, where the device operates in Constant Current Mode under overload conditions. During fault conditions, the power dissipation of the switch could exceed the maximum absolute power dissipation.

The following techniques improve the thermal performance of this family of devices. These techniques are listed in order of the significance of their impact.

1. Thermal performance of the load switch can be improved by connecting the Die Attach Pad (DAP) of the MLP 3x3 package to the GND plane of the PCB.
2. Embedding two exposed through-hole vias into the DAP provides a path for heat to transfer to the back GND plane of the PCB. A drill size of round, 15 mils (0.4 mm) with 1-ounce copper plating is recommended for appropriate solder reflow. A smaller-size hole prevents the solder from penetrating into the via, resulting in device lift-up. Similarly, a larger hole consumes excessive solder and may result in voiding the DAP.

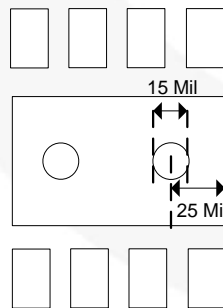

Figure 41. Two Through-Hole Open Vias Embedded in the DAP

3. The IN, OUT, and GND pins dissipate most of the heat generated during high-load current condition. The layout suggested in Figure 42 and Figure 43 is strongly recommended illustrating a proper layout for devices in MLP 3x3 packages. IN, OUT, and GND pins are connected to adequate copper so that heat may be transferred as efficiently as possible out of the device. The low-power FLAGB and ON pins traces may be laid-out diagonally from the device to maximize the area available to the ground pad. Place the input and output capacitors as close as possible to the device.

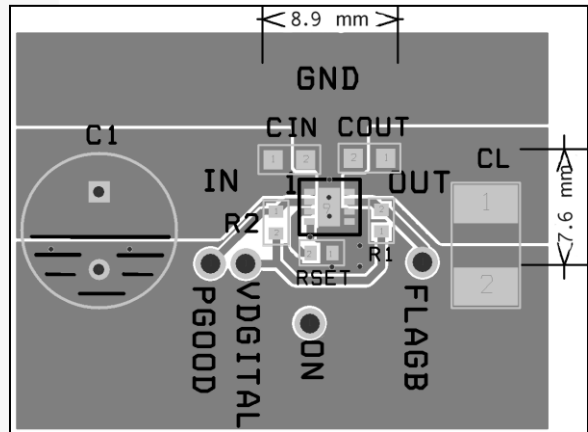

Figure 42. Proper Layout of Output and Ground Copper Area (Top, SST, and AST Layers)

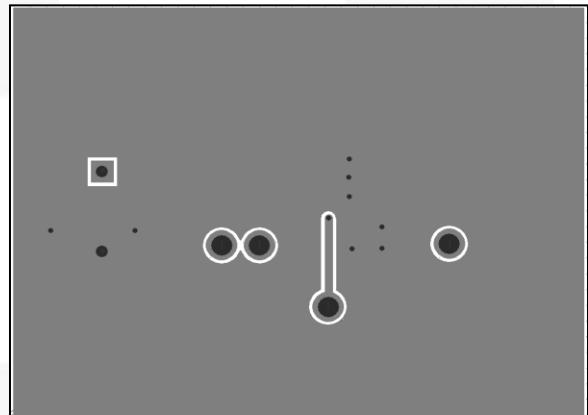

Figure 43. Proper Layout (Bottom and ASB Layers)



## FPF270x Demonstration Board

The FPF270X demonstration board has components and circuitry to demonstrate the load switch's functions and features. Thermal performance of the board is improved using the techniques recommended in the

layout recommendations section. Additional information about demonstration board can be found in the FPF270X board users guide.

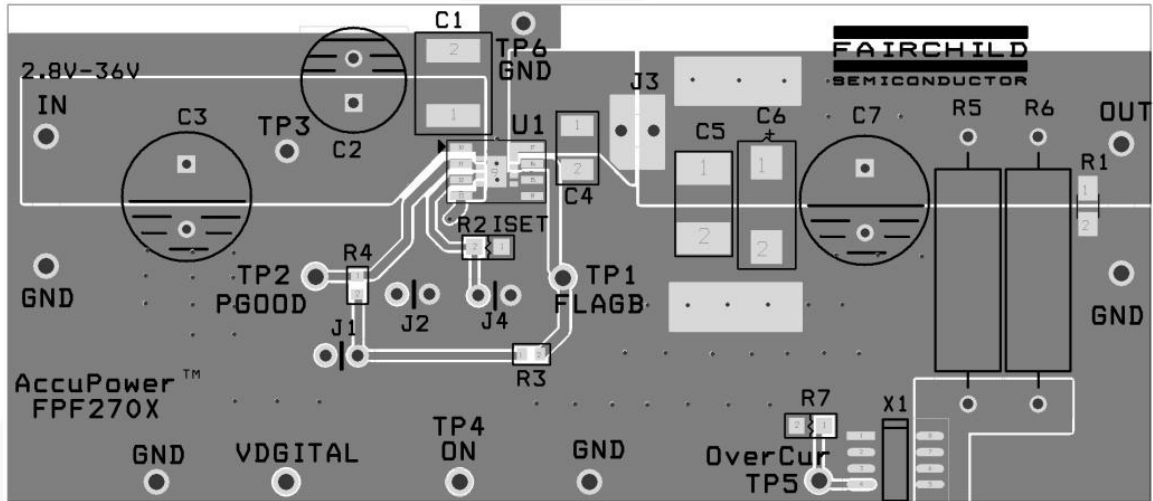

Figure 44. Top, SST, and AST Layers

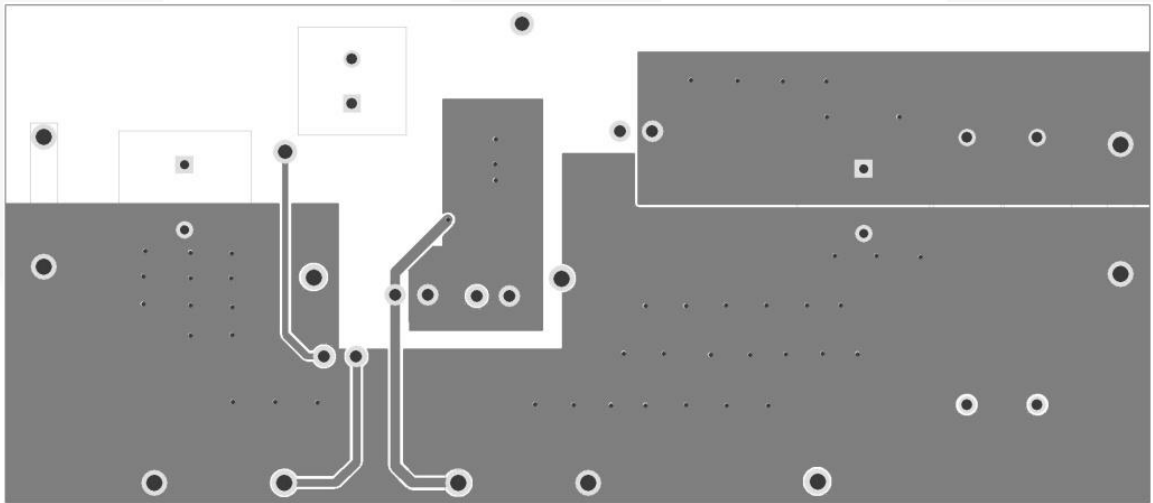

Figure 45. Bottom and ASB Layers

### Physical Dimensions

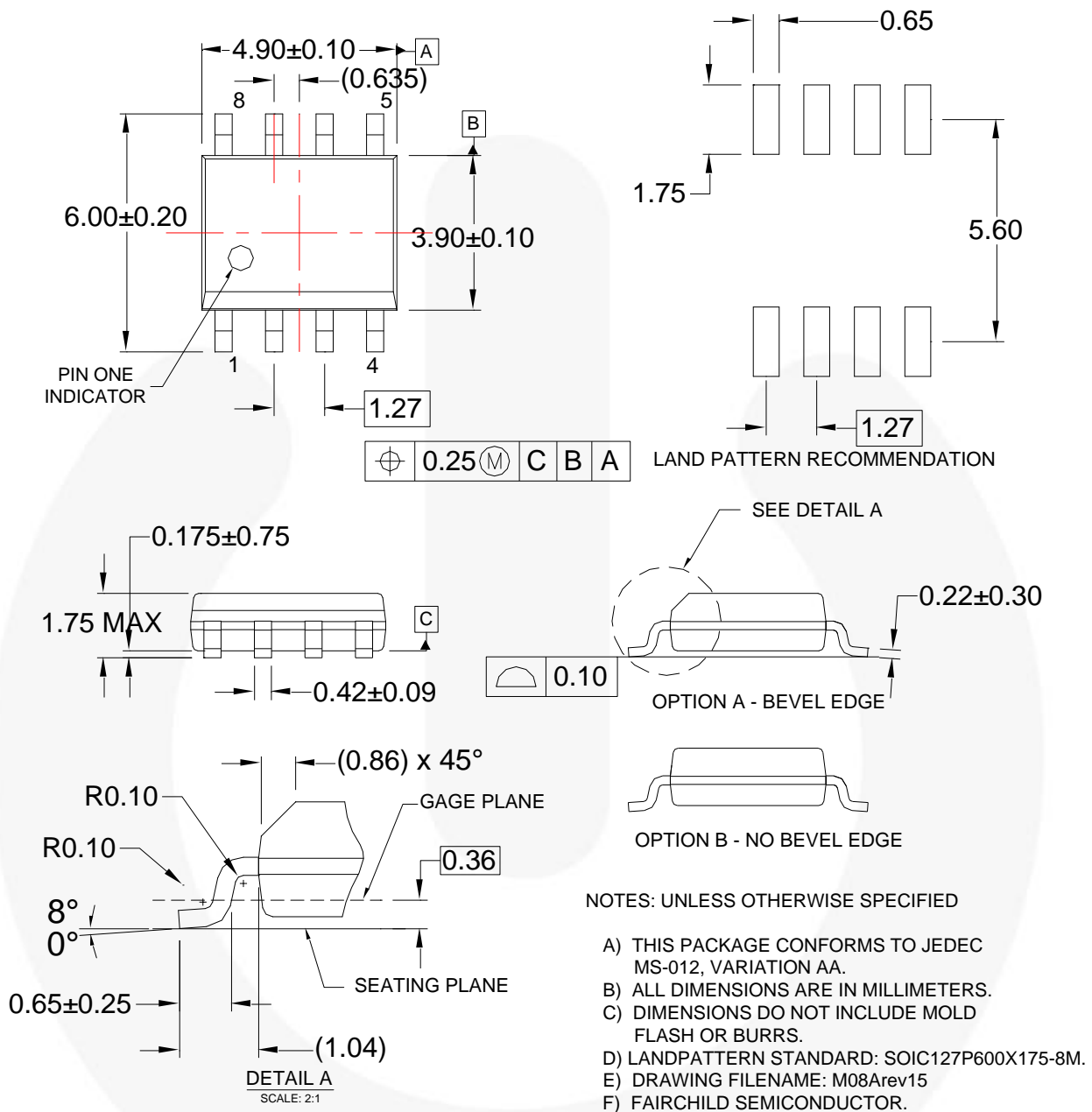
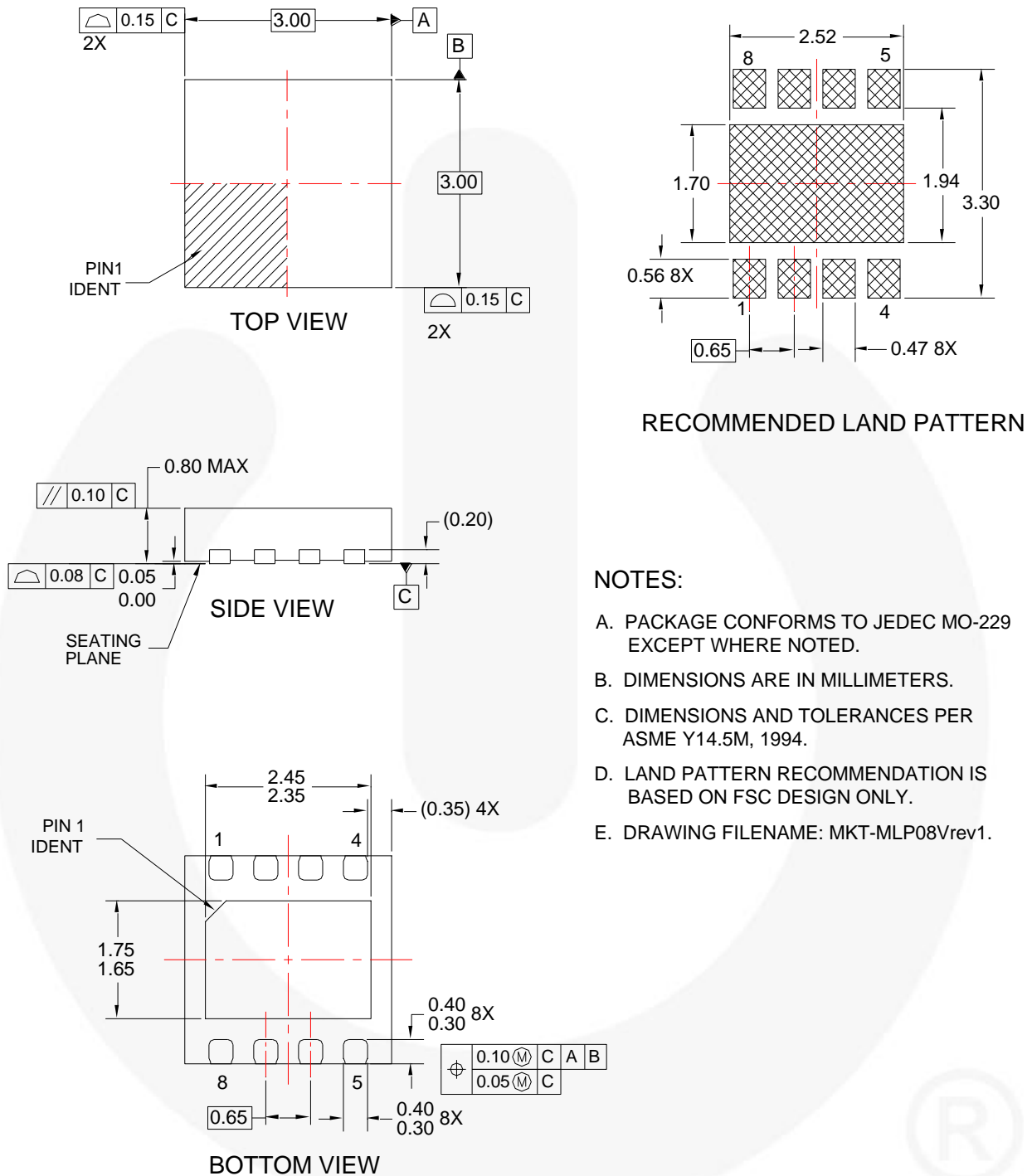

Figure 46. 8-Lead, Small Outline Package (SOP)

Package drawings are provided as a service to customers considering Fairchild components. Drawings may change in any manner without notice. Please note the revision and/or date on the drawing and contact a Fairchild Semiconductor representative to verify or obtain the most recent revision. Package specifications do not expand the terms of Fairchild's worldwide terms and conditions, specifically the warranty therein, which covers Fairchild products.

Always visit Fairchild Semiconductor's online packaging area for the most recent package drawings:  
<http://www.fairchildsemi.com/dwg/M0/M08A.pdf>.

### Physical Dimensions



#### NOTES:

- A. PACKAGE CONFORMS TO JEDEC MO-229 EXCEPT WHERE NOTED.
- B. DIMENSIONS ARE IN MILLIMETERS.
- C. DIMENSIONS AND TOLERANCES PER ASME Y14.5M, 1994.
- D. LAND PATTERN RECOMMENDATION IS BASED ON FSC DESIGN ONLY.
- E. DRAWING FILENAME: MKT-MLP08Vrev1.

**Figure 47. 8-Lead, 3x3 mm Molded Leadless Package (MLP)**

Package drawings are provided as a service to customers considering Fairchild components. Drawings may change in any manner without notice. Please note the revision and/or date on the drawing and contact a Fairchild Semiconductor representative to verify or obtain the most recent revision. Package specifications do not expand the terms of Fairchild's worldwide terms and conditions, specifically the warranty therein, which covers Fairchild products.

Always visit Fairchild Semiconductor's online packaging area for the most recent package drawings:  
<http://www.fairchildsemi.com/dwg/ML/MLP08V.pdf>.



**TRADEMARKS**

The following includes registered and unregistered trademarks and service marks, owned by Fairchild Semiconductor and/or its global subsidiaries, and is not intended to be an exhaustive list of all such trademarks.

- |                          |  |                                       |                  |
|--------------------------|--|---------------------------------------|------------------|
| AccuPower™               | F-PFS™   | PowerTrench®                          | Sync-Lock™       |
| AX-CAP®*                 | FRFET®   | PowerXS™                              | SYSTEM GENERAL®  |
| BitSiC™                  | Global Power Resource™                         | Programmable Active Droop™            | TinyBoost®       |
| Build it Now™            | GreenBridge™                                   | QFET®                                 | TinyBuck®        |
| CorePLUS™                | Green FPS™                                     | QS™                                   | TinyCalc™        |
| CorePOWER™               | Green FPS™ e-Series™                           | Quiet Series™                         | TinyLogic®       |
| CROSSVOLT™               | Gmax™  | RapidConfigure™                       | TINYOPTO™        |
| CTL™                     | GTO™   | Saving our world, 1mW/W/kW at a time™ | TinyPower™       |
| Current Transfer Logic™  | IntelliMAX™                                    | SignalWise™                           | TinyPWM™         |
| DEUXPEED®                | ISOPLANAR™                                     | SmartMax™                             | TinyWire™        |
| Dual Cool™               | Making Small Speakers Sound Louder and Better™ | SMART START™                          | TranSiC™         |
| EcoSPARK®                | MegaBuck™                                      | Solutions for Your Success™           | TriFault Detect™ |
| EfficientMax™            | MICROCOUPLER™                                  | SPM®                                  | TRUECURRENT®*    |
| ESBC™                    | MicroFET™                                      | STEALTH™                              | μSerDes™         |
| Fairchild®               | MicroPak™                                      | SuperFET®                             | SerDes®          |
| Fairchild Semiconductor® | MicroPak2™                                     | SuperSOT™-3                           | UHC®             |
| FACT Quiet Series™       | MillerDrive™                                   | SuperSOT™-6                           | Ultra FRFET™     |
| FACT®                    | MotionMax™                                     | SuperSOT™-8                           | UniFET™          |
| FAST®                    | mWSaver®                                       | SupreMOS®                             | VCX™             |
| FastvCore™               | OptoHiT™                                       | SyncFET™                              | VisualMax™       |
| FETBench™                | OPTOLOGIC®                                     |                                       | VoltagePlus™     |
| FPS™                     | OPTOPLANAR®                                    |                                       | XS™              |

\* Trademarks of System General Corporation, used under license by Fairchild Semiconductor.

**DISCLAIMER**

FAIRCHILD SEMICONDUCTOR RESERVES THE RIGHT TO MAKE CHANGES WITHOUT FURTHER NOTICE TO ANY PRODUCTS HEREIN TO IMPROVE RELIABILITY, FUNCTION, OR DESIGN. FAIRCHILD DOES NOT ASSUME ANY LIABILITY ARISING OUT OF THE APPLICATION OR USE OF ANY PRODUCT OR CIRCUIT DESCRIBED HEREIN; NEITHER DOES IT CONVEY ANY LICENSE UNDER ITS PATENT RIGHTS, NOR THE RIGHTS OF OTHERS. THESE SPECIFICATIONS DO NOT EXPAND THE TERMS OF FAIRCHILD'S WORLDWIDE TERMS AND CONDITIONS, SPECIFICALLY THE WARRANTY THEREIN, WHICH COVERS THESE PRODUCTS.

**LIFE SUPPORT POLICY**

FAIRCHILD'S PRODUCTS ARE NOT AUTHORIZED FOR USE AS CRITICAL COMPONENTS IN LIFE SUPPORT DEVICES OR SYSTEMS WITHOUT THE EXPRESS WRITTEN APPROVAL OF FAIRCHILD SEMICONDUCTOR CORPORATION.

As used herein:

1. Life support devices or systems are devices or systems which, (a) are intended for surgical implant into the body or (b) support or sustain life, and (c) whose failure to perform when properly used in accordance with instructions for use provided in the labeling, can be reasonably expected to result in a significant injury of the user.
2. A critical component in any component of a life support, device, or system whose failure to perform can be reasonably expected to cause the failure of the life support device or system, or to affect its safety or effectiveness.

**ANTI-COUNTERFEITING POLICY**

Fairchild Semiconductor Corporation's Anti-Counterfeiting Policy. Fairchild's Anti-Counterfeiting Policy is also stated on our external website, [www.fairchildsemi.com](http://www.fairchildsemi.com), under Sales Support.

Counterfeiting of semiconductor parts is a growing problem in the industry. All manufacturers of semiconductor products are experiencing counterfeiting of their parts. Customers who inadvertently purchase counterfeit parts experience many problems such as loss of brand reputation, substandard performance, failed applications, and increased cost of production and manufacturing delays. Fairchild is taking strong measures to protect ourselves and our customers from the proliferation of counterfeit parts. Fairchild strongly encourages customers to purchase Fairchild parts either directly from Fairchild or from Authorized Fairchild Distributors who are listed by country on our web page cited above. Products customers buy either from Fairchild directly or from Authorized Fairchild Distributors are genuine parts, have full traceability, meet Fairchild's quality standards for handling and storage and provide access to Fairchild's full range of up-to-date technical and product information. Fairchild and our Authorized Distributors will stand behind all warranties and will appropriately address any warranty issues that may arise. Fairchild will not provide any warranty coverage or other assistance for parts bought from Unauthorized Sources. Fairchild is committed to combat this global problem and encourage our customers to do their part in stopping this practice by buying direct or from authorized distributors.

**PRODUCT STATUS DEFINITIONS**

**Definition of Terms**

Datasheet Identification	Product Status	Definition
Advance Information	Formative / In Design	Datasheet contains the design specifications for product development. Specifications may change in any manner without notice.
Preliminary	First Production	Datasheet contains preliminary data; supplementary data will be published at a later date. Fairchild Semiconductor reserves the right to make changes at any time without notice to improve design.
No Identification Needed	Full Production	Datasheet contains final specifications. Fairchild Semiconductor reserves the right to make changes at any time without notice to improve the design.
Obsolete	Not In Production	Datasheet contains specifications on a product that is discontinued by Fairchild Semiconductor. The datasheet is for reference information only.

Rev. I66

ON Semiconductor and  are trademarks of Semiconductor Components Industries, LLC dba ON Semiconductor or its subsidiaries in the United States and/or other countries. ON Semiconductor owns the rights to a number of patents, trademarks, copyrights, trade secrets, and other intellectual property. A listing of ON Semiconductor's product/patent coverage may be accessed at [www.onsemi.com/site/pdf/Patent-Marking.pdf](http://www.onsemi.com/site/pdf/Patent-Marking.pdf). ON Semiconductor reserves the right to make changes without further notice to any products herein. ON Semiconductor makes no warranty, representation or guarantee regarding the suitability of its products for any particular purpose, nor does ON Semiconductor assume any liability arising out of the application or use of any product or circuit, and specifically disclaims any and all liability, including without limitation special, consequential or incidental damages. Buyer is responsible for its products and applications using ON Semiconductor products, including compliance with all laws, regulations and safety requirements or standards, regardless of any support or applications information provided by ON Semiconductor. "Typical" parameters which may be provided in ON Semiconductor data sheets and/or specifications can and do vary in different applications and actual performance may vary over time. All operating parameters, including "Typicals" must be validated for each customer application by customer's technical experts. ON Semiconductor does not convey any license under its patent rights nor the rights of others. ON Semiconductor products are not designed, intended, or authorized for use as a critical component in life support systems or any FDA Class 3 medical devices or medical devices with a same or similar classification in a foreign jurisdiction or any devices intended for implantation in the human body. Should Buyer purchase or use ON Semiconductor products for any such unintended or unauthorized application, Buyer shall indemnify and hold ON Semiconductor and its officers, employees, subsidiaries, affiliates, and distributors harmless against all claims, costs, damages, and expenses, and reasonable attorney fees arising out of, directly or indirectly, any claim of personal injury or death associated with such unintended or unauthorized use, even if such claim alleges that ON Semiconductor was negligent regarding the design or manufacture of the part. ON Semiconductor is an Equal Opportunity/Affirmative Action Employer. This literature is subject to all applicable copyright laws and is not for resale in any manner.

## PUBLICATION ORDERING INFORMATION

### LITERATURE FULFILLMENT:

Literature Distribution Center for ON Semiconductor  
19521 E. 32nd Pkwy, Aurora, Colorado 80011 USA  
**Phone:** 303-675-2175 or 800-344-3860 Toll Free USA/Canada  
**Fax:** 303-675-2176 or 800-344-3867 Toll Free USA/Canada  
**Email:** [orderlit@onsemi.com](mailto:orderlit@onsemi.com)

**N. American Technical Support:** 800-282-9855 Toll Free  
USA/Canada  
**Europe, Middle East and Africa Technical Support:**  
Phone: 421 33 790 2910  
**Japan Customer Focus Center**  
Phone: 81-3-5817-1050

**ON Semiconductor Website:** [www.onsemi.com](http://www.onsemi.com)  
**Order Literature:** <http://www.onsemi.com/orderlit>  
For additional information, please contact your local  
Sales Representative