



ON Semiconductor®

<http://onsemi.com>

# LA4450

Monolithic Linear IC

## 2-Channel, 26V, Power Amplifier for Bus and Track in Car Stereo

### Overview

The LA4450 is a single package 2-channel power Amplifier that supports an operating voltage of 26V. It is particularly well suited for use as the bus and track power IC in car stereo applications. Additionally, since the LA4450 can drive 4Ω loads, it can be used effectively in high-power high-end products. Furthermore, since it supports a high operating voltage and has low distortion, it is also optimal for use in TV and home audio products.

### Features

- Two channels in a single package
- $P_O = 12W \times 2$  ( $V_{CC} = 26.4V$ ,  $R_L = 8\Omega$ , THD = 10%)
- $P_O = 20W \times 2$  ( $V_{CC} = 26.4V$ ,  $R_L = 4\Omega$ , THD = 10%)
- Can drive 4Ω speakers
- Built-in standby switch
- Minimizes impulse noises

### Functions

- Standby switch (active on high (+5V) input)
- On-chip impulse noise protection circuit
- On-chip thermal protection circuit
- On-chip overvoltage and surge protection circuits

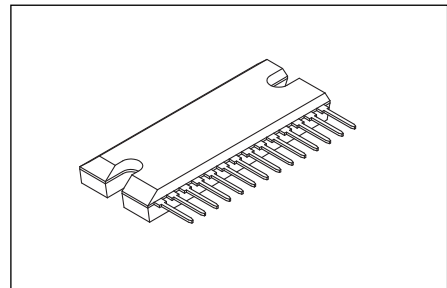

SIP14 36.8x13.8 / SIP14H

### Specifications

Maximum Ratings at  $T_a = 25^\circ C$ 

Parameter	Symbol	Conditions	Ratings	Unit
Maximum supply voltage	$V_{CC}$ max	$R_g = 0$ (no signal)	37	V
Maximum output current	$I_O$ peak		4	A
Allowable power dissipation	$P_d$ max	Infinite heat sink*	25	W
Operating temperature	$T_{opr}$		-35 to +80	$^\circ C$
Storage temperature	$T_{stg}$		-40 to +150	$^\circ C$

Note : \* Set  $V_{CC}$  and  $R_L$  within ranges that do not cause  $P_d$  max to exceed 25W.

Stresses exceeding those listed in the Maximum Ratings table may damage the device. If any of these limits are exceeded, device functionality should not be assumed, damage may occur and reliability may be affected.

Operating Conditions at  $T_a = 25^\circ C$ 

Parameter	Symbol	Conditions	Ratings	Unit
Recommended supply voltage	$V_{CC}$		26.4	V
Recommended load resistance	$R_L$		8	$\Omega$
Operating supply voltage range	$V_{CC}$ op		10 to 30	V

Functional operation above the stresses listed in the Recommended Operating Ranges is not implied. Extended exposure to stresses beyond the Recommended Operating Ranges limits may affect device reliability.

### ORDERING INFORMATION

See detailed ordering and shipping information on page 8 of this data sheet.

# LA4450

**Electrical Characteristics** at  $T_a = 25^\circ\text{C}$ ,  $V_{CC} = 26.4\text{V}$ ,  $R_L = 8\Omega$ ,  $f = 1\text{kHz}$ ,  $R_g = 600\Omega$

Parameter	Symbol	Conditions	Ratings			Unit
			min	typ	max	
Standby current	$I_{st}$	Standby switch off		1	30	$\mu\text{A}$
Quiescent current	$I_{CCO}$	$R_g = 0$	50	80	140	$\text{mA}$
Output power	$P_{O1}$	THD = 10%	10	12		$\text{W}$
	$P_{O2}$	THD = 10%, $R_L = 4\Omega$		20		$\text{W}$
Voltage gain	VG	$V_O = 0\text{dBm}$	49	51	53	$\text{dB}$
Total harmonic distortion	THD	$P_O = 1\text{W}$		0.07	0.4	%
Output noise voltage	$V_{NO}$	$R_g = 0$ , BPF-BW = 20Hz to 20kHz		0.4	1.0	$\text{mV}$
Ripple exclusion ratio	SVRR	$R_g = 0$ , $f_R = 100\text{Hz}$ , $V_R = 0\text{dBm}$	45	55		$\text{dB}$
Channel separation	CHsep	$V_O = 0\text{dBm}$ , $R_g = 10\text{k}\Omega$	45	55		$\text{dB}$
Standby control voltage	Vst	With a $10\text{k}\Omega$ resistor connected at pin 12	2.5		$V_{CC}$	$\text{V}$

Product parametric performance is indicated in the Electrical Characteristics for the listed test conditions, unless otherwise noted. Product performance may not be indicated by the Electrical Characteristics if operated under different conditions.

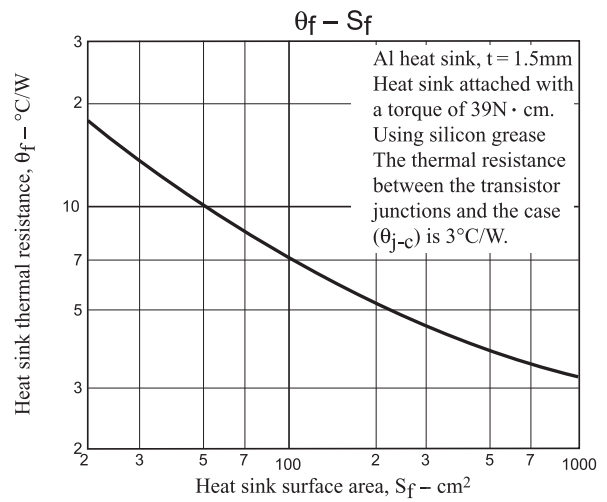
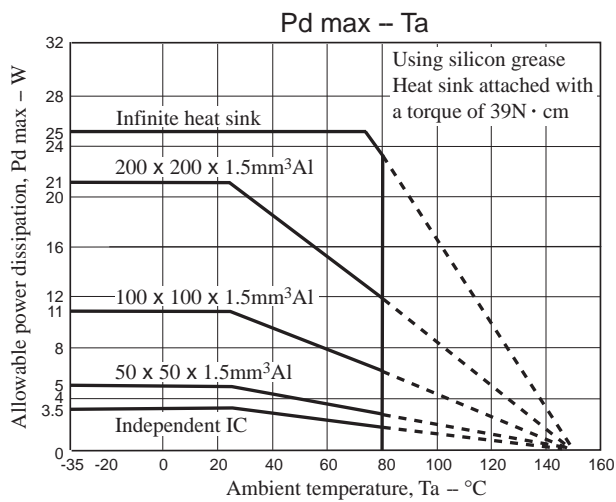

**Package Dimensions**

unit : mm

**SIP14 36.8x13.8 / SIP14H**  
**CASE 127AQ**  
**ISSUE A**

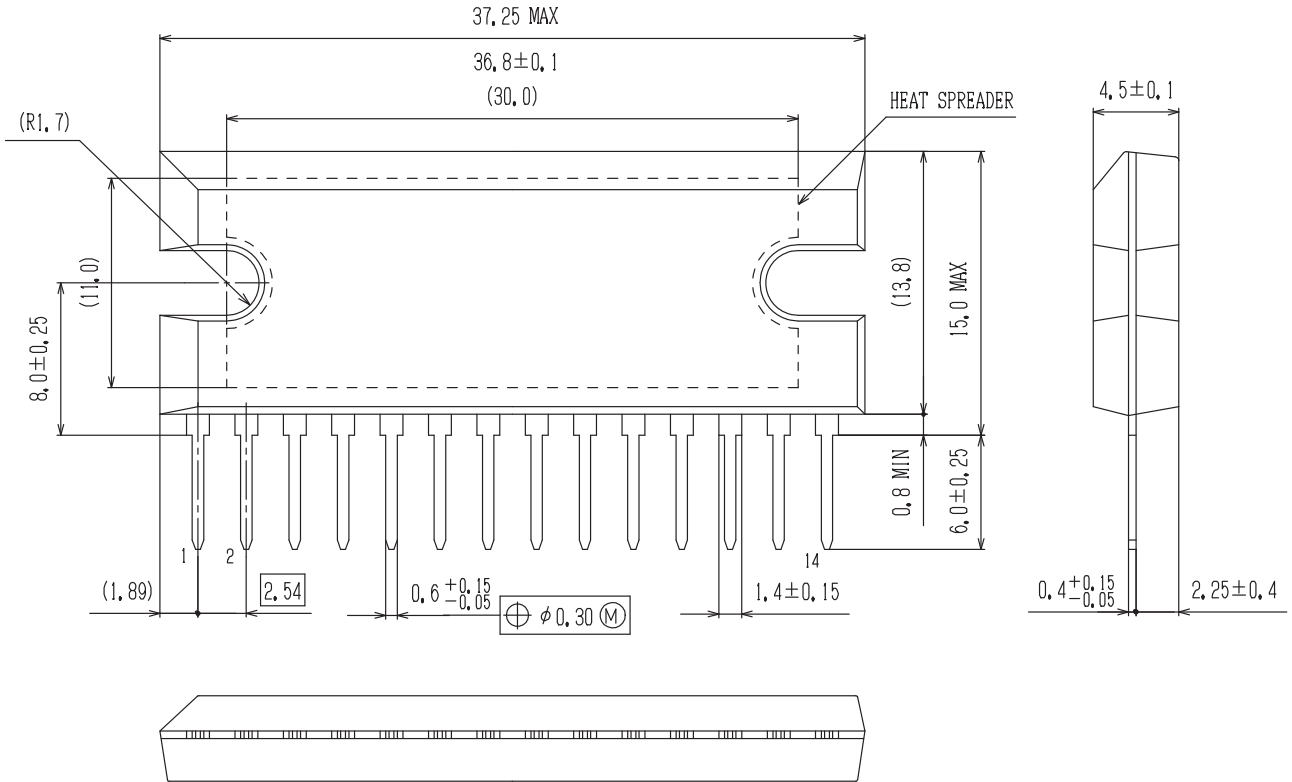

**GENERIC MARKING DIAGRAM\***

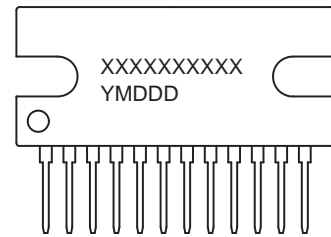

XXXXXX = Specific Device Code  
 Y = Year  
 M = Month  
 DDD = Additional Traceability Data

\*This information is generic. Please refer to device data sheet for actual part marking. Pb-Free indicator, "G" or microdot "▪", may or may not be present.

Test Circuit

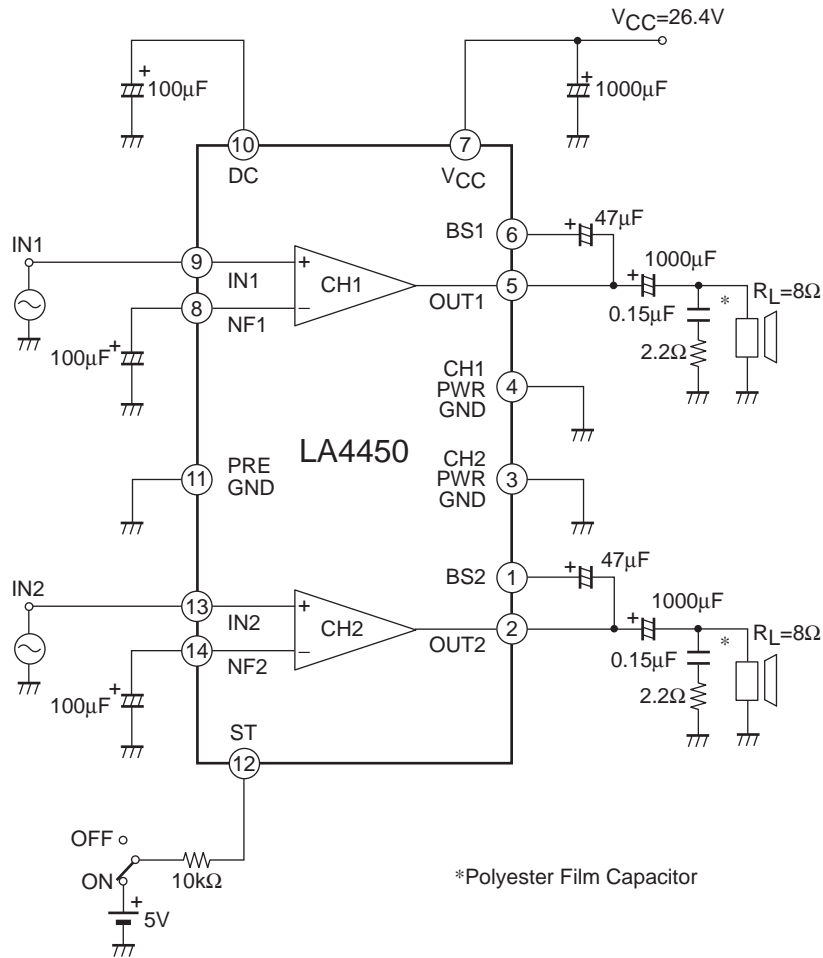

1. Features and Usage Notes

- Pin 12 is the standby pin. The IC operates when a voltage of 2V or higher is applied through the external resistor R1. Note that the maximum influx current to pin 12 is 500µA.
- Changing the voltage gain

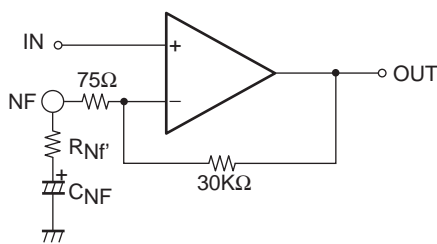

The voltage gain VG can be lowered by connecting an external resistor in series between the NF pin (pins 8 and 14) and CNF.

$$VG = 20 \log \frac{30k\Omega}{75 + R_{NF}}$$

However, since the IC may oscillate if VG is 30dB or lower, use a VG of 36dB or higher.

- The LA4450 includes a thermal protection circuit to prevent damage to or destruction of the IC due to abnormal overheating. As a result, the output may be attenuated or cut off if the application heat sinking is inadequate.
- The LA4450 includes an overvoltage protection circuit to protect the IC against power supply surges and abnormal voltages. This circuit has hysteresis characteristics : it operates at between 39 and 40V, and recovers at around 34V.
- Although the LA4450 includes a current limiter circuit to prevent damage due to abnormal currents, care must still be exercised to prevent load shorts and other excessive current conditions.

Application Circuit Example

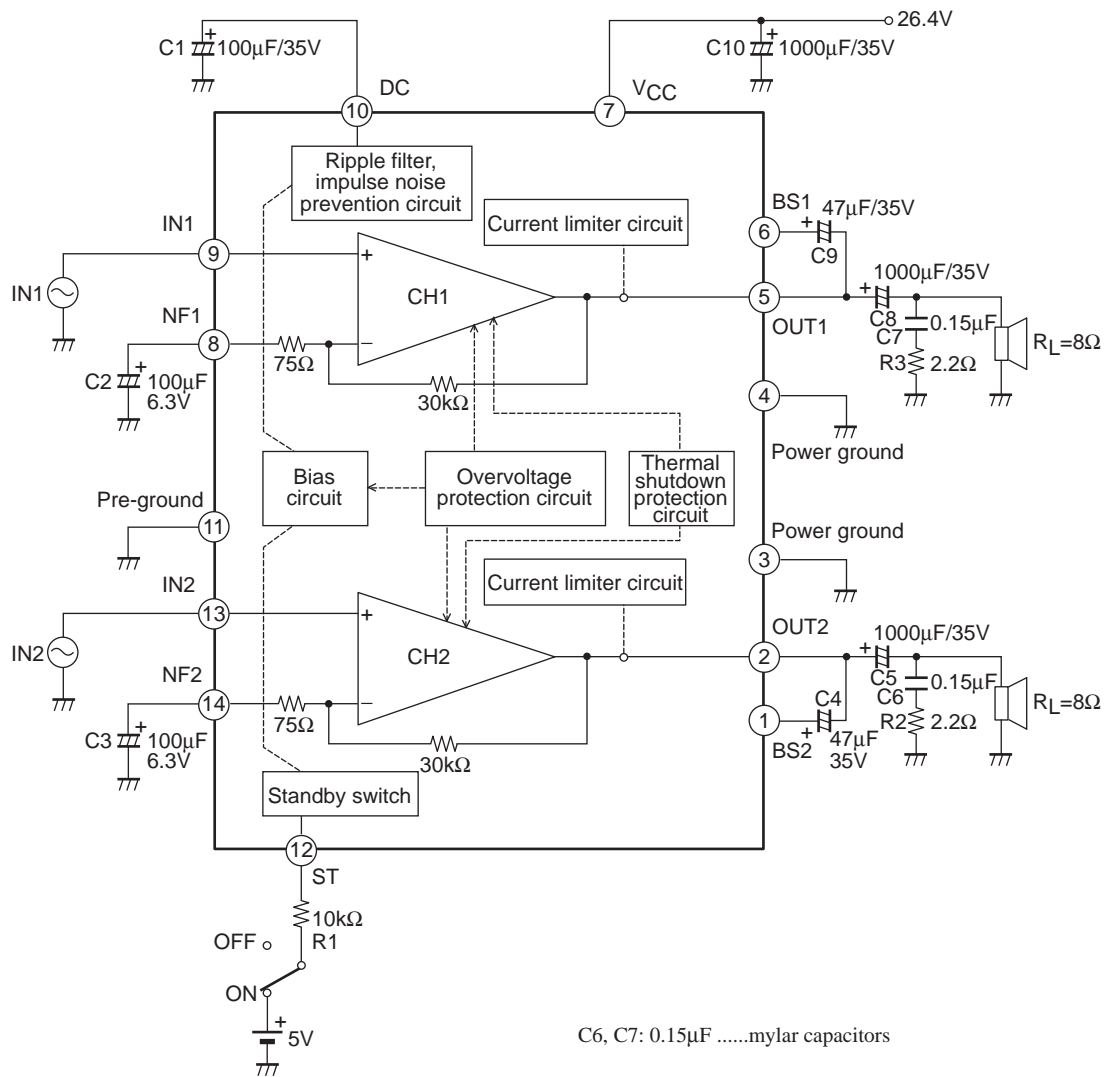

Printed Circuit Board Pattern Example

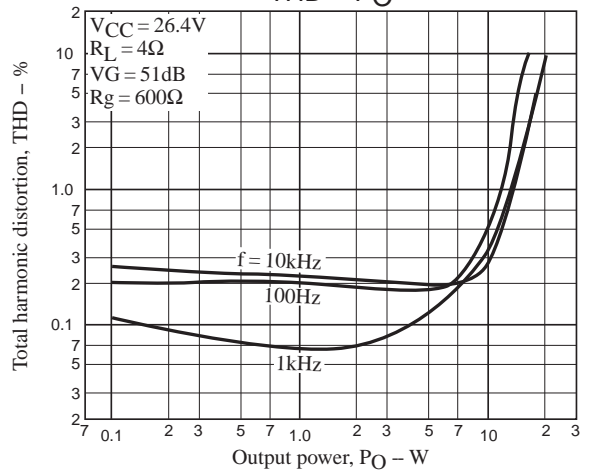
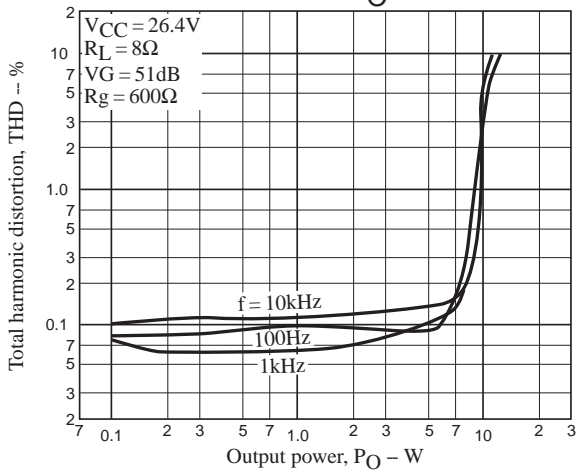
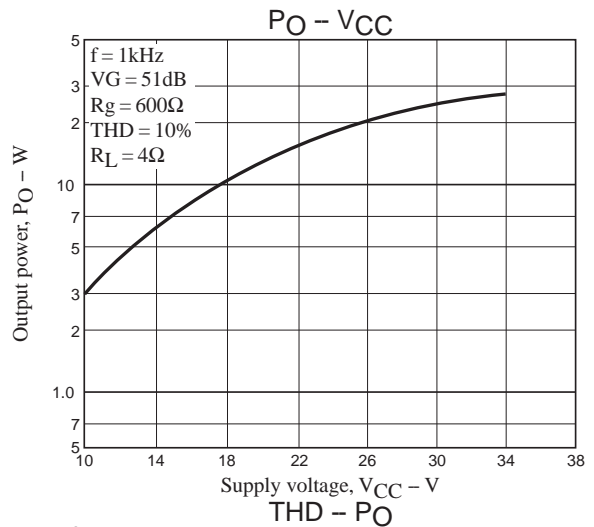
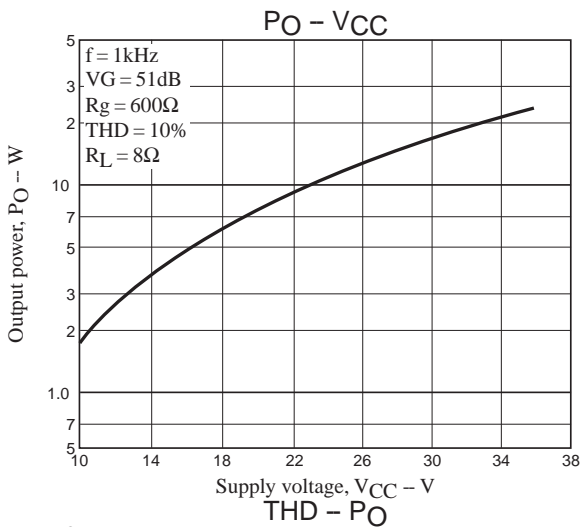
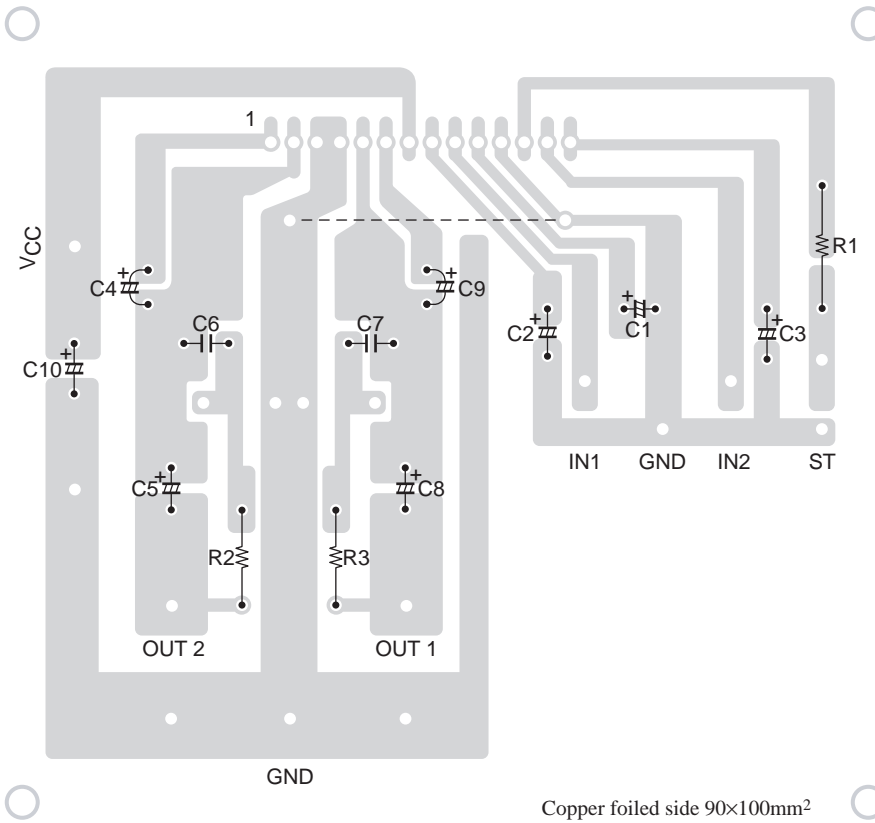

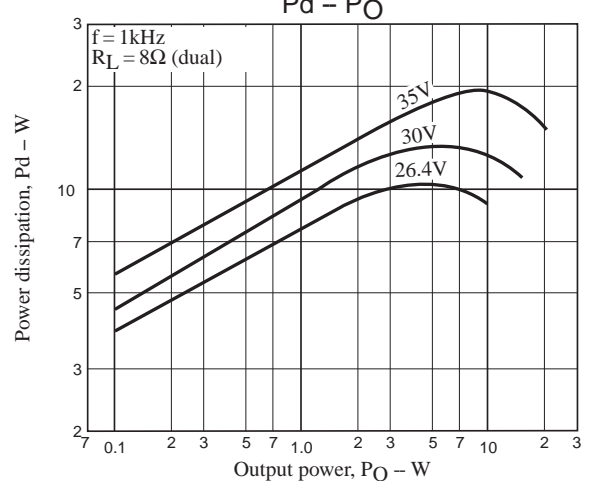
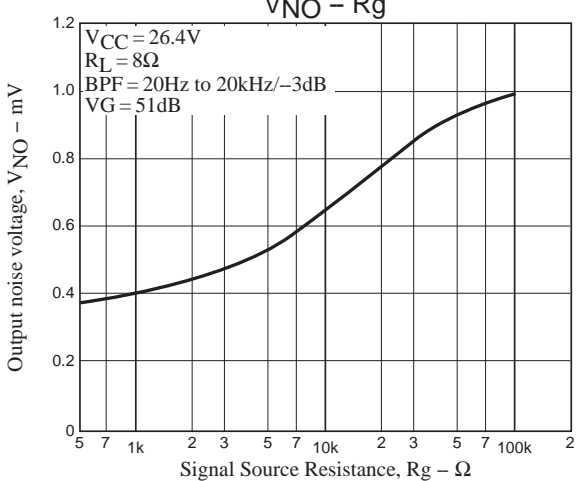
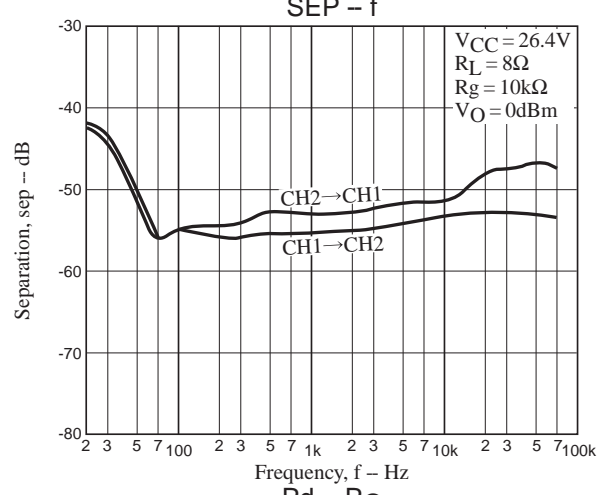
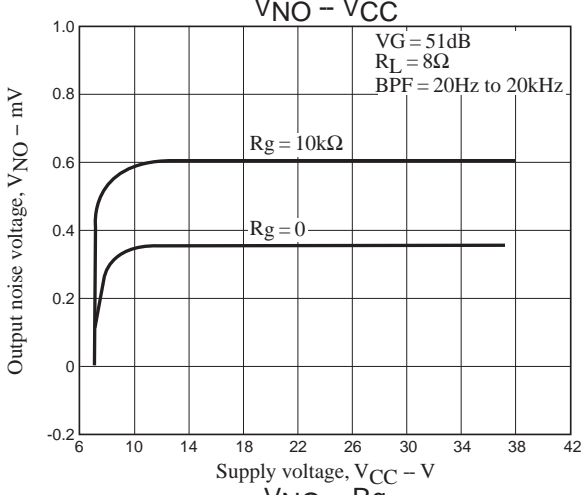
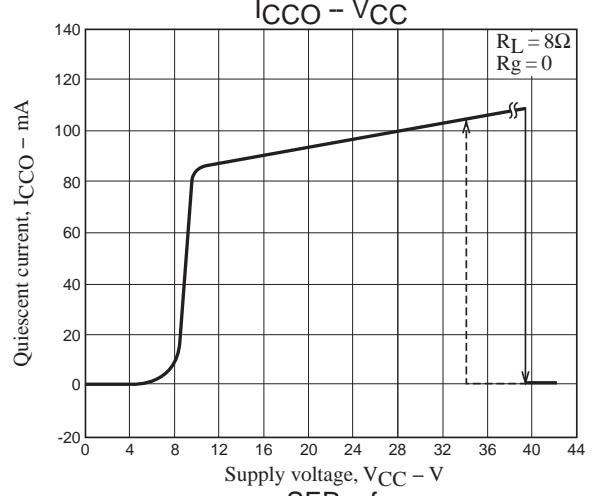
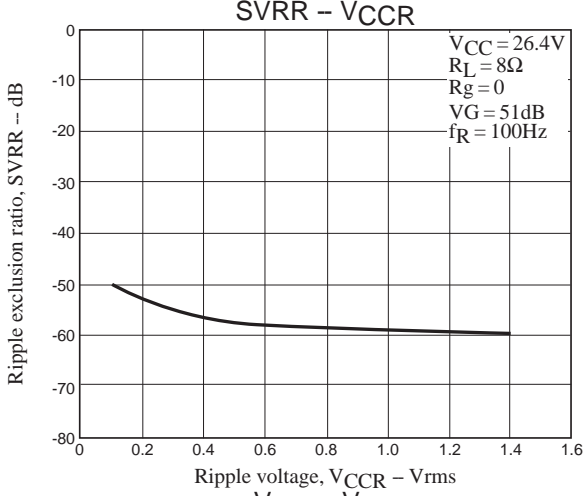
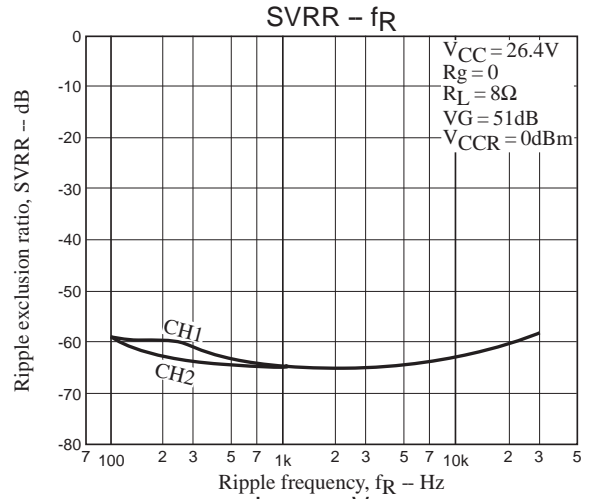
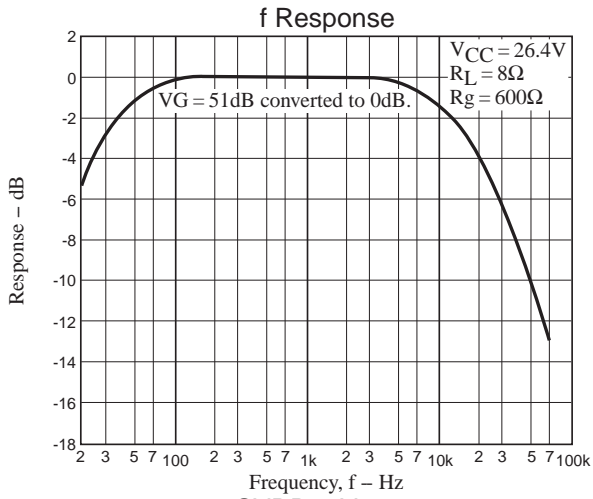

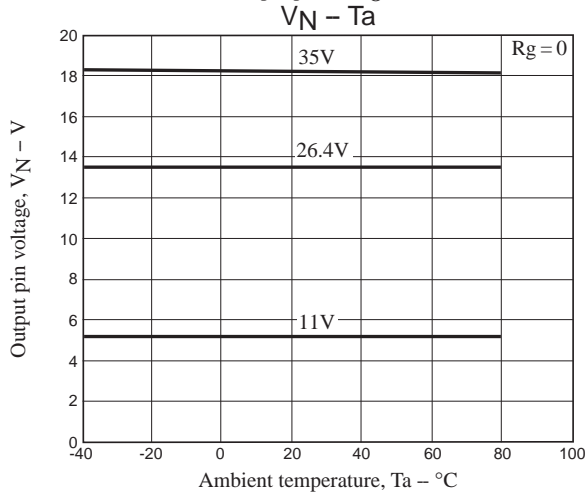
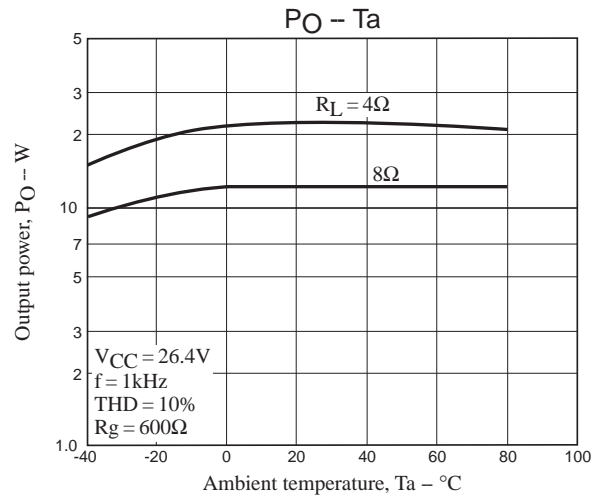
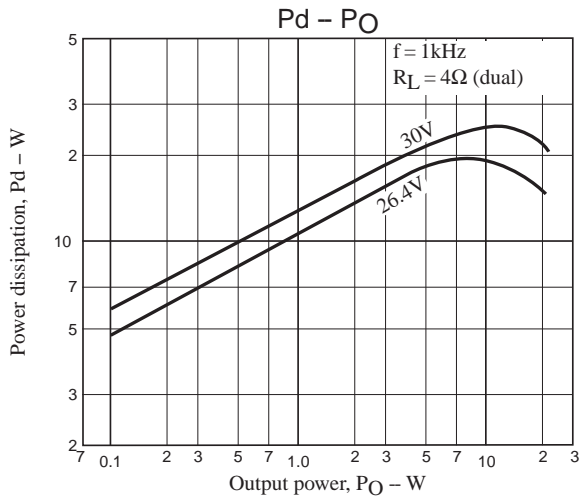

**ORDERING INFORMATION**

Device	Package	Shipping (Qty / Packing)
LA4450-E	SIP14 36.8x13.8 / SIP14H (Pb-Free)	15 / Fan-Fold
LA4450F-E	SIP14 36.8x13.8 / SIP14H (Pb-Free)	14 / Fan-Fold
LA4450L-E	SIP14 36.8x13.8 / SIP14H (Pb-Free)	15 / Fan-Fold

ON Semiconductor and the ON logo are registered trademarks of Semiconductor Components Industries, LLC (SCILLC). SCILLC owns the rights to a number of patents, trademarks, copyrights, trade secrets, and other intellectual property. A listing of SCILLC's product/patent coverage may be accessed at [www.onsemi.com/site/pdf/Patent-Marking.pdf](http://www.onsemi.com/site/pdf/Patent-Marking.pdf). SCILLC reserves the right to make changes without further notice to any products herein. SCILLC makes no warranty, representation or guarantee regarding the suitability of its products for any particular purpose, nor does SCILLC assume any liability arising out of the application or use of any product or circuit, and specifically disclaims any and all liability, including without limitation special, consequential or incidental damages. "Typical" parameters which may be provided in SCILLC data sheets and/or specifications can and do vary in different applications and actual performance may vary over time. All operating parameters, including "Typicals" must be validated for each customer application by customer's technical experts. SCILLC does not convey any license under its patent rights nor the rights of others. SCILLC products are not designed, intended, or authorized for use as components in systems intended for surgical implant into the body, or other applications intended to support or sustain life, or for any other application in which the failure of the SCILLC product could create a situation where personal injury or death may occur. Should Buyer purchase or use SCILLC products for any such unintended or unauthorized application, Buyer shall indemnify and hold SCILLC and its officers, employees, subsidiaries, affiliates, and distributors harmless against all claims, costs, damages, and expenses, and reasonable attorney fees arising out of, directly or indirectly, any claim of personal injury or death associated with such unintended or unauthorized use, even if such claim alleges that SCILLC was negligent regarding the design or manufacture of the part. SCILLC is an Equal Opportunity/Affirmative Action Employer. This literature is subject to all applicable copyright laws and is not for resale in any manner.