

# CD74HC4024, CD74HCT4024

## High Speed CMOS Logic 7-Stage Binary Ripple Counter

November 1997

### Features

- Fully Static Operation
- Buffered Inputs
- Common Reset
- Negative Edge Clocking
- Typical  $f_{MAX} = 60$  MHz at  $V_{CC} = 5V$ ,  $C_L = 15pF$ ,  $T_A = 25^\circ C$
- Fanout (Over Temperature Range)
  - Standard Outputs . . . . . 10 LSTTL Loads
  - Bus Driver Outputs . . . . . 15 LSTTL Loads
- Wide Operating Temperature Range . . .  $-55^\circ C$  to  $125^\circ C$
- Balanced Propagation Delay and Transition Times
- Significant Power Reduction Compared to LSTTL Logic ICs
- HC Types
  - 2V to 6V Operation
  - High Noise Immunity:  $N_{IL} = 30\%$ ,  $N_{IH} = 30\%$  of  $V_{CC}$  at  $V_{CC} = 5V$
- HCT Types
  - 4.5V to 5.5V Operation
  - Direct LSTTL Input Logic Compatibility,  $V_{IL} = 0.8V$  (Max),  $V_{IH} = 2V$  (Min)
  - CMOS Input Compatibility,  $I_I \leq 1\mu A$  at  $V_{OL}$ ,  $V_{OH}$

### Description

The Harris CD74HC4024 and CD74HCT4024 are 7-stage ripple-carry binary counters. All counter stages are master-slave flip-flops. The state of the stage advances one count on the negative transition of each input pulse; a high voltage level on the MR line resets all counters to their zero state. All inputs and outputs are buffered.

### Ordering Information

PART NUMBER	TEMP. RANGE ( $^\circ C$ )	PACKAGE	PKG. NO.
CD74HC4024E	-55 to 125	14 Ld PDIP	E14.3
CD74HCT4024M	-55 to 125	14 Ld SOIC	M14.15
CD74HC4024M	-55 to 125	14 Ld SOIC	M14.15

#### NOTES:

1. When ordering, use the entire part number. Add the suffix 96 to obtain the variant in the tape and reel.
2. Wafer or die for this part number is available which meets all electrical specifications. Please contact your local sales office or Harris customer service for ordering information.

### Pinout

CD74HC4024, CD74HCT4024  
(PDIP, SOIC)  
TOP VIEW

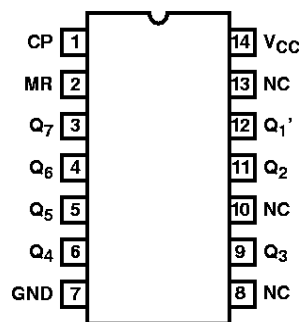

# CD74HC4024, CD74HCT4024

## Functional Diagram

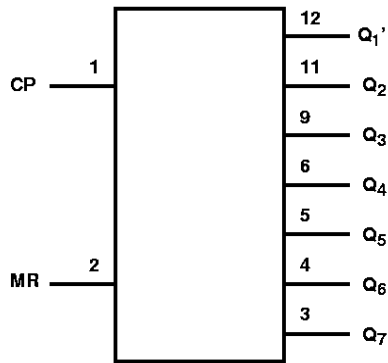

TRUTH TABLE

CP COUNT	MR	OUTPUT STATE
↑	L	No Change
↓	L	Advance to Next State
X	H	All Outputs Are Low

NOTE: H = High Voltage Level, L = Low Voltage Level, X = Don't Care,  
 ↑ = Transition from Low to High Level, ↓ = Transition from High to Low.

## Logic Diagram

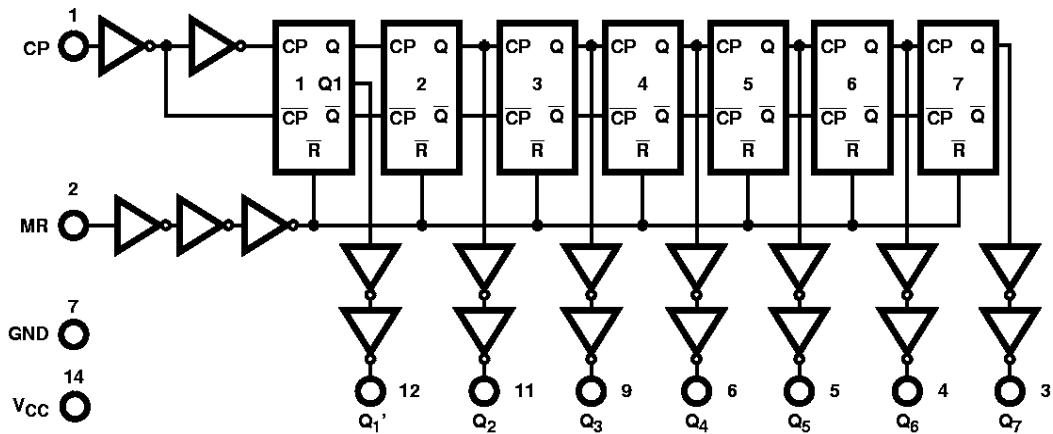

## CD74HC4024, CD74HCT4024

### Absolute Maximum Ratings

DC Supply Voltage, $V_{CC}$ .....	-0.5V to 7V
DC Input Diode Current, $I_{IK}$	
For $V_I < -0.5V$ or $V_I > V_{CC} + 0.5V$ .....	$\pm 20mA$
DC Output Diode Current, $I_{OK}$	
For $V_O < -0.5V$ or $V_O > V_{CC} + 0.5V$ .....	$\pm 20mA$
DC Output Source or Sink Current per Output Pin, $I_O$	
For $V_O > -0.5V$ or $V_O < V_{CC} + 0.5V$ .....	$\pm 25mA$
DC $V_{CC}$ or Ground Current, $I_{CC}$ .....	$\pm 50mA$

### Thermal Information

Thermal Resistance (Typical, Note 3)	$\theta_{JA}$ ( $^{\circ}C/W$ )
PDIP Package .....	90
SOIC Package .....	175
Maximum Junction Temperature .....	$150^{\circ}C$
Maximum Storage Temperature Range .....	$-65^{\circ}C$ to $150^{\circ}C$
Maximum Lead Temperature (Soldering 10s) .....	$300^{\circ}C$ (SOIC - Lead Tips Only)

### Operating Conditions

Temperature Range ( $T_A$ ) .....	$-55^{\circ}C$ to $125^{\circ}C$
Supply Voltage Range, $V_{CC}$	
HC Types .....	2V to 6V
HCT Types .....	4.5V to 5.5V
DC Input or Output Voltage, $V_I, V_O$ .....	0V to $V_{CC}$
Input Rise and Fall Time	
2V .....	1000ns (Max)
4.5V .....	500ns (Max)
6V .....	400ns (Max)

*CAUTION: Stresses above those listed in "Absolute Maximum Ratings" may cause permanent damage to the device. This is a stress only rating and operation of the device at these or any other conditions above those indicated in the operational sections of this specification is not implied.*

#### NOTE:

- $\theta_{JA}$  is measured with the component mounted on an evaluation PC board in free air.

### DC Electrical Specifications

PARAMETER	SYMBOL	TEST CONDITIONS		$V_{CC}$ (V)	25 $^{\circ}C$			-40 $^{\circ}C$ TO 85 $^{\circ}C$		-55 $^{\circ}C$ TO 125 $^{\circ}C$		UNITS
		$V_I$ (V)	$I_O$ (mA)		MIN	TYP	MAX	MIN	MAX	MIN	MAX	
<b>HC TYPES</b>												
High Level Input Voltage	$V_{IH}$	-	-	2	1.5	-	-	1.5	-	1.5	-	V
				4.5	3.15	-	-	3.15	-	3.15	-	V
				6	4.2	-	-	4.2	-	4.2	-	V
Low Level Input Voltage	$V_{IL}$	-	-	2	-	-	0.5	-	0.5	-	0.5	V
				4.5	-	-	1.35	-	1.35	-	1.35	V
				6	-	-	1.8	-	1.8	-	1.8	V
High Level Output Voltage CMOS Loads	$V_{OH}$	$V_{IH}$ or $V_{IL}$	-0.02	2	1.9	-	-	1.9	-	1.9	-	V
			-0.02	4.5	4.4	-	-	4.4	-	4.4	-	V
			-0.02	6	5.9	-	-	5.9	-	5.9	-	V
High Level Output Voltage TTL Loads	$V_{OH}$	$V_{IH}$ or $V_{IL}$	-	-	-	-	-	-	-	-	-	V
			-4	4.5	3.98	-	-	3.84	-	3.7	-	V
			-5.2	6	5.48	-	-	5.34	-	5.2	-	V
Low Level Output Voltage CMOS Loads	$V_{OL}$	$V_{IH}$ or $V_{IL}$	0.02	2	-	-	0.1	-	0.1	-	0.1	V
			0.02	4.5	-	-	0.1	-	0.1	-	0.1	V
			0.02	6	-	-	0.1	-	0.1	-	0.1	V
Low Level Output Voltage TTL Loads	$V_{OL}$	$V_{IH}$ or $V_{IL}$	-	-	-	-	-	-	-	-	-	V
			4	4.5	-	-	0.26	-	0.33	-	0.4	V
			5.2	6	-	-	0.26	-	0.33	-	0.4	V
Input Leakage Current	$I_I$	$V_{CC}$ or GND	-	6	-	-	$\pm 0.1$	-	$\pm 1$	-	$\pm 1$	$\mu A$
Quiescent Device Current	$I_{CC}$	$V_{CC}$ or GND	0	6	-	-	8	-	80	-	160	$\mu A$

## CD74HC4024, CD74HCT4024

### DC Electrical Specifications (Continued)

PARAMETER	SYMBOL	TEST CONDITIONS		V <sub>CC</sub> (V)	25°C			-40°C TO 85°C		-55°C TO 125°C		UNITS
		V <sub>I</sub> (V)	I <sub>O</sub> (mA)		MIN	TYP	MAX	MIN	MAX	MIN	MAX	
<b>HCT TYPES</b>												
High Level Input Voltage	V <sub>IH</sub>	-	-	4.5 to 5.5	2	-	-	2	-	2	-	V
Low Level Input Voltage	V <sub>IL</sub>	-	-	4.5 to 5.5	-	-	0.8	-	0.8	-	0.8	V
High Level Output Voltage CMOS Loads	V <sub>OH</sub>	V <sub>IH</sub> or V <sub>IL</sub>	-0.02	4.5	4.4	-	-	4.4	-	4.4	-	V
High Level Output Voltage TTL Loads			-4	4.5	3.98	-	-	3.84	-	3.7	-	V
Low Level Output Voltage CMOS Loads	V <sub>OL</sub>	V <sub>IH</sub> or V <sub>IL</sub>	0.02	4.5	-	-	0.1	-	0.1	-	0.1	V
Low Level Output Voltage TTL Loads			4	4.5	-	-	0.26	-	0.33	-	0.4	V
Input Leakage Current	I <sub>I</sub>	V <sub>CC</sub> and GND	0	5.5	-	-	±0.1	-	±1	-	±1	μA
Quiescent Device Current	I <sub>CC</sub>	V <sub>CC</sub> or GND	0	5.5	-	-	8	-	80	-	160	μA
Additional Quiescent Device Current Per Input Pin: 1 Unit Load	ΔI <sub>CC</sub>	V <sub>CC</sub> -2.1	-	4.5 to 5.5	-	100	360	-	450	-	490	μA

NOTE: For dual-supply systems theoretical worst case (V<sub>I</sub> = 2.4V, V<sub>CC</sub> = 5.5V) specification is 1.8mA.

### HCT Input Loading Table

INPUT	UNIT LOADS
CP, MR	0.5

NOTE: Unit Load is ΔI<sub>CC</sub> limit specified in DC Electrical Table, e.g., 360μA max at 25°C.

### Prerequisite for Switching Specifications

PARAMETER	SYMBOL	V <sub>CC</sub> (V)	25°C		-40°C TO 85°C		-55°C TO 125°C		UNITS
			MIN	MAX	MIN	MAX	MIN	MAX	
<b>HC TYPES</b>									
Maximum Input Pulse Frequency	f <sub>MAX</sub>	2	6	-	5	-	4	-	MHz
		4.5	30	-	24	-	20	-	MHz
		6	35	-	29	-	24	-	MHz
Input Pulse Width	t <sub>w</sub>	2	80	-	100	-	120	-	ns
		4.5	16	-	20	-	24	-	ns
		6	14	-	17	-	20	-	ns
Reset Removal Time	t <sub>REM</sub>	2	50	-	65	-	75	-	ns
		4.5	10	-	13	-	15	-	ns
		6	9	-	11	-	13	-	ns

## CD74HC4024, CD74HCT4024

### Prerequisite for Switching Specifications (Continued)

PARAMETER	SYMBOL	V <sub>CC</sub> (V)	25°C		-40°C TO 85°C		-55°C TO 125°C		UNITS
			MIN	MAX	MIN	MAX	MIN	MAX	
Reset Pulse Width	t <sub>W</sub>	2	80	-	100	-	120	-	ns
		4.5	16	-	20	-	24	-	ns
		6	14	-	17	-	20	-	ns
<b>HCT TYPES</b>									
Maximum Input Pulse Frequency	f <sub>MAX</sub>	4.5	25	-	20	-	16	-	MHz
Input Pulse Width	t <sub>W</sub>	4.5	20	-	25	-	30	-	ns
Reset Recovery Time	t <sub>REC</sub>	4.5	10	-	13	-	15	-	ns
Reset Pulse Width	t <sub>W</sub>	4.5	20	-	25	-	30	-	ns

### Switching Specifications Input t<sub>r</sub>, t<sub>f</sub> = 6ns

PARAMETER	SYMBOL	TEST CONDITIONS	V <sub>CC</sub> (V)	25°C			-40°C TO 85°C		-55°C TO 125°C		UNITS
				MIN	TYP	MAX	MIN	MAX	MIN	MAX	
<b>HC TYPES</b>											
Propagation Delay Time (Figure 1) CP to Q1' Output	t <sub>PLH</sub> , t <sub>PHL</sub>	C <sub>L</sub> = 50pF	2	-	-	140	-	175	-	210	ns
			4.5	-	-	28	-	35	-	42	ns
		C <sub>L</sub> = 15pF	5	-	11	-	-	-	-	-	ns
		C <sub>L</sub> = 50pF	6	-	-	24	-	30	-	36	ns
Q <sub>n</sub> to Q <sub>n</sub> + 1	t <sub>PLH</sub> , t <sub>PHL</sub>	C <sub>L</sub> = 50pF	2	-	-	75	-	95	-	110	ns
			4.5	-	-	15	-	19	-	22	ns
		C <sub>L</sub> = 15pF	5	-	6	-	-	-	-	-	ns
		C <sub>L</sub> = 50pF	6	-	-	13	-	13	-	19	ns
MR to Q <sub>n</sub>	t <sub>PLH</sub> , t <sub>PHL</sub>	C <sub>L</sub> = 50pF	2	-	-	170	-	215	-	255	ns
			4.5	-	-	34	-	43	-	51	ns
		5	-	14	-	-	-	-	-	ns	
		6	-	-	29	-	27	-	43	ns	
Output Transition Time (Figure 1)	t <sub>TLH</sub> , t <sub>THL</sub>	C <sub>L</sub> = 50pF	2	-	-	75	-	95	-	110	ns
			4.5	-	-	15	-	19	-	22	ns
			6	-	-	13	-	16	-	19	ns
Input Capacitance	C <sub>IN</sub>	C <sub>L</sub> = 50pF	-	-	-	10	-	10	-	10	pF
Power Dissipation Capacitance (Notes 4, 5)	C <sub>PD</sub>	C <sub>L</sub> = 15pF	5	-	30	-	-	-	-	-	pF
<b>HCT TYPES</b>											
Propagation Delay Time (Figure 2) CP to Q1' Output	t <sub>PLH</sub> , t <sub>PHL</sub>	C <sub>L</sub> = 50pF	4.5	-	-	40	-	50	-	60	ns
		C <sub>L</sub> = 15pF	5	-	17	-	-	-	-	-	ns
Q <sub>n</sub> to Q <sub>n</sub> + 1	t <sub>PLH</sub> , t <sub>PHL</sub>	C <sub>L</sub> = 50pF	4.5	-	-	15	-	19	-	22	ns
		C <sub>L</sub> = 15pF	5	-	6	-	-	-	-	-	ns
MR to Q <sub>n</sub>	t <sub>PLH</sub> , t <sub>PHL</sub>	C <sub>L</sub> = 50pF	4.5	-	-	40	-	50	-	60	ns
		C <sub>L</sub> = 15pF	5	-	17	-	-	-	-	-	ns

# CD74HC4024, CD74HCT4024

## Switching Specifications Input $t_r, t_f = 6\text{ns}$ (Continued)

PARAMETER	SYMBOL	TEST CONDITIONS	$V_{CC}$ (V)	25°C			-40°C TO 85°C		-55°C TO 125°C		UNITS
				MIN	TYP	MAX	MIN	MAX	MIN	MAX	
Output Transition	$t_{TLH}, t_{THL}$	$C_L = 50\text{pF}$	4.5	-	-	15	-	19	-	22	ns
Input Capacitance	$C_{IN}$	$C_L = 15\text{pF}$	-	-	-	10	-	10	-	10	pF
Power Dissipation Capacitance (Notes 4, 5)	$C_{PD}$	$C_L = 15\text{pF}$	5	-	30	-	-	-	-	-	pF

**NOTES:**

- $C_{PD}$  is used to determine the dynamic power consumption, per package.
- $P_D = V_{CC}^2 f_i + \sum (C_L V_{CC}^2 f_i / M)$  where:  $M = 2^1, 2^2, 2^3, 2^4, 2^5, 2^6, 2^7$   $f_i$  = Input Frequency,  $C_L$  = Output Load Capacitance,  $V_{CC}$  = Supply Voltage.

## Test Circuits and Waveforms

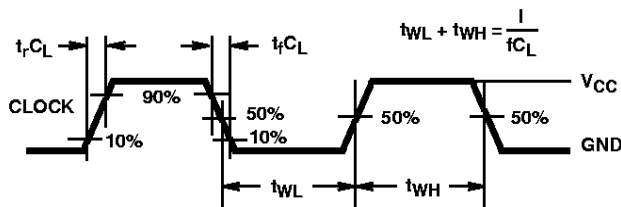

NOTE: Outputs should be switching from 10%  $V_{CC}$  to 90%  $V_{CC}$  in accordance with device truth table. For  $f_{MAX}$ , input duty cycle = 50%.

**FIGURE 1. HC CLOCK PULSE RISE AND FALL TIMES AND PULSE WIDTH**

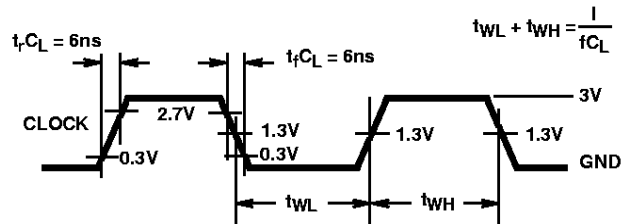

NOTE: Outputs should be switching from 10%  $V_{CC}$  to 90%  $V_{CC}$  in accordance with device truth table. For  $f_{MAX}$ , input duty cycle = 50%.

**FIGURE 2. HCT CLOCK PULSE RISE AND FALL TIMES AND PULSE WIDTH**

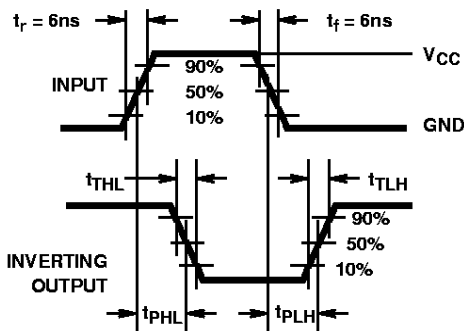

**FIGURE 3. HC AND HCU TRANSITION TIMES AND PROPAGATION DELAY TIMES, COMBINATION LOGIC**

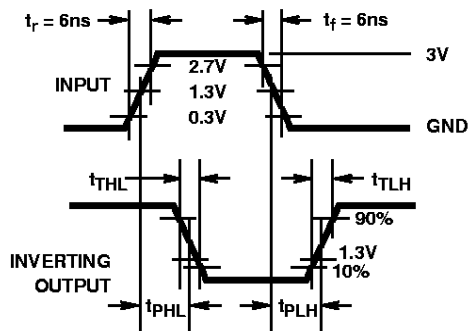

**FIGURE 4. HCT TRANSITION TIMES AND PROPAGATION DELAY TIMES, COMBINATION LOGIC**