

# NL17SZ02

## 2-Input NOR Gate

The NL17SZ02 is a single 2-input NOR Gate in two tiny footprint packages. The device performs much as LCX multi-gate products in speed and drive.

### Features

- Tiny SOT-353 and SOT-553 Packages
- 2.4 ns  $T_{PD}$  at 5 V (typ)
- Source/Sink 24 mA at 3.0 V
- Over-Voltage Tolerant Inputs
- Pin For Pin with NC7SZ02P5X, TC7SZ02FU and TC7SZ02AFE
- Chip Complexity: FETs = 20
- Designed for 1.65 V to 5.5 V  $V_{CC}$  Operation
- Pb-Free Packages are Available

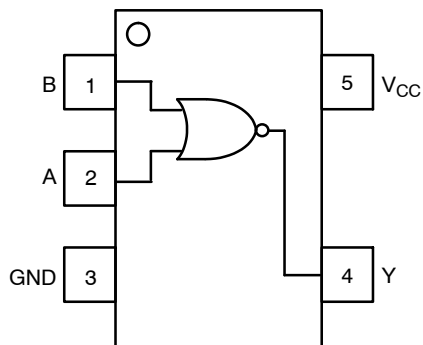

Figure 1. Pinout (Top View)

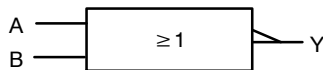
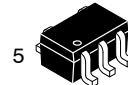

Figure 2. Logic Symbol



**ON Semiconductor®**

<http://onsemi.com>



SOT-353/SC70-5/SC-88A  
DF SUFFIX  
CASE 419A

### MARKING DIAGRAMS

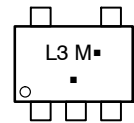

L3 = Specific Device Marking  
M = Date Code  
■ = Pb-Free Package  
(Note: Microdot may be in either location)

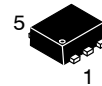

SOT-553  
XV5 SUFFIX  
CASE 463B

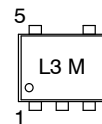

L3 = Specific Device Marking  
M = Date Code

### PIN ASSIGNMENT

| Pin | Function |
|-----|----------|
| 1   | A        |
| 2   | B        |
| 3   | GND      |
| 4   | Y        |
| 5   | $V_{CC}$ |

### FUNCTION TABLE

| Input |   | Output<br>$Y = \overline{A + B}$ |
|-------|---|----------------------------------|
| A     | B | Y                                |
| L     | L | H                                |
| L     | H | L                                |
| H     | L | L                                |
| H     | H | L                                |

### ORDERING INFORMATION

See detailed ordering and shipping information in the package dimensions section on page 4 of this data sheet.

# NL17SZ02

## MAXIMUM RATINGS

| Symbol           | Parameter                                       | Value  | Unit                      |
|------------------|---|--|---------------------------|
| V <sub>CC</sub>  | DC Supply Voltage                               | - 0.5 to +7.0  | V                         |
| V <sub>IN</sub>  | DC Input Voltage                                | - 0.5 to +7.0  | V                         |
| V <sub>OUT</sub> | DC Output Voltage                               | - 0.5 to V <sub>CC</sub> + 0.5   | V                         |
| I <sub>IK</sub>  | DC Input Diode Current                          | - 50   | mA                        |
| I <sub>OK</sub>  | DC Output Diode Current                         | - 50   | mA                        |
| I <sub>OUT</sub> | DC Output Sink Current                          | ± 50   | mA                        |
| I <sub>CC</sub>  | DC Supply Current per Supply Pin                | ± 100  | mA                        |
| T <sub>STG</sub> | Storage Temperature Range                       | - 65 to + 150  | °C                        |
| T <sub>L</sub>   | Lead Temperature, 1 mm from Case for 10 Seconds | 260  | °C                        |
| T <sub>J</sub>   | Junction Temperature Under Bias                 | + 150  | °C                        |
| θ <sub>JA</sub>  | Thermal Resistance                              | SOT-353 (Note 1)<br>SOT-553<br>350<br>496  | °C/W                      |
| P <sub>D</sub>   | Power Dissipation in Still Air at 85°C          | SOT-353<br>SOT-553<br>186<br>135   | mW                        |
| MSL              | Moisture Sensitivity                            | Level 1  |                           |
| F <sub>R</sub>   | Flammability Rating                             | Oxygen Index: 28 to 34   | UL 94 V-0 @ 0.125 in      |
| ESD              | ESD Classification                              | Human Body Model (Note 2)<br>Machine Model (Note 3)<br>Charged Device Model (Note 4) | Class Z<br>Class A<br>N/A |

Stresses exceeding Maximum Ratings may damage the device. Maximum Ratings are stress ratings only. Functional operation above the Recommended Operating Conditions is not implied. Extended exposure to stresses above the Recommended Operating Conditions may affect device reliability.

1. Measured with minimum pad spacing on an FR4 board, using 10 mm-by-1 inch, 2-ounce copper trace with no air flow.
2. Tested to EIA/JESD22-A114-A, rated to EIA/JESD22-A114-B.
3. Tested to EIA/JESD22-A115-A, rated to EIA/JESD22-A115-A.
4. Tested to JESD22-C101-A.

## RECOMMENDED OPERATING CONDITIONS

| Symbol                          | Parameter                   | Min  | Max                   | Unit |
|---------------------------------|-----------------------------|--|-----------------------|------|
| V <sub>CC</sub>                 | DC Supply Voltage           | 1.65   | 5.5                   | V    |
| V <sub>IN</sub>                 | DC Input Voltage            | 0  | 5.5                   | V    |
| V <sub>OUT</sub>                | DC Output Voltage           | 0  | V <sub>CC</sub> + 0.5 | V    |
| T <sub>A</sub>                  | Operating Temperature Range | -55  | +125                  | °C   |
| t <sub>p</sub> , t <sub>f</sub> | Input Rise and Fall Time    | V <sub>CC</sub> = 3.0 V ± 0.3 V<br>V <sub>CC</sub> = 5.0 V ± 0.5 V | 0<br>100              | ns/V |
|                                 |                             |  | 0<br>20               |      |

# NL17SZ02

## DC ELECTRICAL CHARACTERISTICS

| Symbol          | Parameter   | Condition  | V <sub>CC</sub><br>(V)                                 | T <sub>A</sub> = 25°C  |  |  | -55°C ≤ T <sub>A</sub> ≤ 125°C                                   |  | Unit |
|-----------------|---|--|--|--|--|--|--|--|------|
|                 |   |  |  | Min  | Typ  | Max  | Min  | Max  |      |
| V <sub>IH</sub> | High-Level Input Voltage  |  | 1.65 to 1.95<br>2.3 to 5.5                             | 0.75 V <sub>CC</sub><br>0.7 V <sub>CC</sub>                      |  |  | 0.75 V <sub>CC</sub><br>0.7 V <sub>CC</sub>                      |  | V    |
| V <sub>IL</sub> | Low-Level Input Voltage   |  | 1.65 to 1.95<br>2.3 to 5.5                             |  |  | 0.25 V <sub>CC</sub><br>0.3 V <sub>CC</sub>      |  | 0.25 V <sub>CC</sub><br>0.3 V <sub>CC</sub>      | V    |
| V <sub>OH</sub> | High-Level Output Voltage<br>V <sub>IN</sub> = V <sub>IL</sub> or V <sub>IH</sub> | I <sub>OH</sub> = 100 μA<br>I <sub>OH</sub> = -3 mA<br>I <sub>OH</sub> = -8 mA<br>I <sub>OH</sub> = -12 mA<br>I <sub>OH</sub> = -16 mA<br>I <sub>OH</sub> = -24 mA<br>I <sub>OH</sub> = -32 mA | 1.65 to 5.5<br>1.65<br>2.3<br>2.7<br>3.0<br>3.0<br>4.5 | V <sub>CC</sub> - 0.1<br>1.29<br>1.9<br>2.2<br>2.4<br>2.3<br>3.8 | V <sub>CC</sub><br>1.52<br>2.1<br>2.4<br>2.7<br>2.5<br>4.0 |  | V <sub>CC</sub> - 0.1<br>1.29<br>1.9<br>2.2<br>2.4<br>2.3<br>3.8 |  | V    |
| V <sub>OL</sub> | Low-Level Output Voltage<br>V <sub>IN</sub> = V <sub>IH</sub> or V <sub>OH</sub>  | I <sub>OL</sub> = 100 μA<br>I <sub>OL</sub> = 3 mA<br>I <sub>OL</sub> = 8 mA<br>I <sub>OL</sub> = 12 mA<br>I <sub>OL</sub> = 16 mA<br>I <sub>OL</sub> = 24 mA<br>I <sub>OL</sub> = 32 mA       | 1.65 to 5.5<br>1.65<br>2.3<br>2.7<br>3.0<br>3.0<br>4.5 |  | 0.08<br>0.20<br>0.22<br>0.28<br>0.38<br>0.42               | 0.1<br>0.24<br>0.3<br>0.4<br>0.4<br>0.55<br>0.55 |  | 0.1<br>0.24<br>0.3<br>0.4<br>0.4<br>0.55<br>0.55 | V    |
| I <sub>IN</sub> | Input Leakage Current   | V <sub>IN</sub> = V <sub>CC</sub> or GND   | 0 to 5.5   |  |  | ±0.1   |  | ±1.0   | μA   |
| I <sub>CC</sub> | Quiescent Supply Current  | V <sub>IN</sub> = V <sub>CC</sub> or GND   | 5.5  |  |  | 1  |  | 10   | μA   |

## AC ELECTRICAL CHARACTERISTICS t<sub>R</sub> = t<sub>F</sub> = 3.0 ns

| Symbol                               | Parameter                             | Condition   | V <sub>CC</sub><br>(V) | T <sub>A</sub> = 25°C |     |      | -55°C ≤ T <sub>A</sub> ≤ 125°C |      | Unit |
|--------------------------------------|---------------------------------------|---|------------------------|-----------------------|-----|------|--------------------------------|------|------|
|                                      |                                       |   |                        | Min                   | Typ | Max  | Min                            | Max  |      |
| t <sub>PLH</sub><br>t <sub>PHL</sub> | Propagation Delay<br>(Figure 3 and 4) | R <sub>L</sub> = 1 MΩ, C <sub>L</sub> = 15 pF   | 1.65                   | 2.0                   | 5.3 | 11.5 | 2.0                            | 12.0 | ns   |
|                                      |                                       | R <sub>L</sub> = 1 MΩ, C <sub>L</sub> = 15 pF   | 1.8                    | 2.0                   | 4.4 | 9.5  | 2.0                            | 10.0 |      |
|                                      |                                       | R <sub>L</sub> = 1 MΩ, C <sub>L</sub> = 15 pF   | 2.5 ± 0.2              | 0.8                   | 2.9 | 6.5  | 0.8                            | 7.0  |      |
|                                      |                                       | R <sub>L</sub> = 1 MΩ, C <sub>L</sub> = 15 pF   | 3.3 ± 0.3              | 0.5                   | 2.3 | 4.5  | 0.5                            | 4.7  |      |
|                                      |                                       | R <sub>L</sub> = 500 Ω, C <sub>L</sub> = 50 pF  |                        | 1.5                   | 2.9 | 5.0  | 1.5                            | 5.2  |      |
|                                      |                                       | R <sub>L</sub> = 1 MΩ, C <sub>L</sub> = 15 pF<br>R <sub>L</sub> = 500 Ω, C <sub>L</sub> = 50 pF | 5.0 ± 0.5              | 0.5                   | 1.9 | 3.9  | 0.5                            | 4.1  |      |

## CAPACITIVE CHARACTERISTICS

| Symbol          | Parameter                                 | Condition  | Typical  | Unit |
|-----------------|---|--|----------|------|
| C <sub>IN</sub> | Input Capacitance                         | V <sub>CC</sub> = 5.5 V, V <sub>I</sub> = 0 V or V <sub>CC</sub>   | > 4      | pF   |
| C <sub>PD</sub> | Power Dissipation Capacitance<br>(Note 5) | 10 MHz, V <sub>CC</sub> = 3.3 V, V <sub>I</sub> = 0 V or V <sub>CC</sub><br>10 MHz, V <sub>CC</sub> = 5.5 V, V <sub>I</sub> = 0 V or V <sub>CC</sub> | 25<br>30 | pF   |

5. C<sub>PD</sub> is defined as the value of the internal equivalent capacitance which is calculated from the operating current consumption without load. Average operating current can be obtained by the equation: I<sub>CC(OPR)</sub> = C<sub>PD</sub> • V<sub>CC</sub> • f<sub>in</sub> + I<sub>CC</sub>. C<sub>PD</sub> is used to determine the no-load dynamic power consumption; P<sub>D</sub> = C<sub>PD</sub> • V<sub>CC</sub><sup>2</sup> • f<sub>in</sub> + I<sub>CC</sub> • V<sub>CC</sub>.

# NL17SZ02

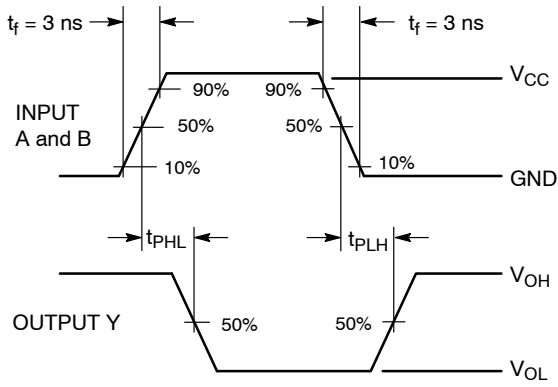
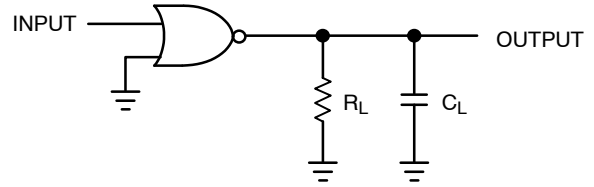

Figure 3. Switching Waveform



A 1-MHz square input wave is recommended for propagation delay tests.

Figure 4. Test Circuit

## DEVICE ORDERING INFORMATION

| Device Order Number | Device Nomenclature     |                          |                       |            |                 |                |                      | Package Type                               | Tape and Reel Size <sup>†</sup> |
|---------------------|-------------------------|--------------------------|-----------------------|------------|-----------------|----------------|----------------------|--|---------------------------------|
|                     | Logic Circuit Indicator | No. of Gates per Package | Temp Range Identifier | Technology | Device Function | Package Suffix | Tape and Reel Suffix |  |                                 |
| NL17SZ02DFT2        | NL                      | 1                        | 7                     | SZ         | 02              | DF             | T2                   | SOT-353/<br>SC70-5/<br>SC-88A              | 178 mm,<br>3000 Units           |
| NL17SZ02DFT2G       | NL                      | 1                        | 7                     | SZ         | 02              | DF             | T2                   | SOT-353/<br>SC70-5/<br>SC-88A<br>(Pb-Free) | 178 mm,<br>3000 Units           |
| NL17SZ02XV5T2       | NL                      | 1                        | 7                     | SZ         | 02              | XV5            | T2                   | SOT-553*                                   | 178 mm<br>4000 Units            |

<sup>†</sup>For information on tape and reel specifications, including part orientation and tape sizes, please refer to our Tape and Reel Packaging Specifications Brochure, BRD8011/D.

\*All Devices in Package SOT553 are Inherently Pb-Free.

# NL17SZ02

## PACKAGE DIMENSIONS

SOT-353  
(SC-88A, SC-70)  
DF SUFFIX  
CASE 419A-02  
ISSUE J

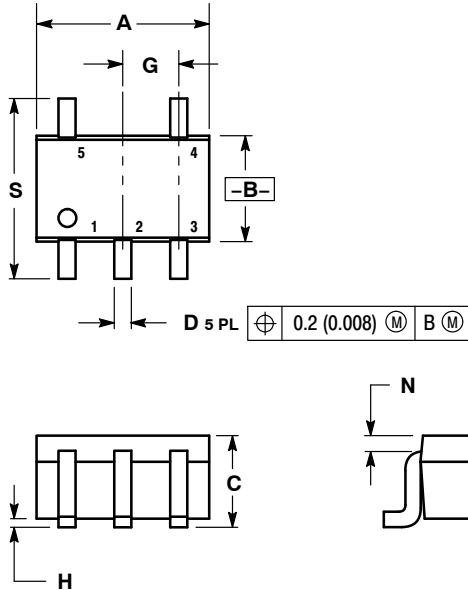

NOTES:

1. DIMENSIONING AND TOLERANCING PER ANSI Y14.5M, 1982.
2. CONTROLLING DIMENSION: INCH.
3. 419A-01 OBSOLETE. NEW STANDARD 419A-02.
4. DIMENSIONS A AND B DO NOT INCLUDE MOLD FLASH, PROTRUSIONS, OR GATE BURRS.

| DIM | INCHES    |       | MILLIMETERS |      |
|-----|-----------|-------|-------------|------|
|     | MIN       | MAX   | MIN         | MAX  |
| A   | 0.071     | 0.087 | 1.80        | 2.20 |
| B   | 0.045     | 0.053 | 1.15        | 1.35 |
| C   | 0.031     | 0.043 | 0.80        | 1.10 |
| D   | 0.004     | 0.012 | 0.10        | 0.30 |
| G   | 0.026 BSC |       | 0.65 BSC    |      |
| H   | ---       | 0.004 | ---         | 0.10 |
| J   | 0.004     | 0.010 | 0.10        | 0.25 |
| K   | 0.004     | 0.012 | 0.10        | 0.30 |
| N   | 0.008 REF |       | 0.20 REF    |      |
| S   | 0.079     | 0.087 | 2.00        | 2.20 |

### SOLDERING FOOTPRINT\*

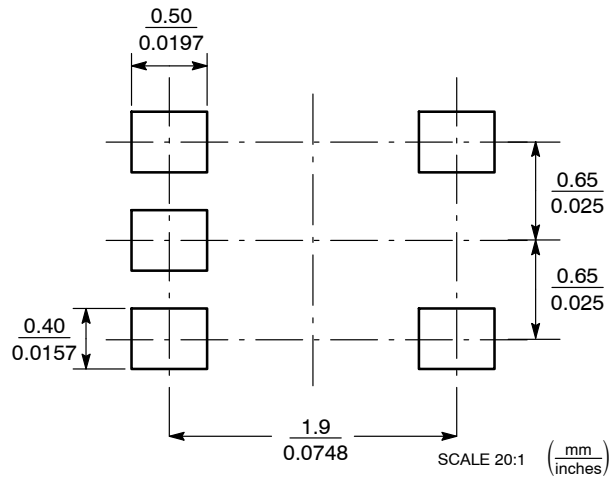

\*For additional information on our Pb-Free strategy and soldering details, please download the ON Semiconductor Soldering and Mounting Techniques Reference Manual, SOLDERRM/D.

# NL17SZ02

## PACKAGE DIMENSIONS

SOT-553  
XV5 SUFFIX  
CASE 463B-01  
ISSUE B

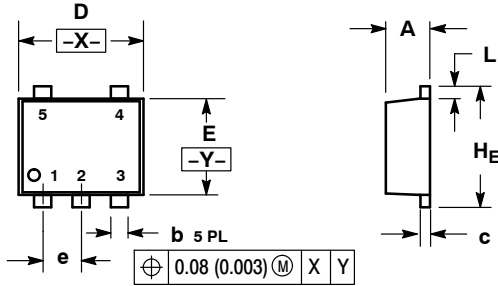

### NOTES:

1. DIMENSIONING AND TOLERANCING PER ANSI Y14.5M, 1982.
2. CONTROLLING DIMENSION: MILLIMETERS
3. MAXIMUM LEAD THICKNESS INCLUDES LEAD FINISH THICKNESS. MINIMUM LEAD THICKNESS IS THE MINIMUM THICKNESS OF BASE MATERIAL.

| DIM | MILLIMETERS |      |      | INCHES    |       |       |
|-----|-------------|------|------|-----------|-------|-------|
|     | MIN         | NOM  | MAX  | MIN       | NOM   | MAX   |
| A   | 0.50        | 0.55 | 0.60 | 0.020     | 0.022 | 0.024 |
| b   | 0.17        | 0.22 | 0.27 | 0.007     | 0.009 | 0.011 |
| c   | 0.08        | 0.13 | 0.18 | 0.003     | 0.005 | 0.007 |
| D   | 1.50        | 1.60 | 1.70 | 0.059     | 0.063 | 0.067 |
| E   | 1.10        | 1.20 | 1.30 | 0.043     | 0.047 | 0.051 |
| e   | 0.50 BSC    |      |      | 0.020 BSC |       |       |
| L   | 0.10        | 0.20 | 0.30 | 0.004     | 0.008 | 0.012 |
| HE  | 1.50        | 1.60 | 1.70 | 0.059     | 0.063 | 0.067 |

### SOLDERING FOOTPRINT\*

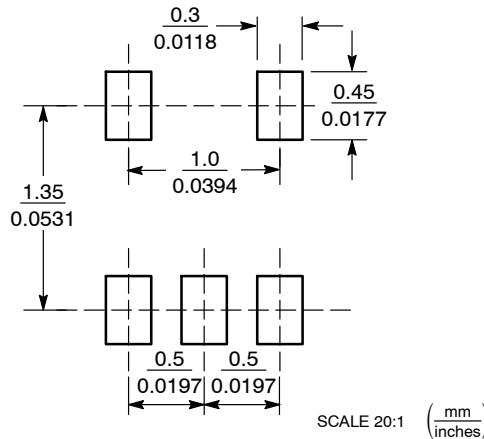

\*For additional information on our Pb-Free strategy and soldering details, please download the ON Semiconductor Soldering and Mounting Techniques Reference Manual, SOLDERRM/D.

ON Semiconductor and are registered trademarks of Semiconductor Components Industries, LLC (SCILLC). SCILLC reserves the right to make changes without further notice to any products herein. SCILLC makes no warranty, representation or guarantee regarding the suitability of its products for any particular purpose, nor does SCILLC assume any liability arising out of the application or use of any product or circuit, and specifically disclaims any and all liability, including without limitation special, consequential or incidental damages. "Typical" parameters which may be provided in SCILLC data sheets and/or specifications can and do vary in different applications and actual performance may vary over time. All operating parameters, including "Typicals" must be validated for each customer application by customer's technical experts. SCILLC does not convey any license under its patent rights nor the rights of others. SCILLC products are not designed, intended, or authorized for use as components in systems intended for surgical implant into the body, or other applications intended to support or sustain life, or for any other application in which the failure of the SCILLC product could create a situation where personal injury or death may occur. Should Buyer purchase or use SCILLC products for any such unintended or unauthorized application, Buyer shall indemnify and hold SCILLC and its officers, employees, subsidiaries, affiliates, and distributors harmless against all claims, costs, damages, and expenses, and reasonable attorney fees arising out of, directly or indirectly, any claim of personal injury or death associated with such unintended or unauthorized use, even if such claim alleges that SCILLC was negligent regarding the design or manufacture of the part. SCILLC is an Equal Opportunity/Affirmative Action Employer. This literature is subject to all applicable copyright laws and is not for resale in any manner.

### PUBLICATION ORDERING INFORMATION

LITERATURE FULFILLMENT:  
Literature Distribution Center for ON Semiconductor  
P.O. Box 5163, Denver, Colorado 80217 USA  
Phone: 303-675-2175 or 800-344-3860 Toll Free USA/Canada  
Fax: 303-675-2176 or 800-344-3867 Toll Free USA/Canada  
Email: orderlit@onsemi.com

N. American Technical Support: 800-282-9855 Toll Free  
USA/Canada  
Europe, Middle East and Africa Technical Support:  
Phone: 421 33 790 2910  
Japan Customer Focus Center  
Phone: 81-3-5773-3850

ON Semiconductor Website: [www.onsemi.com](http://www.onsemi.com)

Order Literature: <http://www.onsemi.com/orderlit>

For additional information, please contact your local Sales Representative