

## N-channel 650 V, 0.012 $\Omega$ typ., 143 A MDmesh™ M5 Power MOSFET in an ISOTOP package

Datasheet - production data

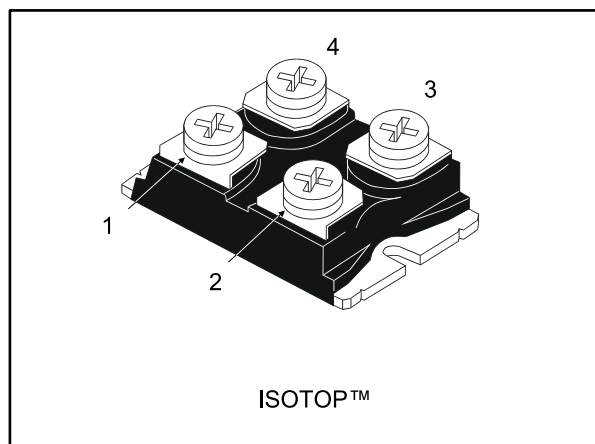
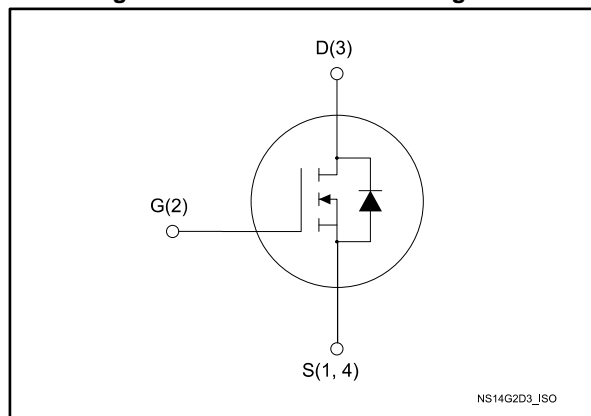

Figure 1: Internal schematic diagram



### Features

Order code	$V_{DS}$ @ $T_{Jmax}$	$R_{DS(on)}$ max.	$I_D$
STE145N65M5	710 V	0.015 $\Omega$	143 A

- Extremely low  $R_{DS(on)}$
- Low gate charge and input capacitance
- Excellent switching performance
- 100% avalanche tested

### Applications

- Switching applications

### Description

This device is an N-channel Power MOSFET based on the MDmesh™ M5 innovative vertical process technology combined with the well-known PowerMESH™ horizontal layout. The resulting product offers extremely low on-resistance, making it particularly suitable for applications requiring high power and superior efficiency.

Table 1: Device summary

Order code	Marking	Package	Packaging
STE145N65M5	145N65M5	ISOTOP	Tube

---

**Contents**

<b>1</b>	<b>Electrical ratings .....</b>	<b>3</b>
<b>2</b>	<b>Electrical characteristics .....</b>	<b>4</b>
	2.1 Electrical characteristics (curves) .....	6
<b>3</b>	<b>Test circuits .....</b>	<b>8</b>
<b>4</b>	<b>Package information .....</b>	<b>9</b>
	4.1 ISOTOP package information .....	10
<b>5</b>	<b>Revision history .....</b>	<b>12</b>

# 1 Electrical ratings

Table 2: Absolute maximum ratings

Symbol	Parameter	Value	Unit
$V_{GS}$	Gate-source voltage	$\pm 25$	V
$I_D$	Drain current (continuous) at $T_C = 25\text{ °C}$	143	A
$I_D$	Drain current (continuous) at $T_C = 100\text{ °C}$	90	A
$I_{DM}^{(1)}$	Drain current (pulsed)	572	A
$P_{TOT}$	Total dissipation at $T_C = 25\text{ °C}$	679	W
$I_{AR}$	Avalanche current, repetitive or not repetitive (pulse width limited by $T_j$ max)	12	A
$E_{AS}$	Single pulse avalanche energy (starting $T_j = 25\text{ °C}$ , $I_D = I_{AR}$ , $V_{DD} = 50\text{ V}$ )	2420	mJ
$dv/dt^{(2)}$	Peak diode recovery voltage slope	15	V/ns
$V_{ISO}$	Isolation withstand voltage applied between each pin and heatsink plate (AC voltage, $t = 60\text{ s}$ )	2.5	kV
$T_{stg}$	Storage temperature	- 55 to 150	°C
$T_j$	Max. operating junction temperature	150	

**Notes:**

<sup>(1)</sup>Pulse width limited by safe operating area.

<sup>(2)</sup> $I_{SD} \leq 143\text{ A}$ ,  $di/dt \leq 400\text{ A}/\mu\text{s}$ ;  $V_{DS(\text{peak})} < V_{(BR)DSS}$ ,  $V_{DD} = 400\text{ V}$ .

Table 3: Thermal data

Symbol	Parameter	Value	Unit
$R_{thj\text{-case}}$	Thermal resistance junction-case max	0.184	°C/W
$R_{thj\text{-amb}}$	Thermal resistance junction-ambient max	30	°C/W

## 2 Electrical characteristics

$T_C = 25\text{ °C}$  unless otherwise specified

**Table 4: On/off states**

Symbol	Parameter	Test conditions	Min.	Typ.	Max.	Unit
$V_{(BR)DSS}$	Drain-source breakdown voltage	$V_{GS} = 0\text{ V}$ , $I_D = 1\text{ mA}$	650			V
$I_{DSS}$	Zero gate voltage drain current	$V_{GS} = 0\text{ V}$ , $V_{DS} = 650\text{ V}$			10	$\mu\text{A}$
		$V_{GS} = 0\text{ V}$ , $V_{DS} = 650\text{ V}$ , $T_C = 125\text{ °C}$			100	$\mu\text{A}$
$I_{GSS}$	Gate-body leakage current	$V_{DS} = 0\text{ V}$ , $V_{GS} = \pm 25\text{ V}$			$\pm 100$	nA
$V_{GS(th)}$	Gate threshold voltage	$V_{DS} = V_{GS}$ , $I_D = 250\text{ }\mu\text{A}$	3	4	5	V
$R_{DS(on)}$	Static drain-source on-resistance	$V_{GS} = 10\text{ V}$ , $I_D = 69\text{ A}$		0.012	0.015	$\Omega$

**Table 5: Dynamic**

Symbol	Parameter	Test conditions	Min.	Typ.	Max.	Unit
$C_{iss}$	Input capacitance	$V_{DS} = 100\text{ V}$ , $f = 1\text{ MHz}$ , $V_{GS} = 0\text{ V}$	-	18500	-	pF
$C_{oss}$	Output capacitance		-	413	-	pF
$C_{rss}$	Reverse transfer capacitance		-	11	-	pF
$C_{o(er)}^{(1)}$	Equivalent output capacitance energy related	$V_{GS} = 0$ , $V_{DS} = 0\text{ to }520\text{ V}$	-	415	-	pF
$C_{o(tr)}^{(2)}$	Equivalent output capacitance time related		-	1950	-	pF
$R_G$	Intrinsic gate resistance	$f = 1\text{ MHz}$ , open drain	-	0.7	-	$\Omega$
$Q_g$	Total gate charge	$V_{DD} = 520\text{ V}$ , $I_D = 69\text{ A}$ , $V_{GS} = 10\text{ V}$ (see <a href="#">Figure 15: "Test circuit for gate charge behavior"</a> )	-	414	-	nC
$Q_{gs}$	Gate-source charge		-	114	-	nC
$Q_{gd}$	Gate-drain charge		-	164	-	nC

**Notes:**

<sup>(1)</sup> $C_{o(er)}$  is defined as a constant equivalent capacitance giving the same stored energy as  $C_{oss}$  when  $V_{DS}$  increases from 0 to 80%  $V_{DSS}$

<sup>(2)</sup> $C_{o(tr)}$  is defined as a constant equivalent capacitance giving the same charging time as  $C_{oss}$  when  $V_{DS}$  increases from 0 to 80%  $V_{DSS}$

Table 6: Switching times

Symbol	Parameter	Test conditions	Min.	Typ.	Max.	Unit
$t_{d(V)}$	Voltage delay time	$V_{DD} = 400\text{ V}$ , $I_D = 85\text{ A}$ $R_G = 4.7\ \Omega$ , $V_{GS} = 10\text{ V}$ (see <i>Figure 16: "Test circuit for inductive load switching and diode recovery times"</i> and <i>Figure 19: "Switching time waveform"</i> )	-	255	-	ns
$t_{r(V)}$	Voltage rise time		-	11	-	ns
$t_{f(i)}$	Current fall time		-	82	-	ns
$t_{C(off)}$	Crossing time		-	88	-	ns

Table 7: Source drain diode

Symbol	Parameter	Test conditions	Min.	Typ.	Max.	Unit
$I_{SD}$	Source-drain current		-		143	A
$I_{SDM}^{(1)}$	Source-drain current (pulsed)		-		572	A
$V_{SD}^{(2)}$	Forward on voltage	$V_{GS} = 0\text{ V}$ , $I_{SD} = 143\text{ A}$	-		1.5	V
$t_{rr}$	Reverse recovery time	$I_{SD} = 143\text{ A}$ , $di/dt = 100\text{ A}/\mu\text{s}$ , $V_{DD} = 100\text{ V}$ (see <i>Figure 16: "Test circuit for inductive load switching and diode recovery times"</i> )	-	568		ns
$Q_{rr}$	Reverse recovery charge		-	14.5		$\mu\text{C}$
$I_{RRM}$	Reverse recovery current		-	51		A
$t_{rr}$	Reverse recovery time	$I_{SD} = 143\text{ A}$ , $di/dt = 100\text{ A}/\mu\text{s}$ , $V_{DD} = 100\text{ V}$ , $T_j = 150\text{ }^\circ\text{C}$ (see <i>Figure 16: "Test circuit for inductive load switching and diode recovery times"</i> )	-	728		ns
$Q_{rr}$	Reverse recovery charge		-	24.5		$\mu\text{C}$
$I_{RRM}$	Reverse recovery current		-	67		A

**Notes:**

<sup>(1)</sup>Pulse width is limited by safe operating area

<sup>(2)</sup>Pulsed: pulse duration = 300  $\mu\text{s}$ , duty cycle 1.5%

## 2.2 Electrical characteristics (curves)

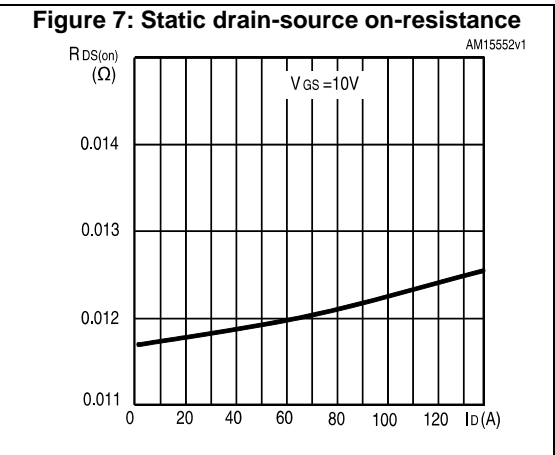
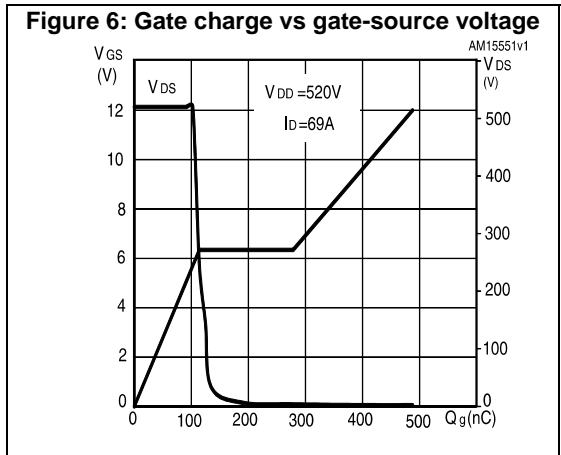
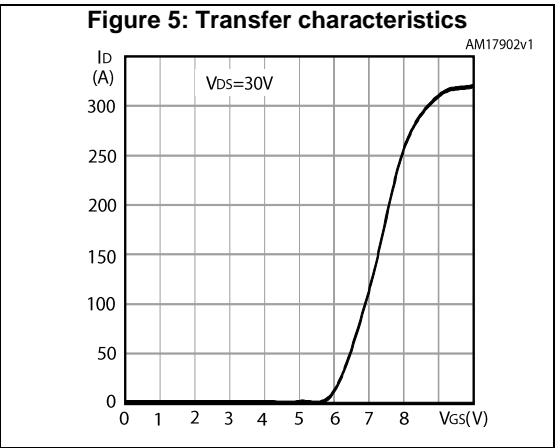
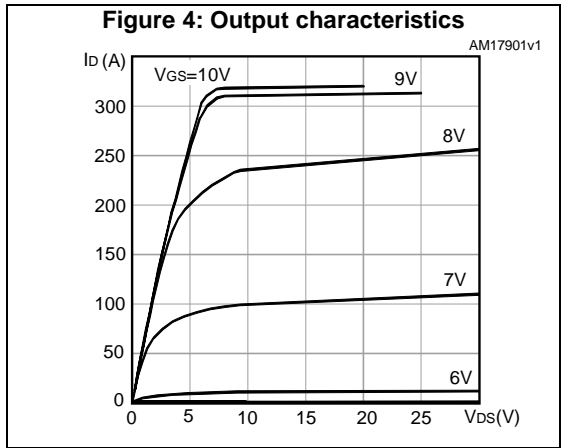
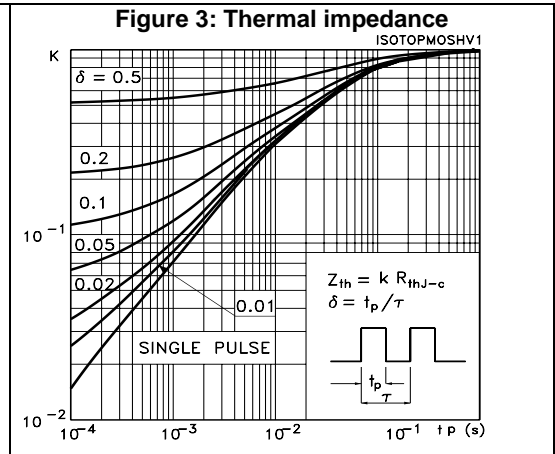
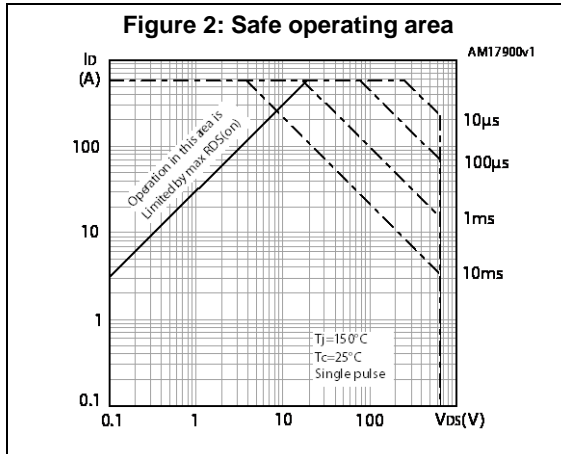

Figure 8: Capacitance variations

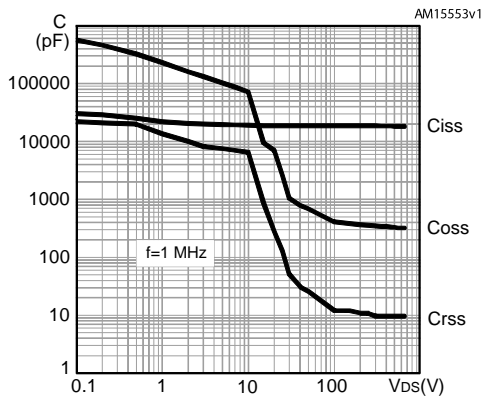

Figure 9: Normalized gate threshold voltage vs temperature

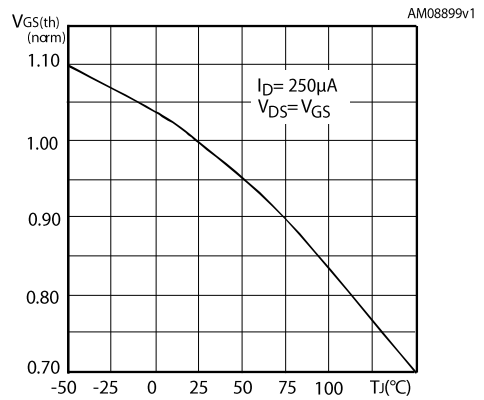

Figure 10: Normalized on-resistance vs temperature

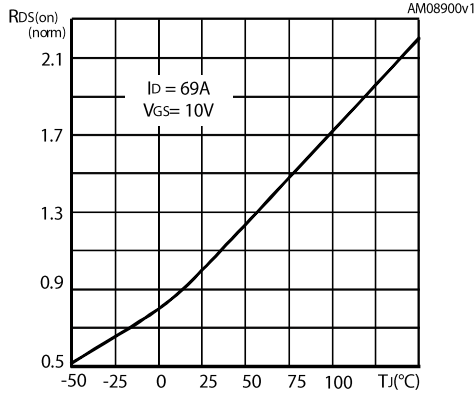

Figure 11: Normalized V(BR)DSS vs temperature

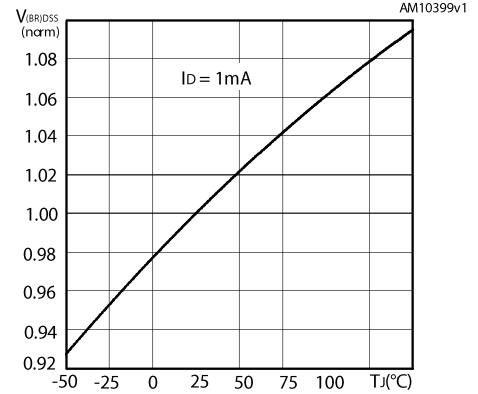

Figure 12: Output capacitance stored energy

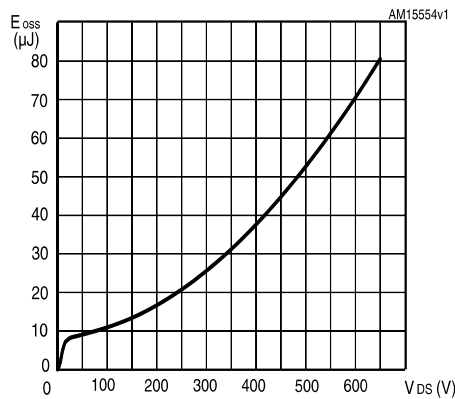
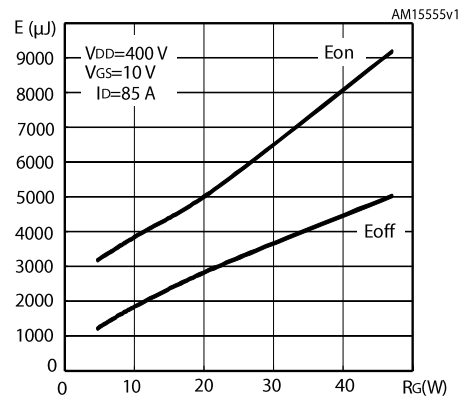

Figure 13: Switching losses vs gate resistance



The previous figure E<sub>on</sub> includes reverse recovery of a SiC diode.

### 3 Test circuits

**Figure 14: Test circuit for resistive load switching times**

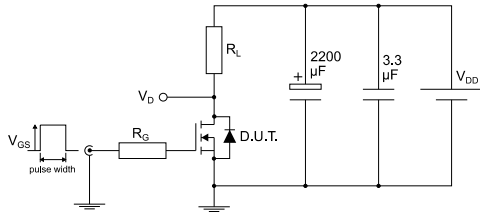

AM01468v1

**Figure 15: Test circuit for gate charge behavior**



AM01469v1

**Figure 16: Test circuit for inductive load switching and diode recovery times**



AM01470v1

**Figure 17: Unclamped inductive load test circuit**

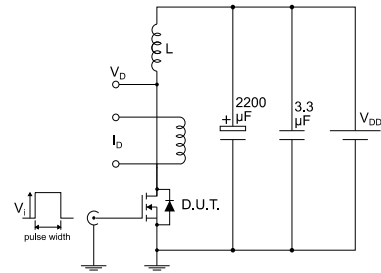

AM01471v1

**Figure 18: Unclamped inductive waveform**

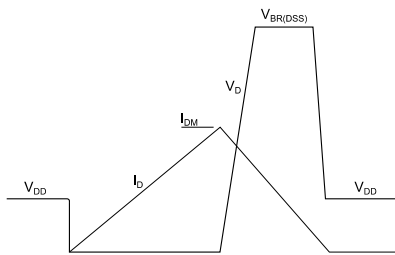

AM01472v1

**Figure 19: Switching time waveform**

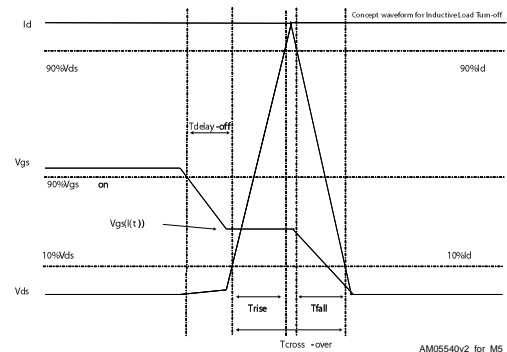

AM05540v2\_for\_M5



## 4 Package information

In order to meet environmental requirements, ST offers these devices in different grades of ECOPACK® packages, depending on their level of environmental compliance. ECOPACK® specifications, grade definitions and product status are available at: [www.st.com](http://www.st.com). ECOPACK® is an ST trademark.

### 4.1 ISOTOP package information

Figure 20: ISOTOP outline

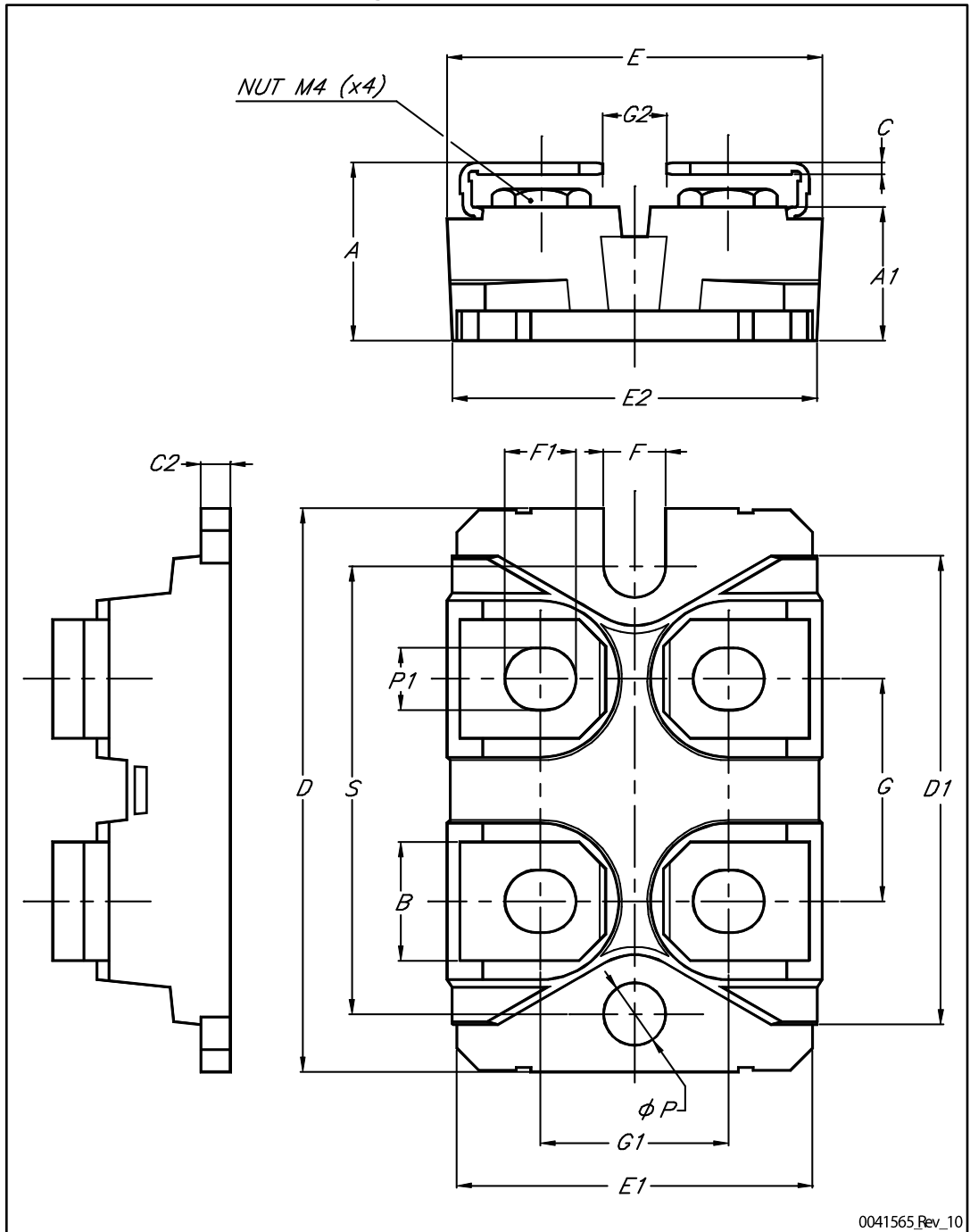

0041565\_Rev\_10

Table 8: ISOTOP mechanical data

Dim.	mm		
	Min.	Typ.	Max.
A	11.80		12.20
A1	8.90		9.10
B	7.80		8.20
C	0.75		0.85
C2	1.95		2.05
D	37.80		38.20
D1	31.50		31.70
E	25.15		25.50
E1	23.85		24.15
E2		24.80	
G	14.90		15.10
G1	12.60		12.80
G2	3.50		4.30
F	4.10		4.30
F1	4.60		5
ØP	4		4.30
P1	4		4.40
S	30.10		30.30

## 5 Revision history

**Table 9: Document revision history**

Date	Revision	Changes
18-Nov-2013	1	First release.
12-Nov-2015	2	Updated title, features and description on cover page. Document status promoted from preliminary to production data. Modified: <i>Table 2: "Absolute maximum ratings"</i> and <i>Figure 12: "Output capacitance stored energy"</i> Minor text changes.

**IMPORTANT NOTICE – PLEASE READ CAREFULLY**

STMicroelectronics NV and its subsidiaries ("ST") reserve the right to make changes, corrections, enhancements, modifications, and improvements to ST products and/or to this document at any time without notice. Purchasers should obtain the latest relevant information on ST products before placing orders. ST products are sold pursuant to ST's terms and conditions of sale in place at the time of order acknowledgement.

Purchasers are solely responsible for the choice, selection, and use of ST products and ST assumes no liability for application assistance or the design of Purchasers' products.

No license, express or implied, to any intellectual property right is granted by ST herein.

Resale of ST products with provisions different from the information set forth herein shall void any warranty granted by ST for such product.

ST and the ST logo are trademarks of ST. All other product or service names are the property of their respective owners.

Information in this document supersedes and replaces information previously supplied in any prior versions of this document.

© 2015 STMicroelectronics – All rights reserved