

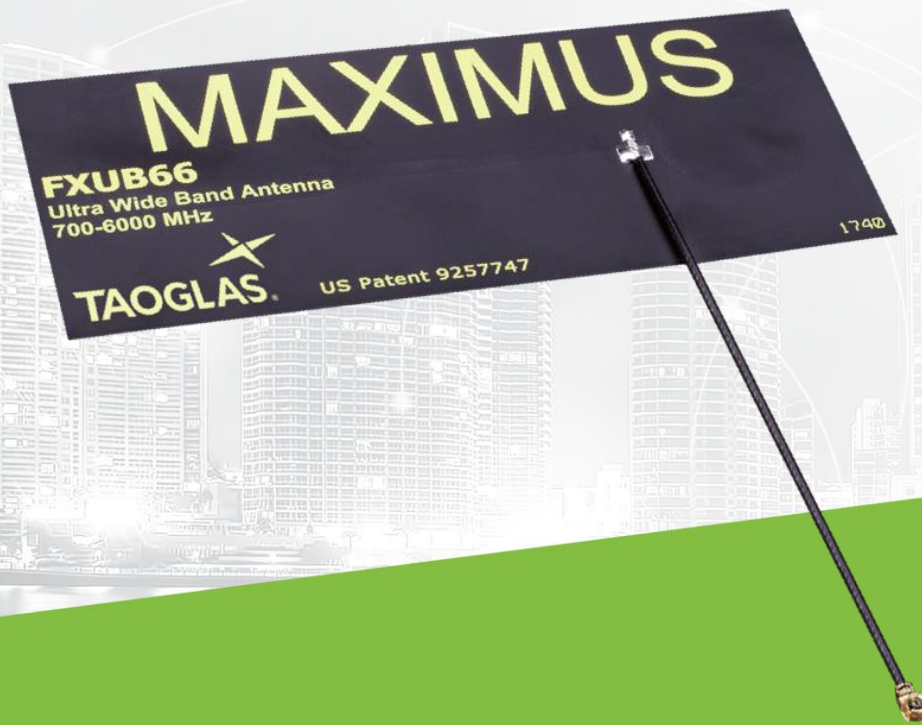

# TAOGLAS®



## Datasheet

### Maximus

Part No:  
FXUB66.07.0150C

### Description:

Flexible Wide Band 5G/4G Antenna 650-6000MHz

### Features:

- Ground Plane Independent
- 650-6000MHz
- 5G/4G Operational
- 5dBi Peak Gain
- Efficiencies above 50% on all cellular 2G/3G/4G/5G bands
- 120.4x50.4x0.2 mm size
- Connector: IPEX MHFHT U.FL Compatible
- Cable: 150mm 1.37
- RoHS & REACH Compliant

1. Introduction	3
2. Specifications	4
3. Antenna Characteristics	6
4. 2D Radiation Patterns	9
5. Mechanical Drawing	18
6. Packaging	19
<hr/>	
Changelog	23

Taoglas makes no warranties based on the accuracy or completeness of the contents of this document and reserves the right to make changes to specifications and product descriptions at any time without notice. Taoglas reserves all rights to this document and the information contained herein.

Reproduction, use or disclosure to third parties without express permission is strictly prohibited.



# 1. Introduction



The patent pending Maximus FXUB66 flexible wideband antenna has been designed to cover all working frequencies in the 650-6000 MHz spectrum, including all Cellular(5G/4G/3G/2G), Wi-Fi, ISM and GNSS bands. Its use in a device improves substantially the radiated power and sensitivity, and enables the highest throughput rates of today's broadband devices.

The antenna is delivered with a flexible body with ground breaking high efficiencies on all bands, ground-plane independent, with a cable and connector for easy installation. It is made of durable flexible polymer, with a peak gain of 5dBi, an efficiency of more than 60% across all cellular bands and is designed to be mounted directly onto a plastic or glass enclosure / cover.

At 120.4x50.4x2mm, the antenna is ultra thin. It is assembled by a simple “peel and stick” process, attaching securely to non-metal surfaces via 3M adhesive. It enables designers to use only one antenna that covers all frequencies and future proofs device design for 5G and 4G globally. It is also the ideal antenna to fit in devices that are being retrofitted with wireless functionality, as it will cover non cellular applications such as 868, 915MHz or Zigbee applications. Its inherently wide bandwidth is more resistant to detuning than traditional small but narrow-band legacy antennas.

The Maximus antenna has a unique hybrid design. Within one antenna structure the electromagnetic waves travel in two predominant propagation modes - one for lower frequencies, (e.g. 5G/4G at 650 MHz) and the other for higher 5G/4G and Wi-Fi frequencies up to 6GHz.

It is an ideal choice for any device maker that needs to keep manufacturing costs down over the lifetime of a product, as the same antenna can be used if the radio module is upgraded to work on a different frequency band.

Cables and Connectors are customizable.

## 2. Specifications

Electrical									
Frequency (MHz)	698-900	1390-1435	1575.42	1710-1990	1755-2170	2400-2500	2500-2700	3400-3600	4800-6000
Peak Gain (dBi)									
2mm ABS	2.7dBi	3.8dBi	5dBi	5dBi	5dBi	3.5dBi	3.8dBi	6.4dBi	5.5dBi
Average Gain (dB)									
2mm ABS	-0.97dB	-2.6dB	-1.1dB	-1dB	-1.8dB	-1.1dB	-1.1dB	-0.7dB	-2dB
Max VSWR									
2mm ABS	3.5:1	3.5:1	1.1:1	3:1	3.3:1	2.2:1	2:1	2.2:1	3:1
Max Return Loss(dB)									
2mm ABS	-5dB	-5dB	-20dB	-6dB	-5.5dB	-7dB	-10dB	-7dB	-6dB
Efficiency									
2mm ABS	80%	55%	75%	78%	65%	75%	75%	85%	60%
Impedance	50Ω								
Polarization	Linear								
Radiation Pattern	Omni-Directional								
Input Power	5 W								
Mechanical									
Dimensions	120.4 x 50.4 x 0.2 mm								
Material	Flexible Polymer								
Cable	150mm 1.37(Fully customizable)								
Connector	IPEX MHFI U.FL Compatible(Fully customizable)								
Environmental									
Operating Temperature	-40°C to 85°C								
Storage Temperature	-40°C to 85°C								
Relative Humidity	40% to 95%								
RoHS Compliant	Yes								

5G/4G Bands			
Band Number	5G NR / FR1 / LTE / LTE-Advanced / WCDMA / HSPA / HSPA+ / TD-SCDMA		
	Uplink	Downlink	Covered
1	UL: 1920 to 1980	DL: 2110 to 2170	✓
2	UL: 1850 to 1910	DL: 1930 to 1990	✓
3	UL: 1710 to 1785	DL: 1805 to 1880	✓
4	UL: 1710 to 1755	DL: 2110 to 2155	✓
5	UL: 824 to 849	DL: 869 to 894	✓
7	UL: 2500 to 2570	DL: 2620 to 2690	✓
8	UL: 880 to 915	DL: 925 to 960	✓
9	UL: 1749.9 to 1784.9	DL: 1844.9 to 1879.9	✓
11	UL: 1427.9 to 1447.9	DL: 1475.9 to 1495.9	✓
12	UL: 699 to 716	DL: 729 to 746	✓
13	UL: 777 to 787	DL: 746 to 756	✓
14	UL: 788 to 798	DL: 758 to 768	✓
17	UL: 704 to 716	DL: 734 to 746 (LTE only)	✓
18	UL: 815 to 830	DL: 860 to 875 (LTE only)	✓
19	UL: 830 to 845	DL: 875 to 890	✓
20	UL: 832 to 862	DL: 791 to 821	✓
21	UL: 1447.9 to 1462.9	DL: 1495.9 to 1510.9	✓
22	UL: 3410 to 3490	DL: 3510 to 3590	✓
23	UL: 2000 to 2020	DL: 2180 to 2200 (LTE only)	✓
24	UL: 1625.5 to 1660.5	DL: 1525 to 1559 (LTE only)	✓
25	UL: 1850 to 1915	DL: 1930 to 1995	✓
26	UL: 814 to 849	DL: 859 to 894	✓
27	UL: 807 to 824	DL: 852 to 869 (LTE only)	✓
28	UL: 703 to 748	DL: 758 to 803 (LTE only)	✓
29	UL: -	DL: 717 to 728 (LTE only)	✓
30	UL: 2305 to 2315	DL: 2350 to 2360 (LTE only)	✓
31	UL: 452.5 to 457.5	DL: 462.5 to 467.5 (LTE only)	✗
32	UL: -	DL: 1452 - 1496	✓
35		1850 to 1910	✓
38		2570 to 2620	✓
39		1880 to 1920	✓
40		2300 to 2400	✓
41		2496 to 2690	✓
42		3400 to 3600	✓
43		3600 to 3800	✓
48		3550 to 3700	✓
66	UL: 1710-1780	DL: 2110-2200	✓
71		617 to 698	✓
74/75/76		1427 to 1518	✓
78		3300 to 3800	✓
79		4400 to 5000	✓

### 3. Antenna Characteristics

#### 3.1 Return Loss

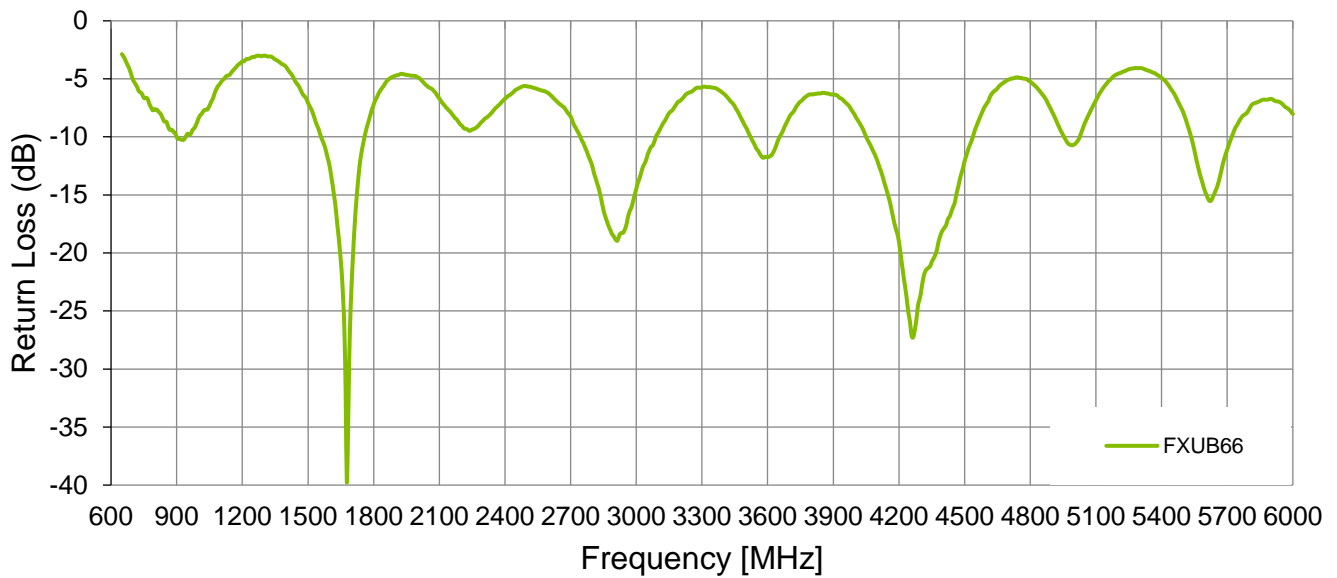

#### 3.2 VSWR

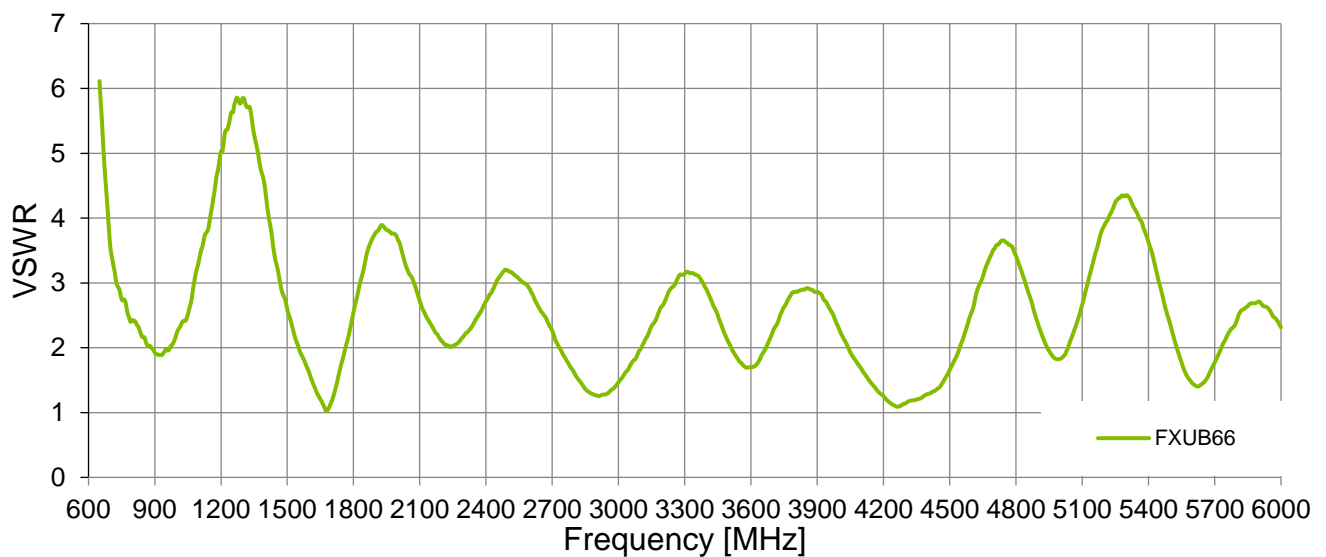

### 3.3 Efficiency

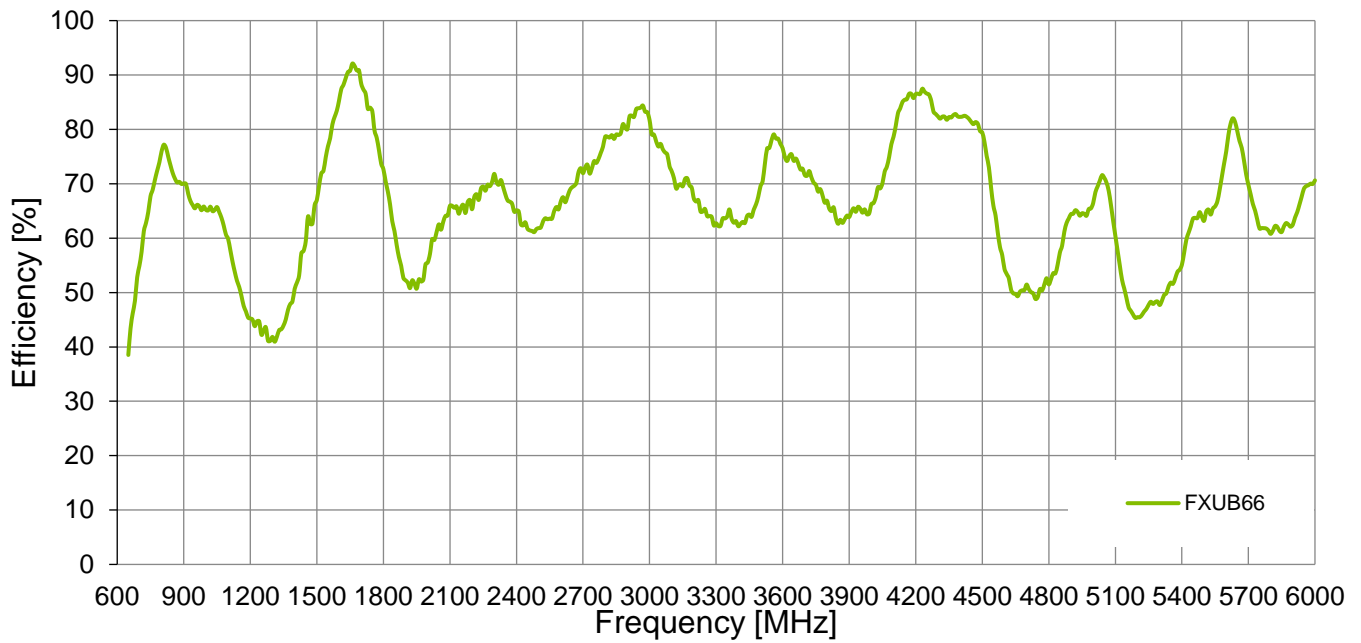

### 3.4 Peak Gain

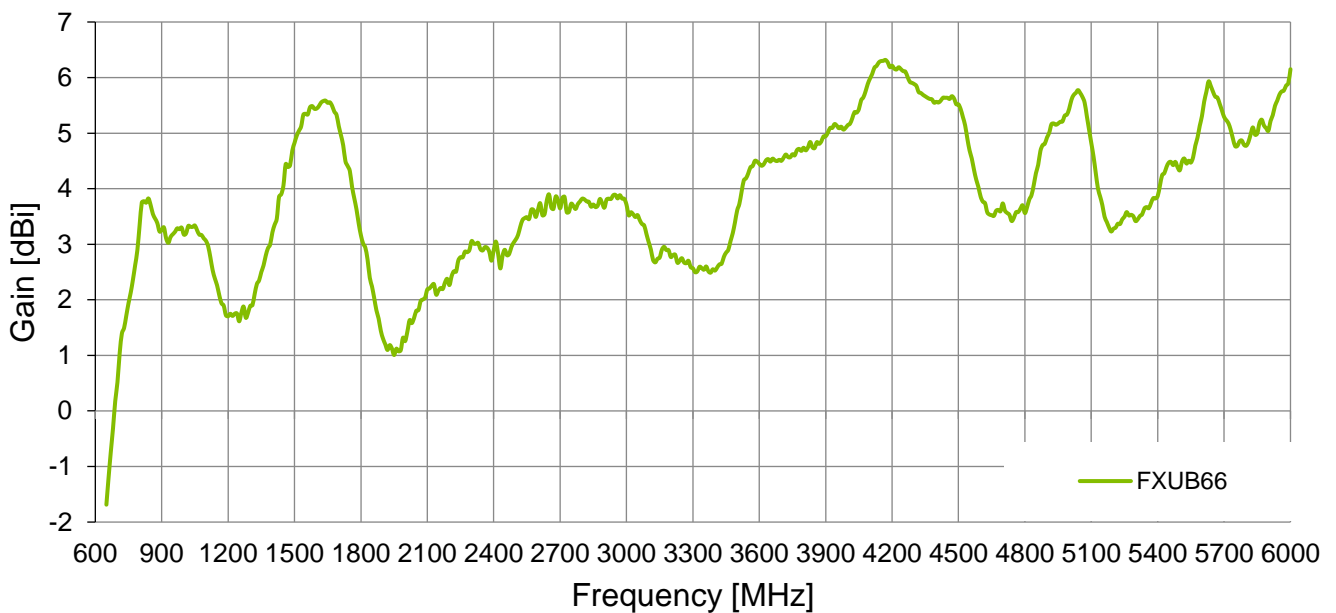

### 3.5 Average Gain

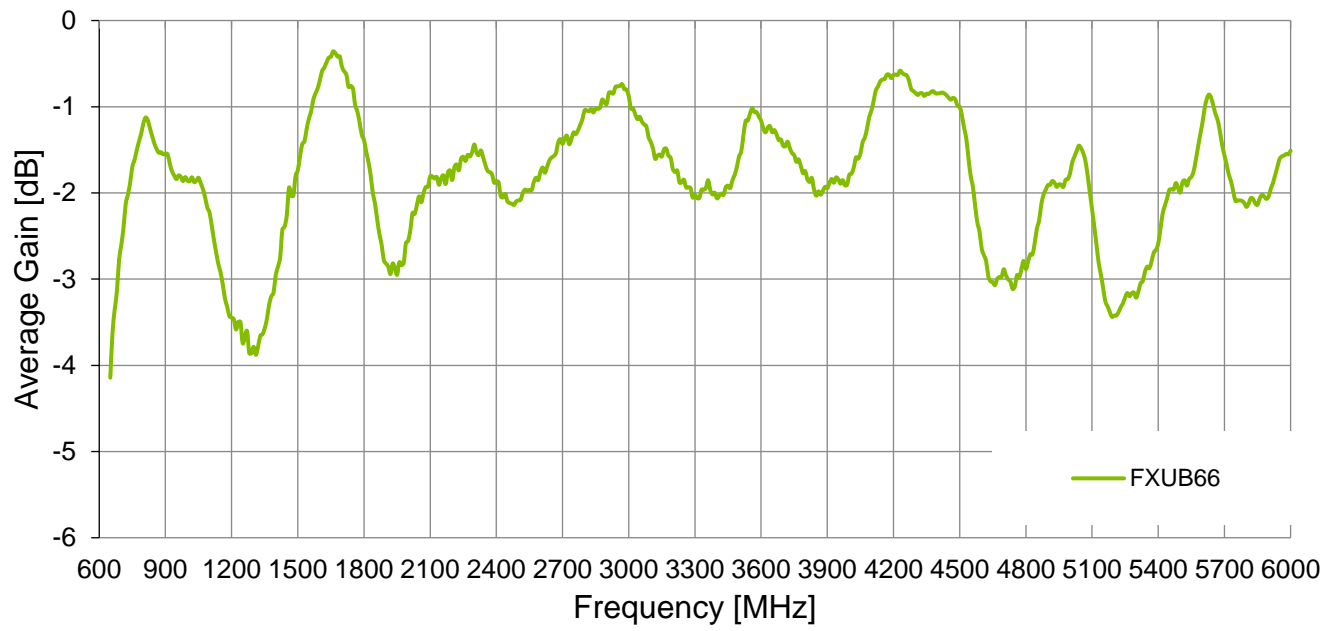



## 4. 2D Radiation Patterns

### 4.1 Test Setup



On 2mm ABS

**XY Plane**

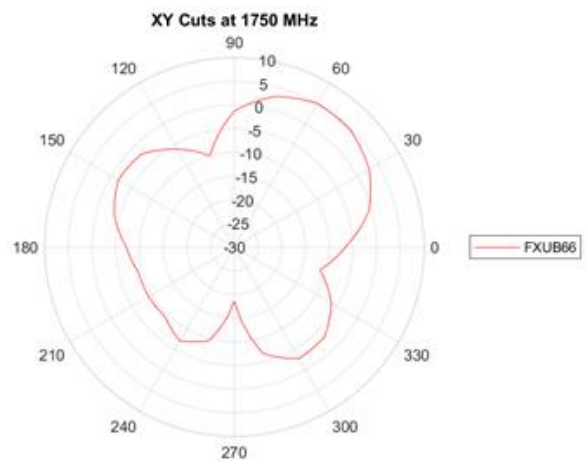
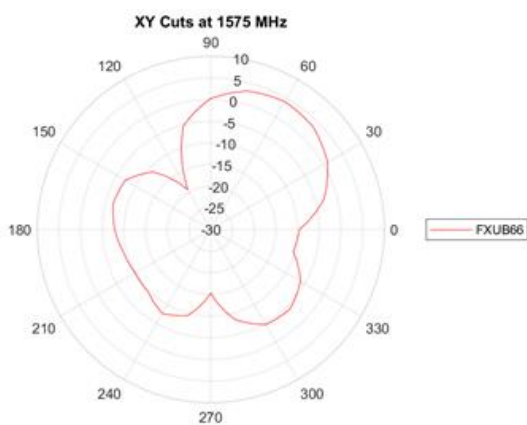
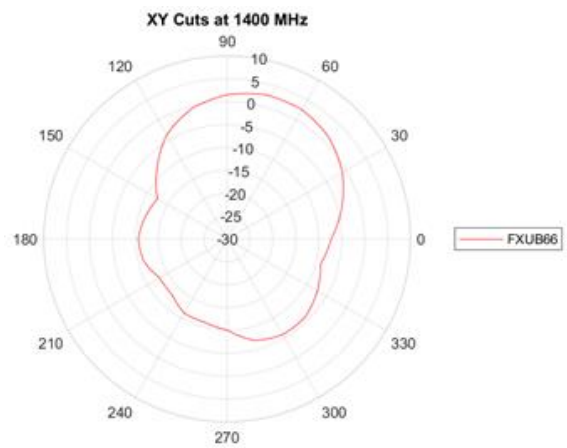
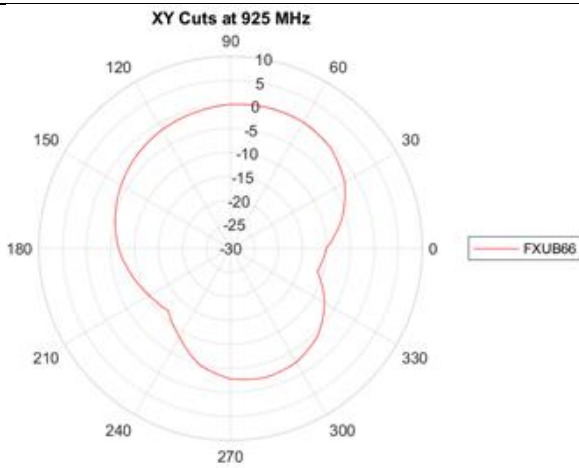
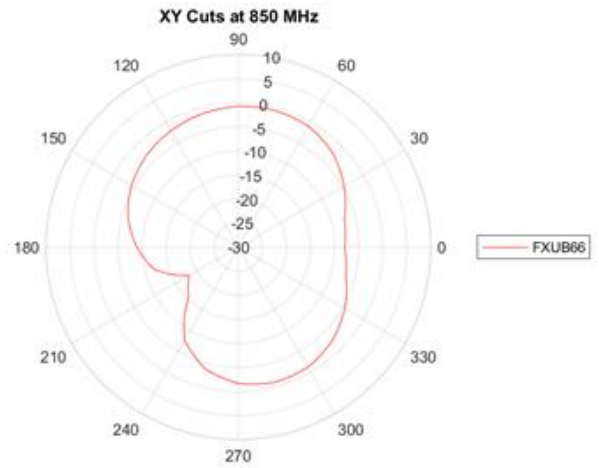
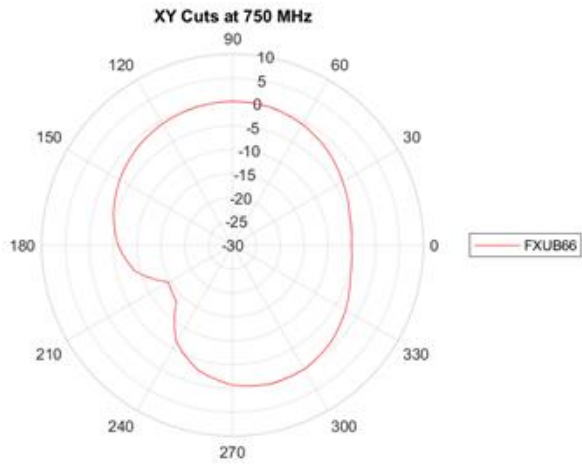

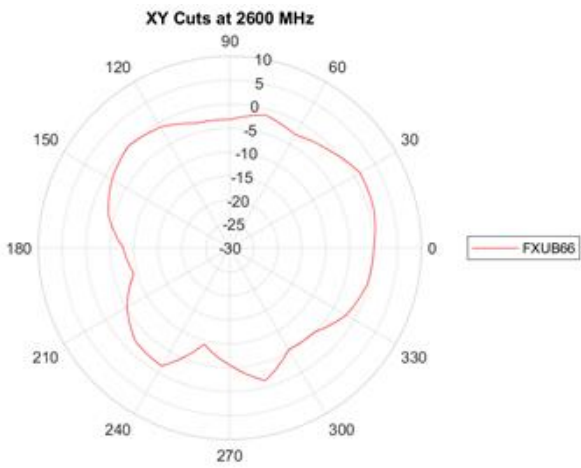
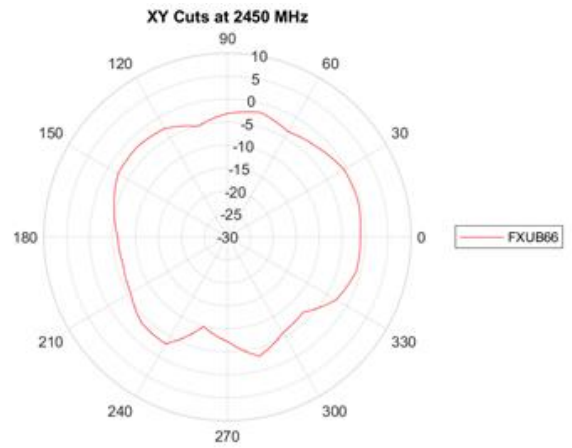
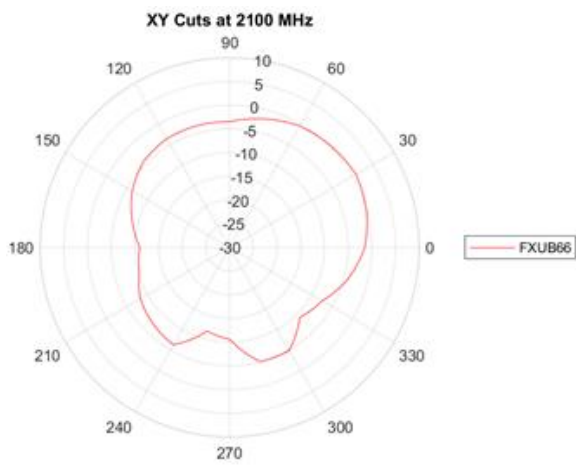
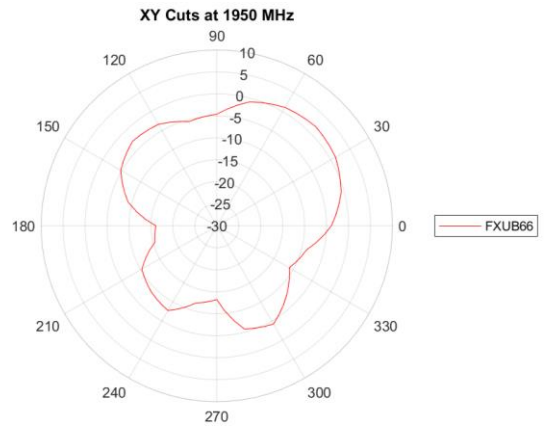
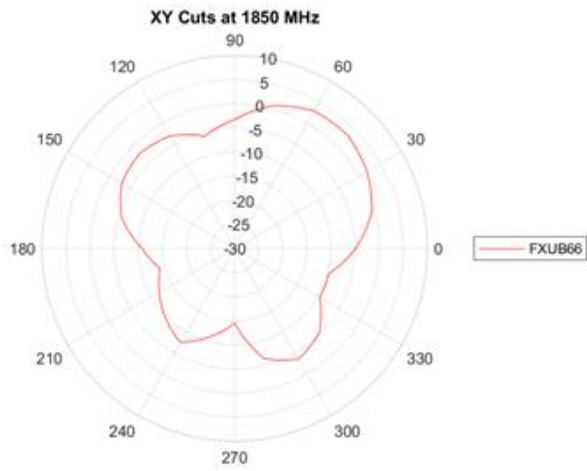



XZ Plane

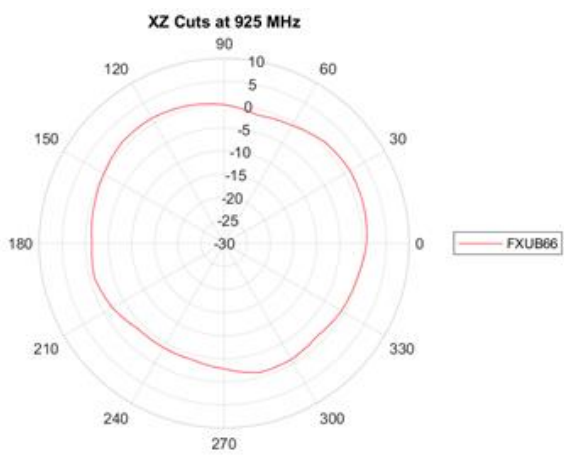
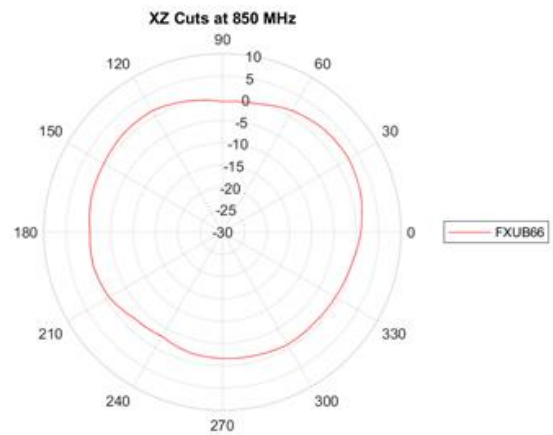
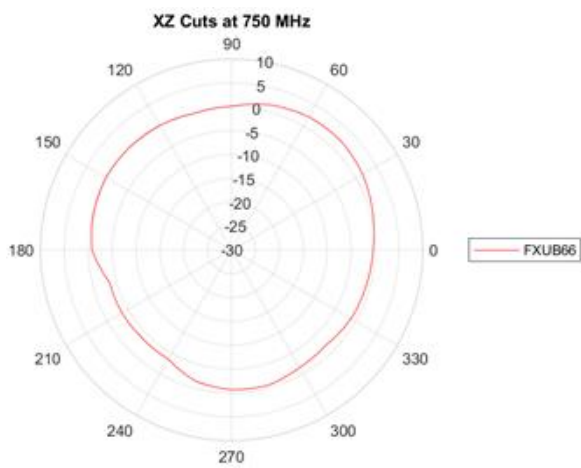

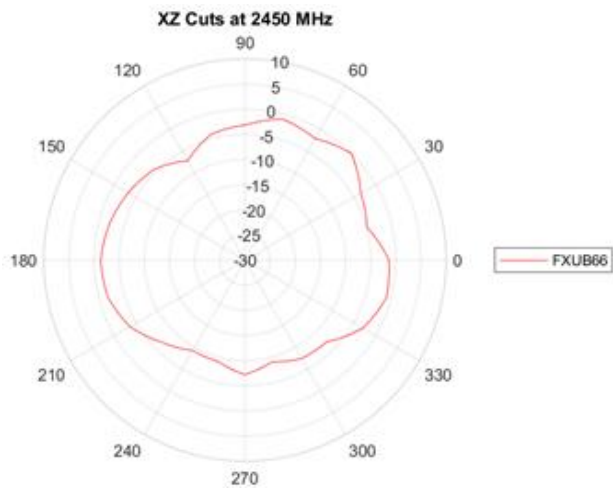
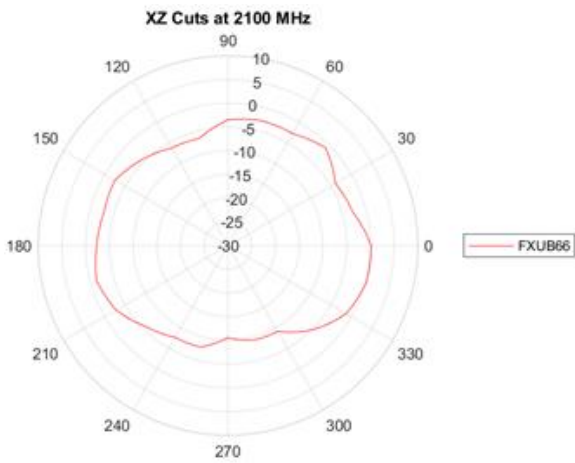
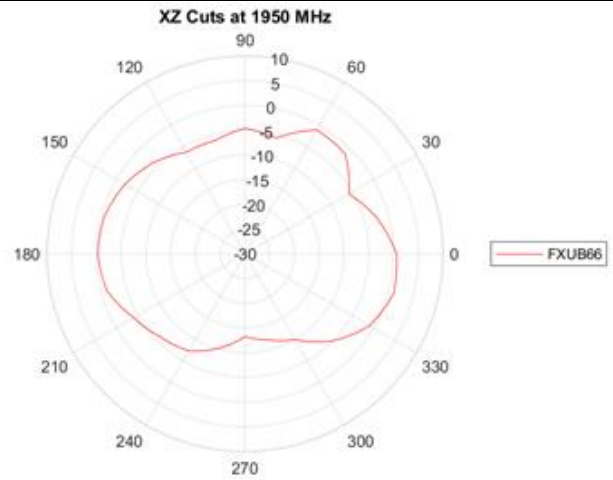
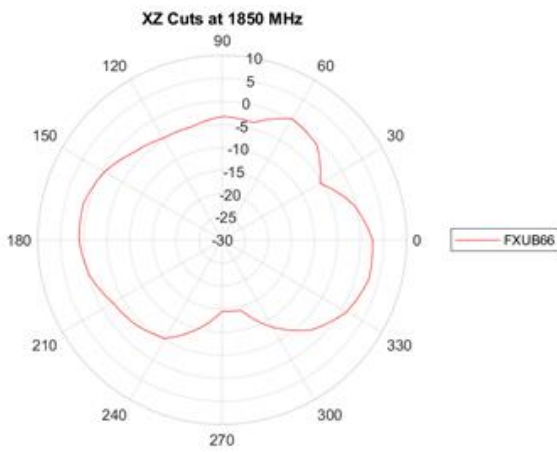
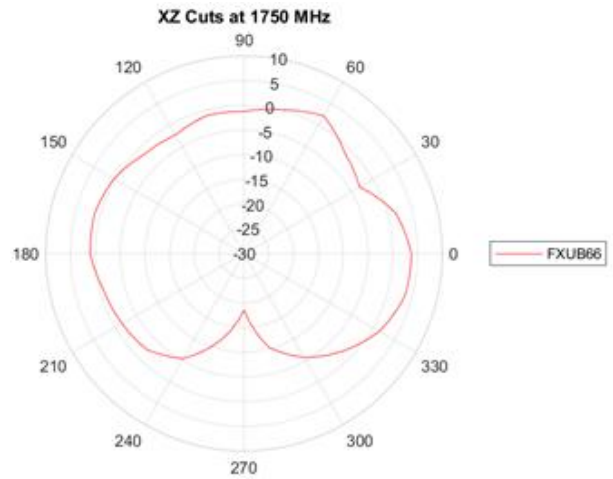
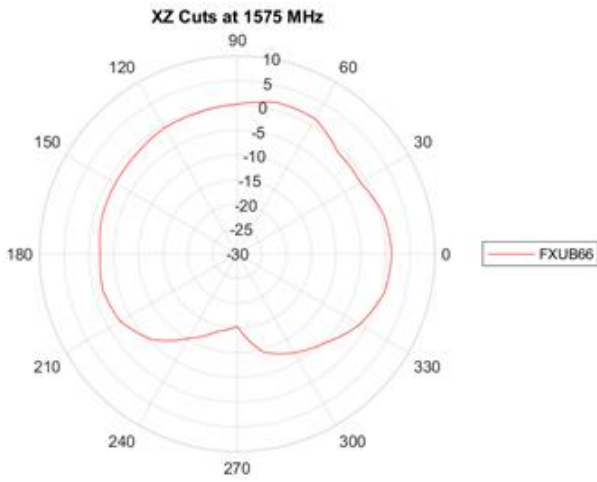

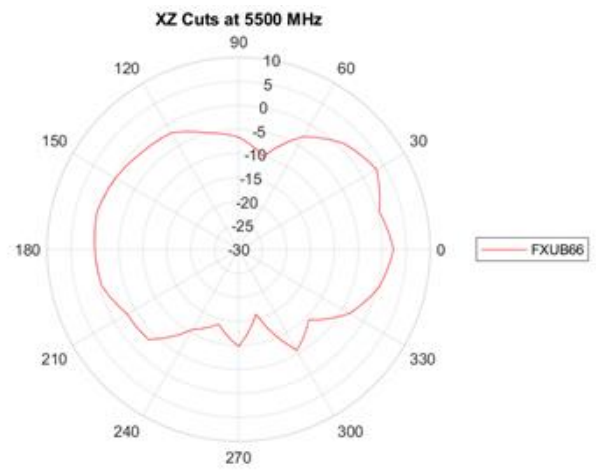
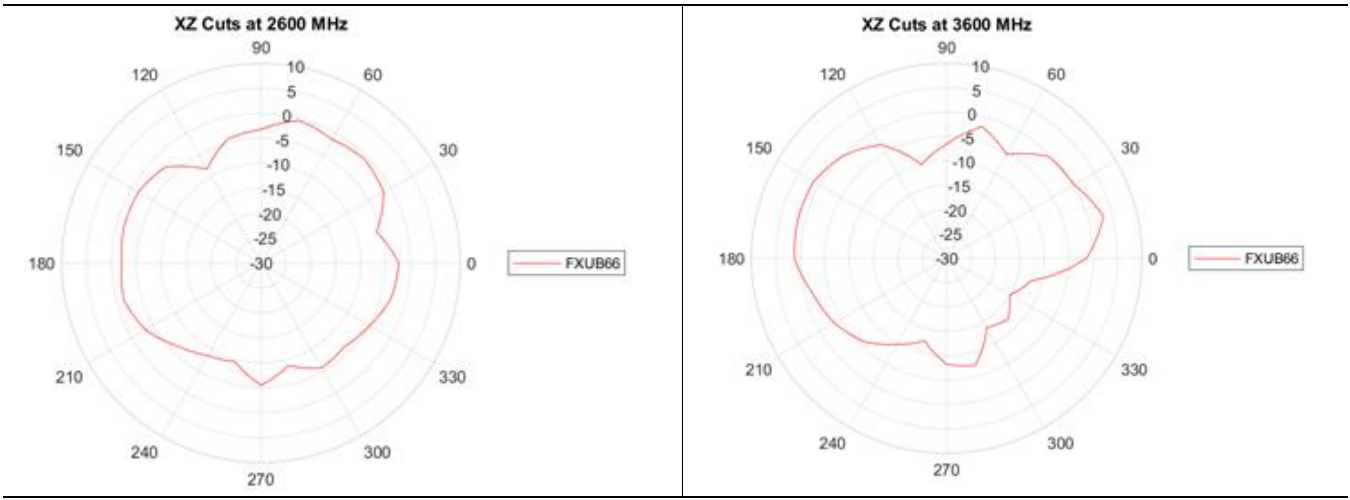

YZ Plane

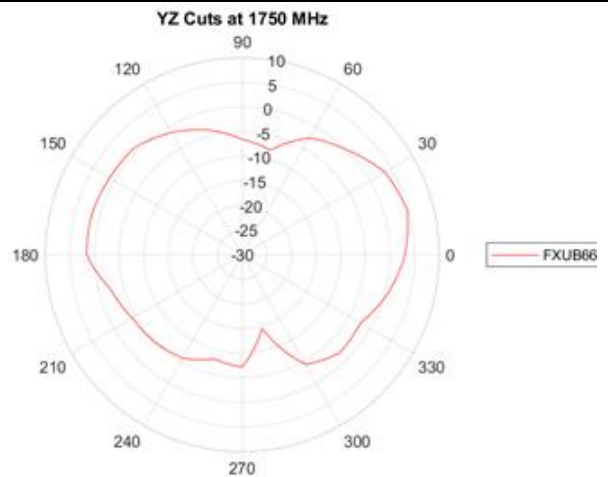
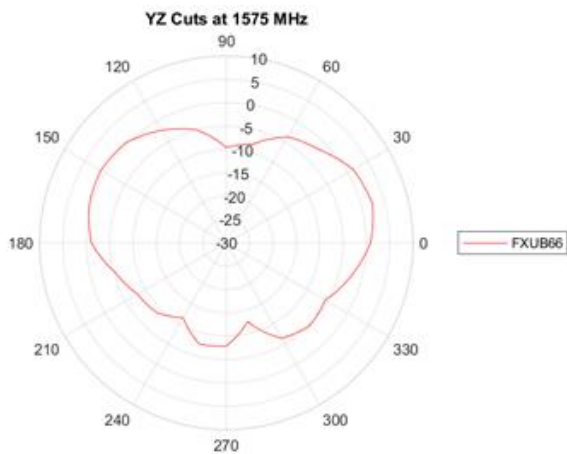
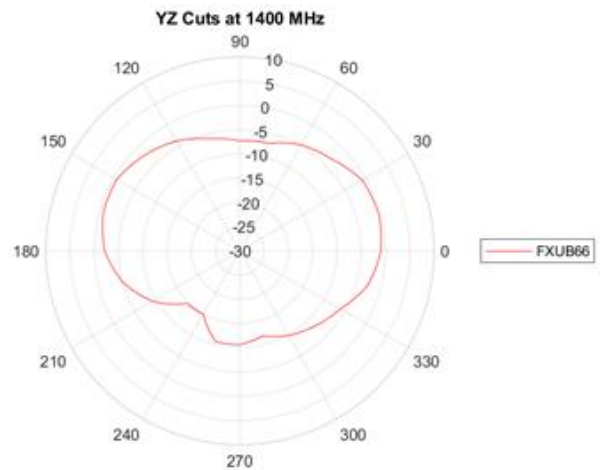
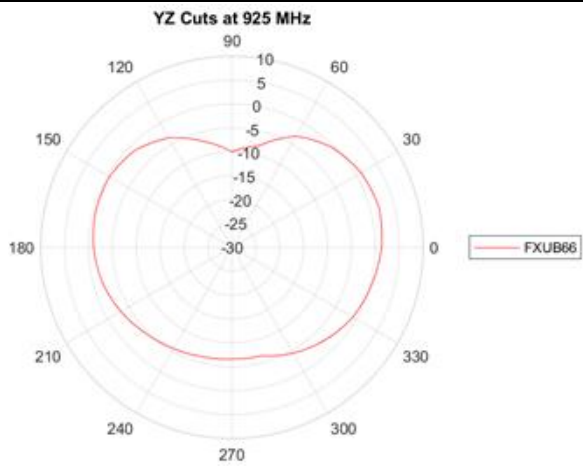
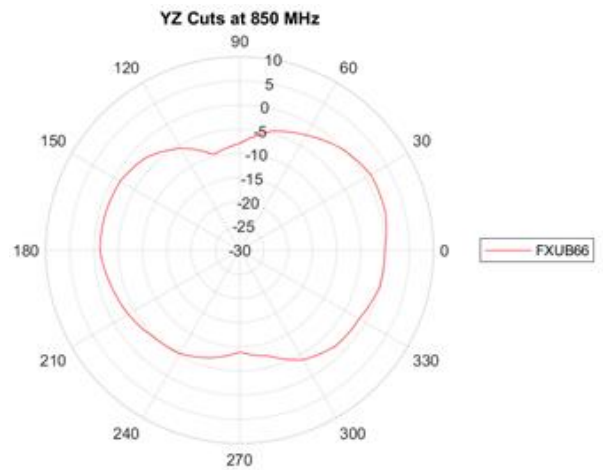
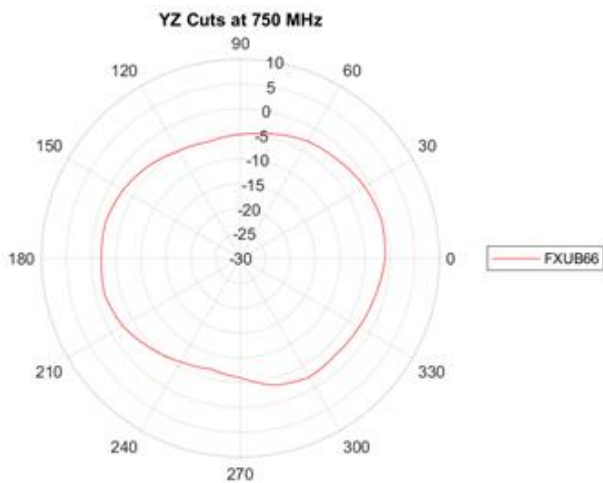

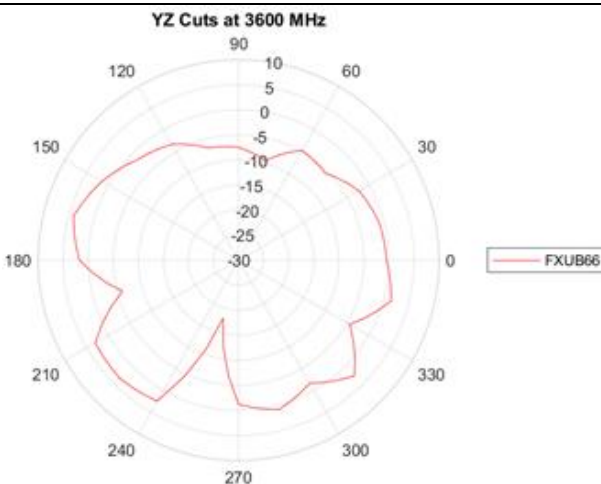
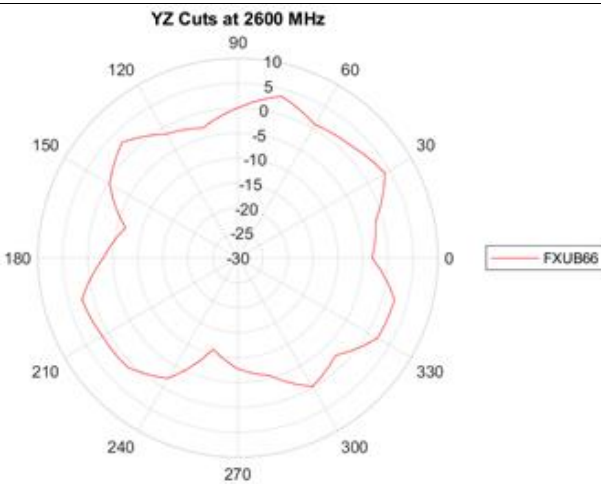
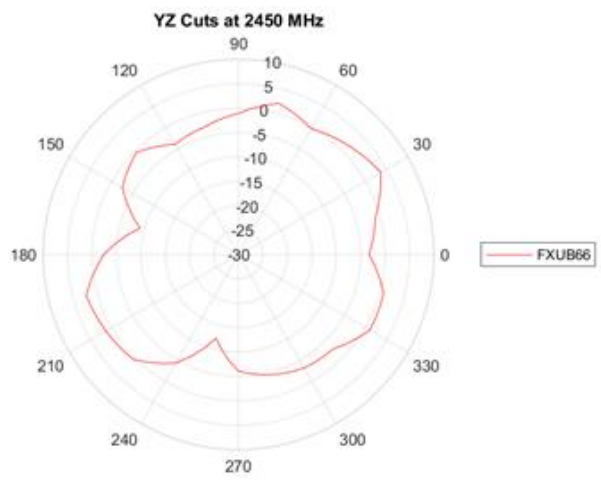
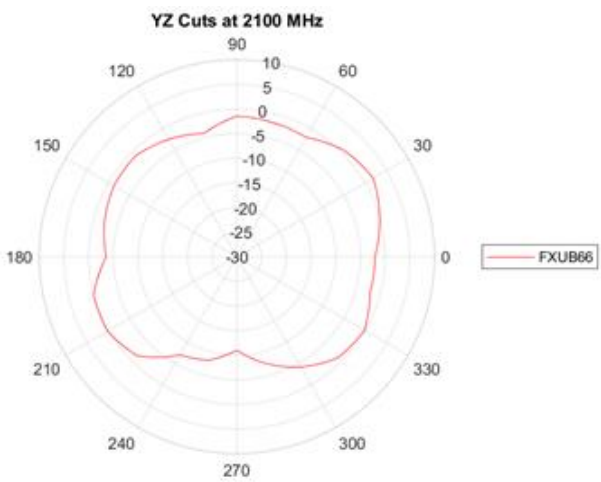
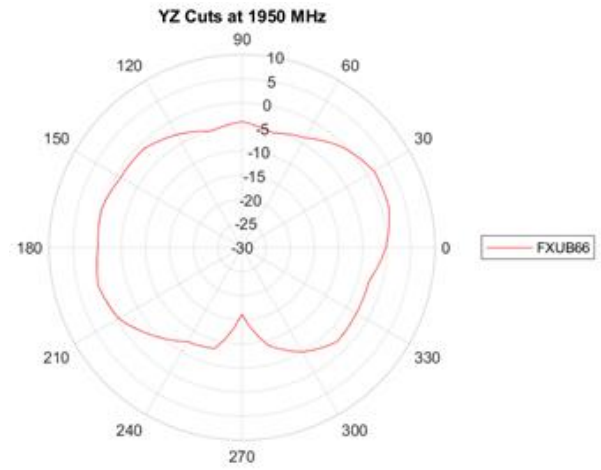
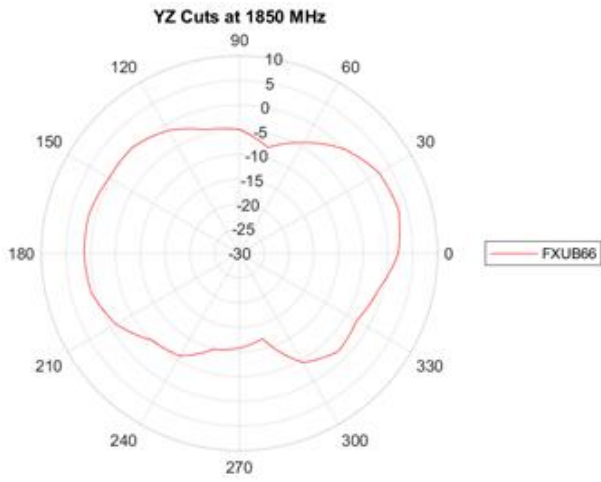



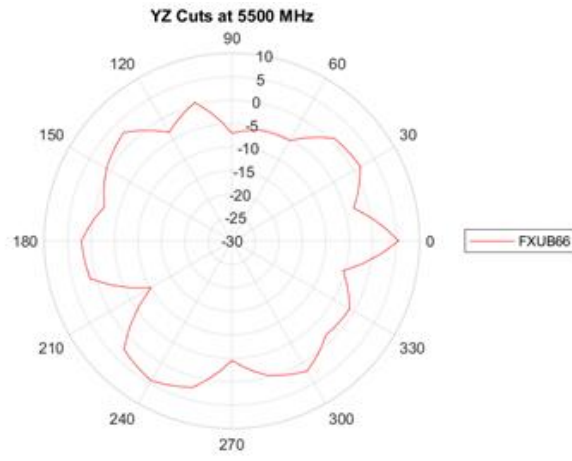

# 5. Mechanical Drawing (Units: mm)

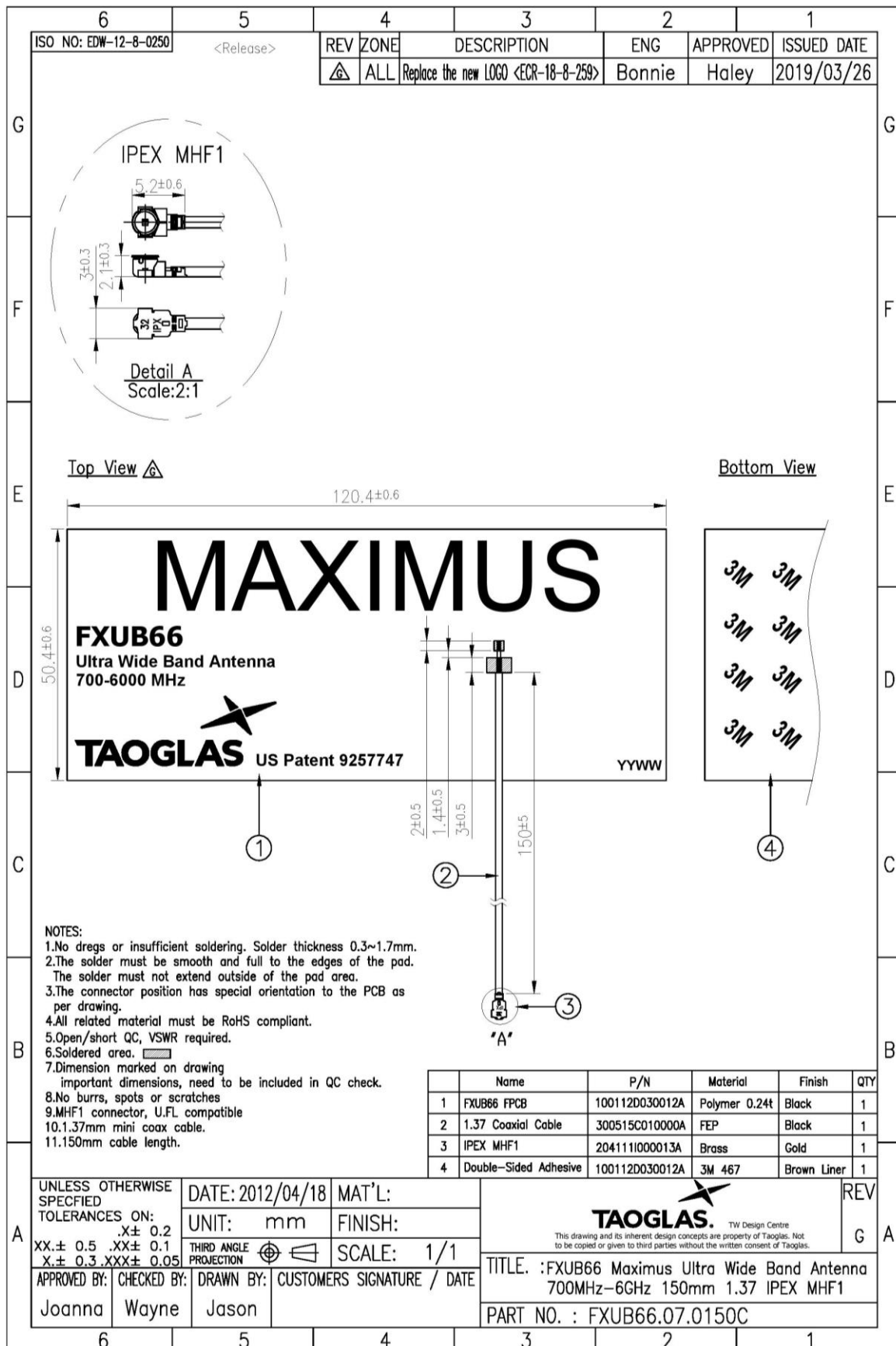

## 6. Packaging

100pcs FXUB66.07.0150C per PE Bag  
 Bag Dimensions - 320 x 200mm  
 Weight - 380g

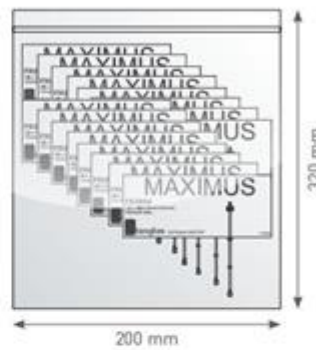
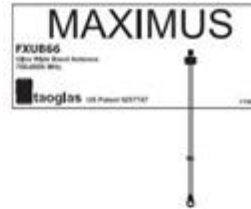

1,000 pcs FXUB66.07.0150C per carton  
 Carton - 370 x 320 x 180mm  
 Weight - 4.01Kg

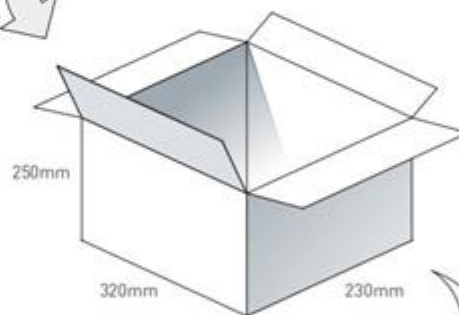

Pallet Dimensions 1200 x 1000 x 1460mm  
 63 Cartons per Pallet  
 9 Cartons per layer  
 7 Layers

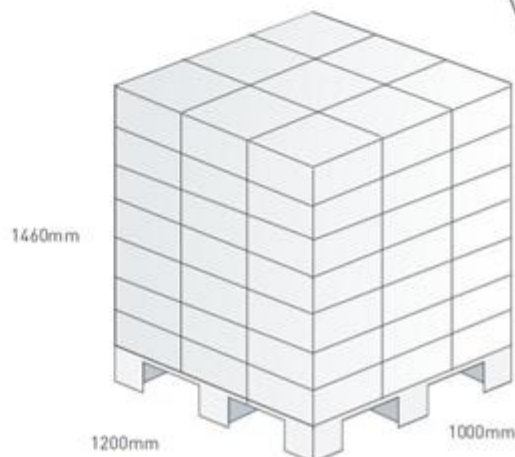

Changelog for the datasheet

**SPE-12-8-040 – FXUB66.07.0150C**

**Revision: I (Current Version)**

Date:	2019-03-26
Changes:	New data added
Changes Made by:	Jack Conroy

**Previous Revisions**

**Revision: H**

Date:	2019-03-26
Changes:	Data and Template Amended
Changes Made by:	Jack Conroy

**Revision: C**

Date:	2012-09-20
Changes:	Packaging Details Updated
Changes Made by:	Aine Doyle

**Revision: G**

Date:	2016-06-10
Changes:	Patent No. Added
Changes Made by:	Aine Doyle

**Revision: B**

Date:	2012-09-10
Changes:	Packaging Details Updated
Changes Made by:	Aine Doyle

**Revision: F**

Date:	2014-02-12
Changes:	Drawing and photo amended
Changes Made by:	Aine Doyle

**Revision: A (Original First Release)**

Date:	2012-04-24
Notes:	
Author:	Aine Doyle

**Revision: E**

Date:	2012-10-02
Changes:	Packaging Details Updated
Changes Made by:	Aine Doyle

**Revision: D**

Date:	2012-09-27
Changes:	Packaging Details Updated
Changes Made by:	Aine Doyle



**TAOGLAS®**

[www.taoglas.com](http://www.taoglas.com)

