

## Dual D Flip-Flop with Set and Reset Positive-Edge Trigger

### Features

- **Hysteresis on Clock Inputs for Improved Noise Immunity and Increased Input Rise and Fall Times**
- **Asynchronous Set and Reset**
- **Complementary Outputs**
- **Buffered Inputs**
- **Typical  $f_{MAX} = 50\text{MHz}$  at  $V_{CC} = 5\text{V}$ ,  $C_L = 15\text{pF}$ ,  $T_A = 25^\circ\text{C}$**
- **Fanout (Over Temperature Range)**
  - Standard Outputs . . . . . 10 LSTTL Loads
  - Bus Driver Outputs . . . . . 15 LSTTL Loads
- **Wide Operating Temperature Range . . .  $-55^\circ\text{C}$  to  $125^\circ\text{C}$**
- **Balanced Propagation Delay and Transition Times**
- **Significant Power Reduction Compared to LSTTL Logic ICs**
- **HC Types**
  - 2V to 6V Operation
  - High Noise Immunity:  $N_{IL} = 30\%$ ,  $N_{IH} = 30\%$  of  $V_{CC}$  at  $V_{CC} = 5\text{V}$
- **HCT Types**
  - 4.5V to 5.5V Operation
  - Direct LSTTL Input Logic Compatibility,  $V_{IL} = 0.8\text{V (Max)}$ ,  $V_{IH} = 2\text{V (Min)}$
  - CMOS Input Compatibility,  $I_I \leq 1\mu\text{A}$  at  $V_{OL}$ ,  $V_{OH}$

### Description

The 'HC74 and 'HCT74 utilize silicon gate CMOS technology to achieve operating speeds equivalent to LSTTL parts. They exhibit the low power consumption of standard CMOS integrated circuits, together with the ability to drive 10 LSTTL loads.

This flip-flop has independent DATA,  $\overline{\text{SET}}$ ,  $\overline{\text{RESET}}$  and CLOCK inputs and Q and  $\overline{\text{Q}}$  outputs. The logic level present at the data input is transferred to the output during the positive-going transition of the clock pulse. SET and RESET are independent of the clock and are accomplished by a low level at the appropriate input.

The HCT logic family is functionally as well as pin compatible with the standard LS logic family.

### Ordering Information

| PART NUMBER  | TEMP. RANGE (°C) | PACKAGE      |
|--------------|------------------|--------------|
| CD54HC74F3A  | -55 to 125       | 14 Ld CERDIP |
| CD54HCT74F3A | -55 to 125       | 14 Ld CERDIP |
| CD74HC74E    | -55 to 125       | 14 Ld PDIP   |
| CD74HC74M    | -55 to 125       | 14 Ld SOIC   |
| CD74HC74MT   | -55 to 125       | 14 Ld SOIC   |
| CD74HC74M96  | -55 to 125       | 14 Ld SOIC   |
| CD74HCT74E   | -55 to 125       | 14 Ld PDIP   |
| CD74HCT74M   | -55 to 125       | 14 Ld SOIC   |
| CD74HCT74MT  | -55 to 125       | 14 Ld SOIC   |
| CD74HCT74M96 | -55 to 125       | 14 Ld SOIC   |

NOTE: When ordering, use the entire part number. The suffix 96 denotes tape and reel. The suffix T denotes a small-quantity reel of 250.

# CD54HC74, CD74HC74, CD54HCT74, CD74HCT74

## Pinout

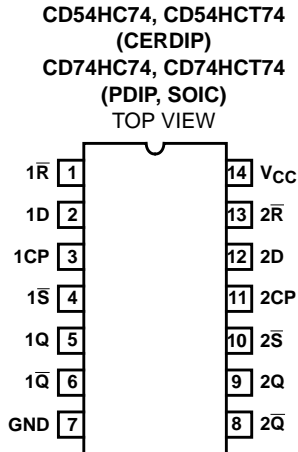

## Functional Diagram

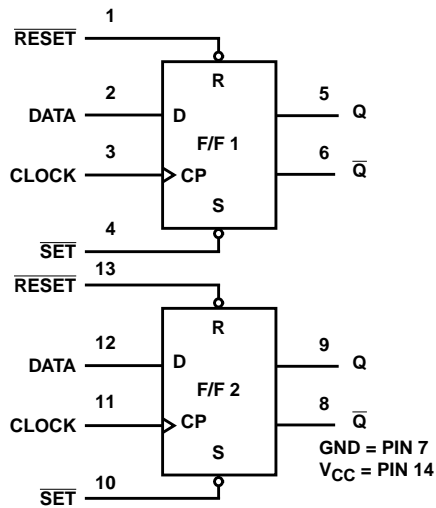

TRUTH TABLE

| INPUTS |       |    |   | OUTPUTS        |                 |
|--------|-------|----|---|----------------|-----------------|
| SET    | RESET | CP | D | Q              | Q̄              |
| L      | H     | X  | X | H              | L               |
| H      | L     | X  | X | L              | H               |
| L      | L     | X  | X | H (Note 1)     | H (Note 1)      |
| H      | H     | ↑  | H | H              | L               |
| H      | H     | ↑  | L | L              | H               |
| H      | H     | L  | X | Q <sub>0</sub> | Q̄ <sub>0</sub> |

H= High Level (Steady State)

L= Low Level (Steady State)

X= Don't Care

↑= Low-to-High Transition

Q<sub>0</sub> = the level of Q before the indicated input conditions were established.

NOTE:

1. This configuration is nonstable, that is, it will not persist when set and reset inputs return to their inactive (high) level.

# CD54HC74, CD74HC74, CD54HCT74, CD74HCT74

## Absolute Maximum Ratings

|  |             |
|--|-------------|
| DC Supply Voltage, $V_{CC}$ .....                      | -0.5V to 7V |
| DC Input Diode Current, $I_{IK}$                       |             |
| For $V_I < -0.5V$ or $V_I > V_{CC} + 0.5V$ .....       | $\pm 20mA$  |
| DC Drain Current, per Output, $I_O$                    |             |
| For $-0.5V < V_O < V_{CC} + 0.5V$ .....                | $\pm 25mA$  |
| DC Output Diode Current, $I_{OK}$                      |             |
| For $V_O < -0.5V$ or $V_O > V_{CC} + 0.5V$ .....       | $\pm 20mA$  |
| DC Output Source or Sink Current per Output Pin, $I_O$ |             |
| For $V_O > -0.5V$ or $V_O < V_{CC} + 0.5V$ .....       | $\pm 25mA$  |
| DC $V_{CC}$ or Ground Current, $I_{CC}$ .....          | $\pm 50mA$  |

## Thermal Information

|  |                                    |
|--|------------------------------------|
| Thermal Resistance (Typical, Note 2)                         | $\theta_{JA}$ ( $^{\circ}C/W$ )    |
| E (PDIP) Package .....                                       | 80                                 |
| M (SOIC) Package .....                                       | 86                                 |
| Maximum Junction Temperature (Hermetic Package or Die) . . . | 175 $^{\circ}C$                    |
| Maximum Junction Temperature (Plastic Package) .....         | 150 $^{\circ}C$                    |
| Maximum Storage Temperature Range .....                      | -65 $^{\circ}C$ to 150 $^{\circ}C$ |
| Maximum Lead Temperature (Soldering 10s) .....               | 300 $^{\circ}C$                    |
| (SOIC - Lead Tips Only)                                      |                                    |

## Operating Conditions

|  |                                    |
|--|------------------------------------|
| Temperature Range ( $T_A$ ) .....            | -55 $^{\circ}C$ to 125 $^{\circ}C$ |
| Supply Voltage Range, $V_{CC}$               |                                    |
| HC Types .....                               | .2V to 6V                          |
| HCT Types .....                              | 4.5V to 5.5V                       |
| DC Input or Output Voltage, $V_I, V_O$ ..... | 0V to $V_{CC}$                     |
| Input Rise and Fall Time                     |                                    |
| 2V .....                                     | 1000ns (Max)                       |
| 4.5V .....                                   | 500ns (Max)                        |
| 6V .....                                     | 400ns (Max)                        |

**CAUTION:** Stresses above those listed in "Absolute Maximum Ratings" may cause permanent damage to the device. This is a stress only rating and operation of the device at these or any other conditions above those indicated in the operational sections of this specification is not implied.

### NOTE:

- The package thermal impedance is calculated in accordance with JESD 51-7.

## DC Electrical Specifications

| PARAMETER                               | SYMBOL   | TEST CONDITIONS         |            | $V_{CC}$ (V) | 25 $^{\circ}C$ |      |           | -40 $^{\circ}C$ TO 85 $^{\circ}C$ |         | -55 $^{\circ}C$ TO 125 $^{\circ}C$ |         | UNITS   |   |
|---|----------|-------------------------|------------|--------------|----------------|------|-----------|-----------------------------------|---------|------------------------------------|---------|---------|---|
|   |          | $V_I$ (V)               | $I_O$ (mA) |              | MIN            | TYP  | MAX       | MIN                               | MAX     | MIN                                | MAX     |         |   |
| <b>HC TYPES</b>                         |          |                         |            |              |                |      |           |                                   |         |                                    |         |         |   |
| High Level Input Voltage                | $V_{IH}$ | -                       | -          | 2            | 1.5            | -    | -         | 1.5                               | -       | 1.5                                | -       | V       |   |
|   |          |                         |            | 4.5          | 3.15           | -    | -         | 3.15                              | -       | 3.15                               | -       | V       |   |
|   |          |                         |            | 6            | 4.2            | -    | -         | 4.2                               | -       | 4.2                                | -       | V       |   |
| Low Level Input Voltage                 | $V_{IL}$ | -                       | -          | 2            | -              | -    | 0.5       | -                                 | 0.5     | -                                  | 0.5     | V       |   |
|   |          |                         |            | 4.5          | -              | -    | 1.35      | -                                 | 1.35    | -                                  | 1.35    | V       |   |
|   |          |                         |            | 6            | -              | -    | 1.8       | -                                 | 1.8     | -                                  | 1.8     | V       |   |
| High Level Output Voltage<br>CMOS Loads | $V_{OH}$ | $V_{IH}$ or<br>$V_{IL}$ | -0.02      | 2            | 1.9            | -    | -         | 1.9                               | -       | 1.9                                | -       | V       |   |
|   |          |                         |            | 4.5          | 4.4            | -    | -         | 4.4                               | -       | 4.4                                | -       | V       |   |
|   |          |                         |            | 6            | 5.9            | -    | -         | 5.9                               | -       | 5.9                                | -       | V       |   |
| High Level Output Voltage<br>TTL Loads  | $V_{OH}$ | $V_{IH}$ or<br>$V_{IL}$ | -          | -            | -              | -    | -         | -                                 | -       | -                                  | -       | V       |   |
|   |          |                         |            | -4           | 4.5            | 3.98 | -         | -                                 | 3.84    | -                                  | 3.7     | -       | V |
|   |          |                         |            | -5.2         | 6              | 5.48 | -         | -                                 | 5.34    | -                                  | 5.2     | -       | V |
| Low Level Output Voltage<br>CMOS Loads  | $V_{OL}$ | $V_{IH}$ or<br>$V_{IL}$ | 0.02       | 2            | -              | -    | 0.1       | -                                 | 0.1     | -                                  | 0.1     | V       |   |
|   |          |                         |            | 4.5          | -              | -    | 0.1       | -                                 | 0.1     | -                                  | 0.1     | V       |   |
|   |          |                         |            | 6            | -              | -    | 0.1       | -                                 | 0.1     | -                                  | 0.1     | V       |   |
| Low Level Output Voltage<br>TTL Loads   | $V_{OL}$ | $V_{IH}$ or<br>$V_{IL}$ | -          | -            | -              | -    | -         | -                                 | -       | -                                  | -       | V       |   |
|   |          |                         |            | 4            | 4.5            | -    | -         | 0.26                              | -       | 0.33                               | -       | 0.4     | V |
|   |          |                         |            | 5.2          | 6              | -    | -         | 0.26                              | -       | 0.33                               | -       | 0.4     | V |
| Input Leakage Current                   | $I_I$    | $V_{CC}$ or<br>GND      | -          | 6            | -              | -    | $\pm 0.1$ | -                                 | $\pm 1$ | -                                  | $\pm 1$ | $\mu A$ |   |

**CD54HC74, CD74HC74, CD54HCT74, CD74HCT74**

**DC Electrical Specifications (Continued)**

| PARAMETER  | SYMBOL                    | TEST CONDITIONS                    |                     | V <sub>CC</sub> (V) | 25°C |     |      | -40°C TO 85°C |      | -55°C TO 125°C |     | UNITS |
|--|---------------------------|------------------------------------|---------------------|---------------------|------|-----|------|---------------|------|----------------|-----|-------|
|  |                           | V <sub>I</sub> (V)                 | I <sub>O</sub> (mA) |                     | MIN  | TYP | MAX  | MIN           | MAX  | MIN            | MAX |       |
| Quiescent Device Current                                       | I <sub>CC</sub>           | V <sub>CC</sub> or GND             | 0                   | 6                   | -    | -   | 4    | -             | 40   | -              | 80  | μA    |
| <b>HCT TYPES</b>   |                           |                                    |                     |                     |      |     |      |               |      |                |     |       |
| High Level Input Voltage                                       | V <sub>IH</sub>           | -                                  | -                   | 4.5 to 5.5          | 2    | -   | -    | 2             | -    | 2              | -   | V     |
| Low Level Input Voltage  | V <sub>IL</sub>           | -                                  | -                   | 4.5 to 5.5          | -    | -   | 0.8  | -             | 0.8  | -              | 0.8 | V     |
| High Level Output Voltage<br>CMOS Loads                        | V <sub>OH</sub>           | V <sub>IH</sub> or V <sub>IL</sub> | -0.02               | 4.5                 | 4.4  | -   | -    | 4.4           | -    | 4.4            | -   | V     |
| High Level Output Voltage<br>TTL Loads                         |                           |                                    | -4                  | 4.5                 | 3.98 | -   | -    | 3.84          | -    | 3.7            | -   | V     |
| Low Level Output Voltage<br>CMOS Loads                         | V <sub>OL</sub>           | V <sub>IH</sub> or V <sub>IL</sub> | 0.02                | 4.5                 | -    | -   | 0.1  | -             | 0.1  | -              | 0.1 | V     |
| Low Level Output Voltage<br>TTL Loads                          |                           |                                    | 4                   | 4.5                 | -    | -   | 0.26 | -             | 0.33 | -              | 0.4 | V     |
| Input Leakage Current  | I <sub>I</sub>            | V <sub>CC</sub> and GND            | -                   | 5.5                 | -    |     | ±0.1 | -             | ±1   | -              | ±1  | μA    |
| Quiescent Device Current                                       | I <sub>CC</sub>           | V <sub>CC</sub> or GND             | 0                   | 5.5                 | -    | -   | 4    | -             | 40   | -              | 80  | μA    |
| Additional Quiescent Device Current Per Input Pin: 1 Unit Load | ΔI <sub>CC</sub> (Note 3) | V <sub>CC</sub> - 2.1              | -                   | 4.5 to 5.5          | -    | 100 | 360  | -             | 450  | -              | 490 | μA    |

NOTE:

3. For dual-supply systems theoretical worst case (V<sub>I</sub> = 2.4V, V<sub>CC</sub> = 5.5V) specification is 1.8mA.

**HCT Input Loading Table**

| INPUT     | UNIT LOADS |
|-----------|------------|
| D         | 0.5        |
| $\bar{R}$ | 0.5        |
| CP        | 0.7        |
| $\bar{S}$ | 0.75       |

NOTE: Unit Load is ΔI<sub>CC</sub> limit specified in DC Electrical Specifications table, e.g., 360μA max at 25°C.

**Prerequisite For Switching Specifications**

| PARAMETER                        | SYMBOL          | TEST CONDITIONS | V <sub>CC</sub> (V) | 25°C |     |     | -40°C TO 85°C |     | -55°C TO 125°C |     | UNITS |
|----------------------------------|-----------------|-----------------|---------------------|------|-----|-----|---------------|-----|----------------|-----|-------|
|                                  |                 |                 |                     | MIN  | TYP | MAX | MIN           | MAX | MIN            | MAX |       |
| <b>HC TYPES</b>                  |                 |                 |                     |      |     |     |               |     |                |     |       |
| Data to CP Setup Time (Figure 5) | t <sub>SU</sub> | -               | 2                   | 60   | -   | -   | 75            | -   | 90             | -   | ns    |
|                                  |                 |                 | 4.5                 | 12   | -   | -   | 15            | -   | 18             | -   | ns    |
|                                  |                 |                 | 6                   | 10   | -   | -   | 13            | -   | 15             | -   | ns    |

**CD54HC74, CD74HC74, CD54HCT74, CD74HCT74**

**Prerequisite For Switching Specifications (Continued)**

| PARAMETER   | SYMBOL           | TEST CONDITIONS | V <sub>CC</sub> (V) | 25°C |     |     | -40°C TO 85°C |     | -55°C TO 125°C |     | UNITS |
|---|------------------|-----------------|---------------------|------|-----|-----|---------------|-----|----------------|-----|-------|
|   |                  |                 |                     | MIN  | TYP | MAX | MIN           | MAX | MIN            | MAX |       |
| Hold Time (Figure 5)                                  | t <sub>H</sub>   | -               | 2                   | 3    | -   | -   | 3             | -   | 3              | -   | ns    |
|   |                  |                 | 4.5                 | 3    | -   | -   | 3             | -   | 3              | -   | ns    |
|   |                  |                 | 6                   | 3    | -   | -   | 3             | -   | 3              | -   | ns    |
| Removal Time $\bar{R}$ , $\bar{S}$ , to CP (Figure 5) | t <sub>REM</sub> | -               | 2                   | 30   | -   | -   | 40            | -   | 45             | -   | ns    |
|   |                  |                 | 4.5                 | 6    | -   | -   | 8             | -   | 9              | -   | ns    |
|   |                  |                 | 6                   | 5    | -   | -   | 7             | -   | 8              | -   | ns    |
| Pulse Width $\bar{R}$ , $\bar{S}$ (Figure 1)          | t <sub>W</sub>   | -               | 2                   | 80   | -   | -   | 100           | -   | 120            | -   | ns    |
|   |                  |                 | 4.5                 | 16   | -   | -   | 20            | -   | 24             | -   | ns    |
|   |                  |                 | 6                   | 14   | -   | -   | 17            | -   | 20             | -   | ns    |
| Pulse Width CP (Figure 1)                             | t <sub>W</sub>   | -               | 2                   | 80   | -   | -   | 100           | -   | 120            | -   | ns    |
|   |                  |                 | 4.5                 | 16   | -   | -   | 20            | -   | 24             | -   | ns    |
|   |                  |                 | 6                   | 14   | -   | -   | 17            | -   | 20             | -   | ns    |
| CP Frequency  | f <sub>MAX</sub> | -               | 2                   | 6    | -   | -   | 5             | -   | 4              | -   | MHz   |
|   |                  |                 | 4.5                 | 30   | -   | -   | 25            | -   | 20             | -   | MHz   |
|   |                  |                 | 6                   | 35   | -   | -   | 29            | -   | 23             | -   | MHz   |

**HCT TYPES**

|   |                  |   |     |    |   |   |    |   |    |   |     |
|---|------------------|---|-----|----|---|---|----|---|----|---|-----|
| Data to CP Setup Time (Figure 6)                      | t <sub>SU</sub>  | - | 4.5 | 12 | - | - | 15 | - | 18 | - | ns  |
| Hold Time (Figure 6)                                  | t <sub>H</sub>   | - | 4.5 | 3  | - | - | 3  | - | 3  | - | ns  |
| Removal Time $\bar{R}$ , $\bar{S}$ , to CP (Figure 6) | t <sub>REM</sub> | - | 4.5 | 6  | - | - | 8  | - | 9  | - | ns  |
| Pulse Width $\bar{R}$ , $\bar{S}$ (Figure 2)          | t <sub>W</sub>   | - | 4.5 | 16 | - | - | 20 | - | 24 | - | ns  |
| Pulse Width CP (Figure 2)                             | t <sub>W</sub>   | - | 4.5 | 18 | - | - | 23 | - | 27 | - | ns  |
| CP Frequency  | f <sub>MAX</sub> | - | 4.5 | 25 | - | - | 20 | - | 16 | - | MHz |

**Switching Specifications** Input t<sub>p</sub>, t<sub>f</sub> = 6ns

| PARAMETER   | SYMBOL                              | TEST CONDITIONS       | V <sub>CC</sub> (V) | 25°C |     |     | -40°C TO 85°C |     | -55°C TO 125°C |     | UNITS |
|---|-------------------------------------|-----------------------|---------------------|------|-----|-----|---------------|-----|----------------|-----|-------|
|   |                                     |                       |                     | MIN  | TYP | MAX | MIN           | MAX | MIN            | MAX |       |
| <b>HC TYPES</b>   |                                     |                       |                     |      |     |     |               |     |                |     |       |
| Propagation Delay, CP to Q, $\bar{Q}$ (Figure 3)                    | t <sub>PLH</sub> , t <sub>PHL</sub> | C <sub>L</sub> = 50pF | 2                   | -    | -   | 175 | -             | 220 | -              | 265 | ns    |
|   |                                     | C <sub>L</sub> = 50pF | 4.5                 | -    | -   | 35  | -             | 44  | -              | 53  | ns    |
|   |                                     | C <sub>L</sub> = 15pF | 5                   | -    | 14  | -   | -             | -   | -              | -   | ns    |
|   |                                     | C <sub>L</sub> = 50pF | 6                   | -    | -   | 30  | -             | 37  | -              | 45  | ns    |
| Propagation Delay, $\bar{R}$ , $\bar{S}$ to Q, $\bar{Q}$ (Figure 3) | t <sub>PLH</sub> , t <sub>PHL</sub> | C <sub>L</sub> = 50pF | 2                   | -    | -   | 200 | -             | 250 | -              | 300 | ns    |
|   |                                     | C <sub>L</sub> = 50pF | 4.5                 | -    | -   | 40  | -             | 50  | -              | 60  | ns    |
|   |                                     | C <sub>L</sub> = 15pF | 5                   | -    | 17  | -   | -             | -   | -              | -   | ns    |
|   |                                     | C <sub>L</sub> = 50pF | 6                   | -    | -   | 34  | -             | 43  | -              | 51  | ns    |
| Transition Time (Figure 3)  | t <sub>TLH</sub> , t <sub>THL</sub> | C <sub>L</sub> = 50pF | 2                   | -    | -   | 75  | -             | 95  | -              | 110 | ns    |
|   |                                     | C <sub>L</sub> = 50pF | 4.5                 | -    | -   | 15  | -             | 19  | -              | 22  | ns    |
|   |                                     | C <sub>L</sub> = 50pF | 6                   | -    | -   | 13  | -             | 16  | -              | 19  | ns    |
| Input Capacitance   | C <sub>I</sub>                      | -                     | -                   | -    | -   | 10  | -             | 10  | -              | 10  | pF    |

## CD54HC74, CD74HC74, CD54HCT74, CD74HCT74

### Switching Specifications Input $t_r, t_f = 6\text{ns}$ (Continued)

| PARAMETER  | SYMBOL             | TEST CONDITIONS     | $V_{CC}$ (V) | 25°C |     |     | -40°C TO 85°C |     | -55°C TO 125°C |     | UNITS |
|--|--------------------|---------------------|--------------|------|-----|-----|---------------|-----|----------------|-----|-------|
|  |                    |                     |              | MIN  | TYP | MAX | MIN           | MAX | MIN            | MAX |       |
| CP Frequency                                     | $f_{MAX}$          | $C_L = 15\text{pF}$ | 5            | -    | 50  | -   | -             | -   | -              | -   | MHz   |
| Power Dissipation Capacitance (Notes 4, 5)       | $C_{PD}$           | -                   | 5            | -    | 25  | -   | -             | -   | -              | -   | pF    |
| <b>HCT TYPES</b>                                 |                    |                     |              |      |     |     |               |     |                |     |       |
| Propagation Delay, CP to Q, $\bar{Q}$ (Figure 4) | $t_{PLH}, t_{PHL}$ | $C_L = 50\text{pF}$ | 4.5          | -    | -   | 35  | -             | 44  | -              | 53  | ns    |
| Propagation Delay, R, S to Q, Q (Figure 4)       | $t_{PHL}, t_{PLH}$ | $C_L = 50\text{pF}$ | 4.5          | -    | -   | 40  | -             | 50  | -              | 60  | ns    |
| Transition Time (Figure 4)                       | $t_{TLH}, t_{THL}$ | $C_L = 50\text{pF}$ | 4.5          | -    | -   | 15  | -             | 19  | -              | 22  | ns    |
| Input Capacitance                                | $C_I$              | -                   | -            | -    | -   | 10  | -             | 10  | -              | 10  | pF    |
| CP Frequency                                     | $f_{MAX}$          | $C_L = 15\text{pF}$ | 5            | -    | 50  | -   | -             | -   | -              | -   | MHz   |
| Power Dissipation Capacitance (Notes 4, 5)       | $C_{PD}$           | -                   | 5            | -    | 30  | -   | -             | -   | -              | -   | pF    |

**NOTES:**

- $C_{PD}$  is used to determine the dynamic power consumption, per flip-flop.
- $P_D = C_{PD} V_{CC}^2 f_i + \sum (C_L V_{CC}^2 f_o)$  where  $f_i$  = input frequency,  $f_o$  = output frequency,  $C_L$  = output load capacitance,  $V_{CC}$  = supply voltage.

### Test Circuits and Waveforms

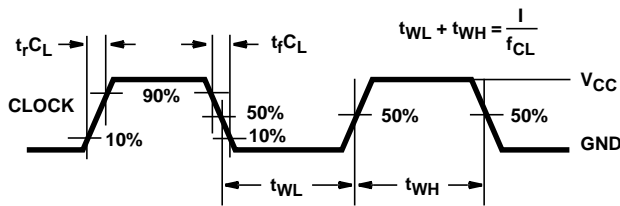

NOTE: Outputs should be switching from 10%  $V_{CC}$  to 90%  $V_{CC}$  in accordance with device truth table. For  $f_{MAX}$ , input duty cycle = 50%.

**FIGURE 1. HC CLOCK PULSE RISE AND FALL TIMES AND PULSE WIDTH**

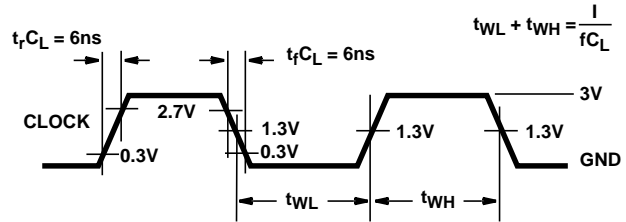

NOTE: Outputs should be switching from 10%  $V_{CC}$  to 90%  $V_{CC}$  in accordance with device truth table. For  $f_{MAX}$ , input duty cycle = 50%.

**FIGURE 2. HCT CLOCK PULSE RISE AND FALL TIMES AND PULSE WIDTH**

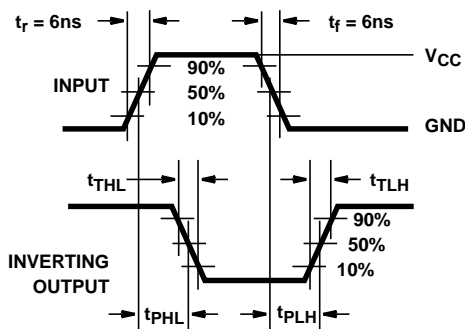

**FIGURE 3. HC AND HCU TRANSITION TIMES AND PROPAGATION DELAY TIMES, COMBINATION LOGIC**

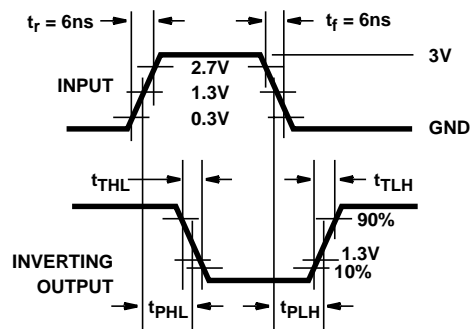

**FIGURE 4. HCT TRANSITION TIMES AND PROPAGATION DELAY TIMES, COMBINATION LOGIC**

Test Circuits and Waveforms (Continued)



FIGURE 5. HC SETUP TIMES, HOLD TIMES, REMOVAL TIME, AND PROPAGATION DELAY TIMES FOR EDGE TRIGGERED SEQUENTIAL LOGIC CIRCUITS



FIGURE 6. HCT SETUP TIMES, HOLD TIMES, REMOVAL TIME, AND PROPAGATION DELAY TIMES FOR EDGE TRIGGERED SEQUENTIAL LOGIC CIRCUITS

J (R-GDIP-T\*\*)

14 LEADS SHOWN

CERAMIC DUAL IN-LINE PACKAGE



| DIM \ PINS ** | 14                     | 16                     | 18                     | 20                     |
|---------------|------------------------|------------------------|------------------------|------------------------|
| A             | 0.300<br>(7,62)<br>BSC | 0.300<br>(7,62)<br>BSC | 0.300<br>(7,62)<br>BSC | 0.300<br>(7,62)<br>BSC |
| B MAX         | 0.785<br>(19,94)       | .840<br>(21,34)        | 0.960<br>(24,38)       | 1.060<br>(26,92)       |
| B MIN         | —                      | —                      | —                      | —                      |
| C MAX         | 0.300<br>(7,62)        | 0.300<br>(7,62)        | 0.310<br>(7,87)        | 0.300<br>(7,62)        |
| C MIN         | 0.245<br>(6,22)        | 0.245<br>(6,22)        | 0.220<br>(5,59)        | 0.245<br>(6,22)        |



4040083/F 03/03

- NOTES:
- All linear dimensions are in inches (millimeters).
  - This drawing is subject to change without notice.
  - This package is hermetically sealed with a ceramic lid using glass frit.
  - Index point is provided on cap for terminal identification only on press ceramic glass frit seal only.
  - Falls within MIL STD 1835 GDIP1-T14, GDIP1-T16, GDIP1-T18 and GDIP1-T20.



N (R-PDIP-T\*\*)

PLASTIC DUAL-IN-LINE PACKAGE

16 PINS SHOWN

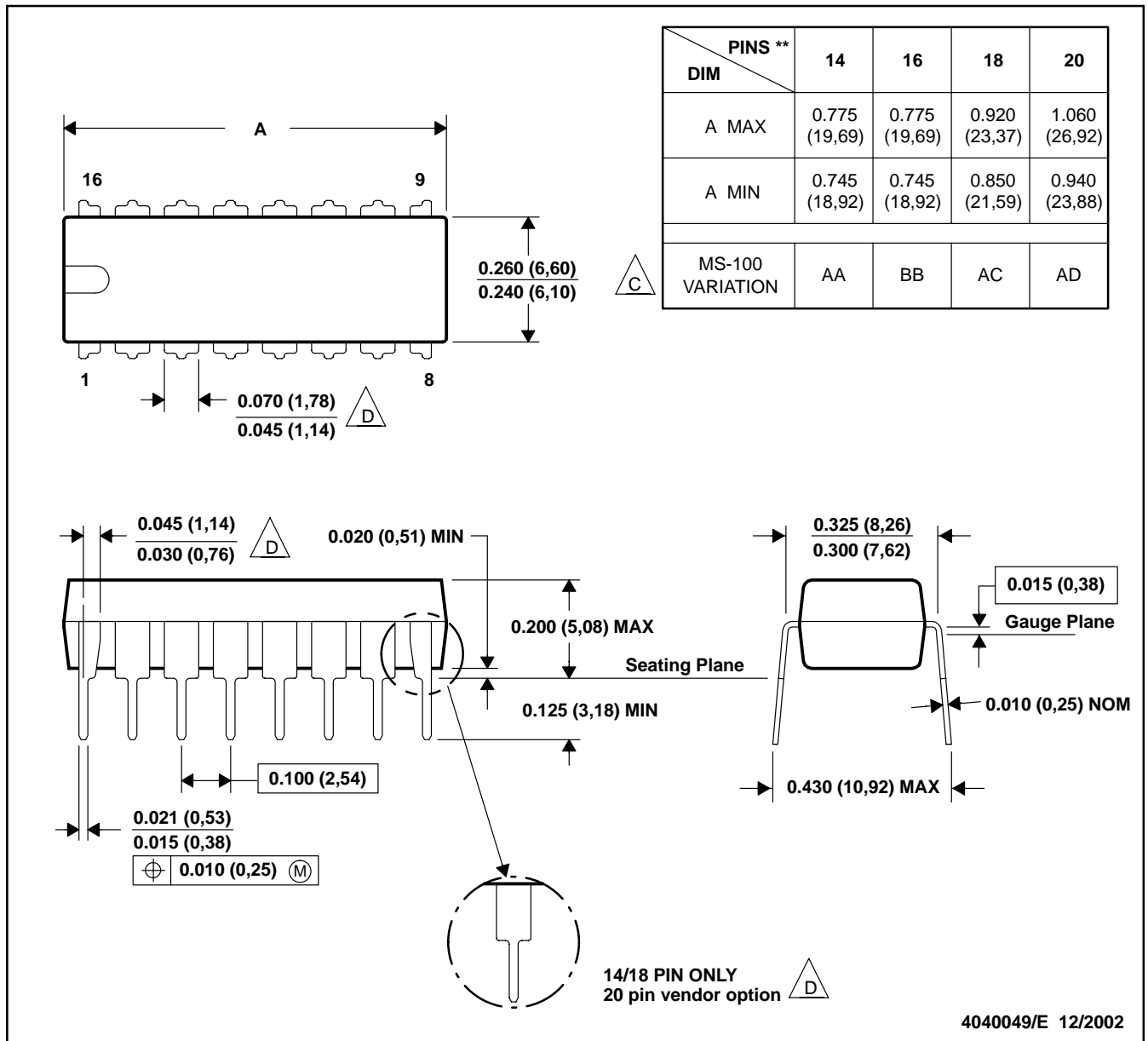

- NOTES: A. All linear dimensions are in inches (millimeters).  
 B. This drawing is subject to change without notice.  
 C Falls within JEDEC MS-001, except 18 and 20 pin minimum body length (Dim A).  
 D The 20 pin end lead shoulder width is a vendor option, either half or full width.

D (R-PDSO-G\*\*)

PLASTIC SMALL-OUTLINE PACKAGE

8 PINS SHOWN



- NOTES: A. All linear dimensions are in inches (millimeters).  
 B. This drawing is subject to change without notice.  
 C. Body dimensions do not include mold flash or protrusion, not to exceed 0.006 (0,15).  
 D. Falls within JEDEC MS-012

## IMPORTANT NOTICE

Texas Instruments Incorporated and its subsidiaries (TI) reserve the right to make corrections, modifications, enhancements, improvements, and other changes to its products and services at any time and to discontinue any product or service without notice. Customers should obtain the latest relevant information before placing orders and should verify that such information is current and complete. All products are sold subject to TI's terms and conditions of sale supplied at the time of order acknowledgment.

TI warrants performance of its hardware products to the specifications applicable at the time of sale in accordance with TI's standard warranty. Testing and other quality control techniques are used to the extent TI deems necessary to support this warranty. Except where mandated by government requirements, testing of all parameters of each product is not necessarily performed.

TI assumes no liability for applications assistance or customer product design. Customers are responsible for their products and applications using TI components. To minimize the risks associated with customer products and applications, customers should provide adequate design and operating safeguards.

TI does not warrant or represent that any license, either express or implied, is granted under any TI patent right, copyright, mask work right, or other TI intellectual property right relating to any combination, machine, or process in which TI products or services are used. Information published by TI regarding third-party products or services does not constitute a license from TI to use such products or services or a warranty or endorsement thereof. Use of such information may require a license from a third party under the patents or other intellectual property of the third party, or a license from TI under the patents or other intellectual property of TI.

Reproduction of information in TI data books or data sheets is permissible only if reproduction is without alteration and is accompanied by all associated warranties, conditions, limitations, and notices. Reproduction of this information with alteration is an unfair and deceptive business practice. TI is not responsible or liable for such altered documentation.

Resale of TI products or services with statements different from or beyond the parameters stated by TI for that product or service voids all express and any implied warranties for the associated TI product or service and is an unfair and deceptive business practice. TI is not responsible or liable for any such statements.

Following are URLs where you can obtain information on other Texas Instruments products and application solutions:

| <b>Products</b>  |  | <b>Applications</b> |  |
|------------------|--|---------------------|--|
| Amplifiers       | <a href="http://amplifier.ti.com">amplifier.ti.com</a>             | Audio               | <a href="http://www.ti.com/audio">www.ti.com/audio</a>                   |
| Data Converters  | <a href="http://dataconverter.ti.com">dataconverter.ti.com</a>     | Automotive          | <a href="http://www.ti.com/automotive">www.ti.com/automotive</a>         |
| DSP              | <a href="http://dsp.ti.com">dsp.ti.com</a>                         | Broadband           | <a href="http://www.ti.com/broadband">www.ti.com/broadband</a>           |
| Interface        | <a href="http://interface.ti.com">interface.ti.com</a>             | Digital Control     | <a href="http://www.ti.com/digitalcontrol">www.ti.com/digitalcontrol</a> |
| Logic            | <a href="http://logic.ti.com">logic.ti.com</a>                     | Military            | <a href="http://www.ti.com/military">www.ti.com/military</a>             |
| Power Mgmt       | <a href="http://power.ti.com">power.ti.com</a>                     | Optical Networking  | <a href="http://www.ti.com/opticalnetwork">www.ti.com/opticalnetwork</a> |
| Microcontrollers | <a href="http://microcontroller.ti.com">microcontroller.ti.com</a> | Security            | <a href="http://www.ti.com/security">www.ti.com/security</a>             |
|                  |  | Telephony           | <a href="http://www.ti.com/telephony">www.ti.com/telephony</a>           |
|                  |  | Video & Imaging     | <a href="http://www.ti.com/video">www.ti.com/video</a>                   |
|                  |  | Wireless            | <a href="http://www.ti.com/wireless">www.ti.com/wireless</a>             |

Mailing Address: Texas Instruments  
Post Office Box 655303 Dallas, Texas 75265

Copyright © 2003, Texas Instruments Incorporated