

LMH6723,LMH6724,LMH6725

*LMH6723/LMH6724/LMH6725 Single/Dual/Quad 370 MHz 1 mA Current Feedback
Operational Amplifier*



Literature Number: SNOSA83G

LMH6723/LMH6724/LMH6725

Single/Dual/Quad 370 MHz 1 mA Current Feedback Operational Amplifier

General Description

The LMH6723/LMH6724/LMH6725 provides a 260 MHz small signal bandwidth at a gain of +2 V/V and a 600 V/ μ s slew rate while consuming only 1 mA from \pm 5V supplies.

The LMH6723/LMH6724/LMH6725 supports video applications with its 0.03% and 0.11° differential gain and phase for NTSC and PAL video signals. The LMH6723/LMH6724/LMH6725 also offers a flat gain response of 0.1 dB to 100 MHz. Additionally, the LMH6723/LMH6724/LMH6725 can deliver 110 mA of linear output current. This level of performance, as well as a wide supply range of 4.5 to 12V, makes the LMH6723/LMH6724/LMH6725 an ideal op amp for a variety of portable applications. The LMH6723/LMH6724/LMH6725's small packages (TSSOP, SOIC & SOT23), low power requirement and high performance allow the LMH6723/LMH6724/LMH6725 to serve a wide variety of portable applications.

The LMH6723/LMH6724/LMH6725 is manufactured in National's VIP10™ complimentary bipolar process.

Features

- Large signal bandwidth and slew rate 100% tested
- 370 MHz bandwidth ($A_V = 1$, $V_{OUT} = 0.5 V_{PP}$) -3 dB BW
- 260 MHz ($A_V = +2 V/V$, $V_{OUT} = 0.5 V_{PP}$) -3 dB BW
- 1 mA supply current
- 110 mA linear output current
- 0.03%, 0.11° differential gain, phase
- 0.1 dB gain flatness to 100 MHz
- Fast slew rate: 600 V/ μ s
- Unity gain stable
- Single supply range of 4.5 to 12V
- Improved replacement for CLC450, CLC452, (LMH6723)

Applications

- Line driver
- Portable video
- A/D driver
- Portable DVD

Typical Application

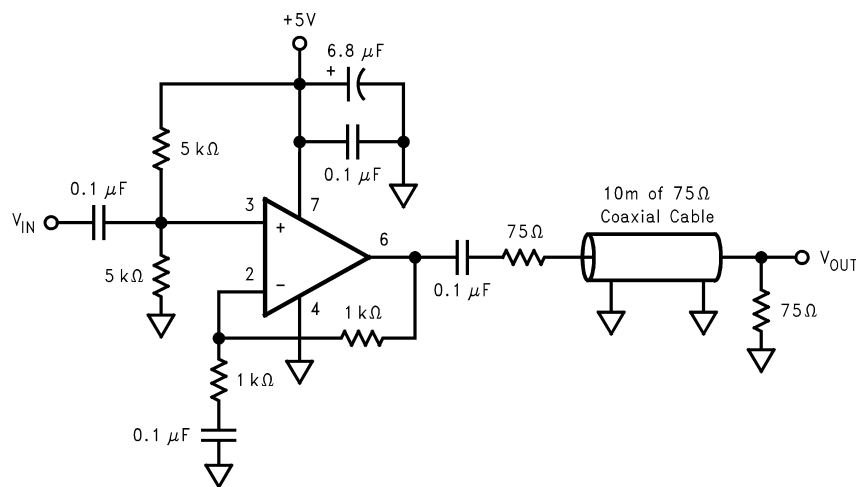

Single Supply Cable Driver

20078936

Absolute Maximum Ratings (Note 1)

If Military/Aerospace specified devices are required, please contact the National Semiconductor Sales Office/Distributors for availability and specifications.

V_{CC} (V^+ - V^-)	$\pm 6.75V$
I_{OUT}	120 mA (Note 3)
Common Mode Input Voltage	$\pm V_{CC}$
Maximum Junction Temperature	+150°C
Storage Temperature Range	-65°C to +150°C
Soldering Information	
Infrared or Convection (20 sec)	235°C
Wave Soldering (10 sec)	260°C
ESD Tolerance (Note 4)	

Human Body Model 2000V

Machine Model (Note 4) 200V

Operating Ratings (Note 3)

Thermal Resistance	
Package	(θ_{JA})
8-Pin SOIC	166°C/W
5-Pin SOT23	230°C/W
14-Pin SOIC	130°C/W
14-Pin TSSOP	160°C/W
Operating Temperature Range	-40°C to +85°C
Nominal Supply Voltage	4.5V to 12V

 $\pm 5V$ Electrical Characteristics

Unless otherwise specified, $A_V = +2$, $R_F = 1200\Omega$, $R_L = 100\Omega$. **Boldface** limits apply at temperature extremes. (Note 2)

Symbol	Parameter	Conditions	Min	Typ	Max	Units
Frequency Domain Response						
SSBW	-3 dB Bandwidth Small Signal	$V_{OUT} = 0.5 V_{PP}$		260		MHz
LSBW	-3dB Bandwidth Large Signal	$V_{OUT} = 4.0 V_{PP}$	LMH6723	90	110	MHz
			LMH6724	85	95	
			LMH6725			
UGBW	-3 dB Bandwidth Unity Gain	$V_{OUT} = .2 V_{PP}$ $A_V = 1 V/V$		370		MHz
.1dB BW	.1 dB Bandwidth	$V_{OUT} = 0.5 V_{PP}$		100		MHz
DG	Differential Gain	$R_L = 150\Omega$, 4.43 MHz		0.03		%
DP	Differential Phase	$R_L = 150\Omega$, 4.43 MHz		0.11		deg
Time Domain Response						
TRS	Rise and Fall Time	4V Step		2.5		ns
TSS	Settling Time to 0.05%	2V Step		30		ns
SR	Slew Rate	4V Step	500	600		V/ μ s
Distortion and Noise Response						
HD2	2 nd Harmonic Distortion	2 V_{PP} , 5 MHz		-65		dBc
HD3	3 rd Harmonic Distortion	2 V_{PP} , 5 MHz		-63		dBc
Equivalent Input Noise						
VN	Non-Inverting Voltage Noise	>1 MHz		4.3		nV/ \sqrt{Hz}
NICN	Inverting Current Noise	>1 MHz		6		pA/ \sqrt{Hz}
ICN	Non-Inverting Current Noise	>1 MHz		6		pA/ \sqrt{Hz}
Static, DC Performance						
V_{IO}	Input Offset Voltage			1	± 3 ± 3.7	mV
I_{BN}	Input Bias Current	Non-Inverting		-2	± 4 ± 5	μ A
I_{BI}	Input Bias Current	Inverting		0.4	± 4 ± 5	μ A
PSRR	Power Supply Rejection Ratio	DC, 1V Step	LMH6723	59 57	64	dB
			LMH6724	59 55	64	
			LMH6725	59 56	64	

±5V Electrical Characteristics (Continued)Unless otherwise specified, $A_V = +2$, $R_F = 1200\Omega$, $R_L = 100\Omega$. **Boldface** limits apply at temperature extremes. (Note 2)

Symbol	Parameter	Conditions	Min	Typ	Max	Units
CMRR	Common Mode Rejection Ratio	DC, 1V Step	LMH6723	57 55	60	dB
			LMH6724	57 53	60	
			LMH6725	57 54	60	
I_{CC}	Supply Current (per amplifier)	$R_L = \infty$		1	1.2 1.4	mA
Miscellaneous Performance						
R_{IN+}	Input Resistance	Non-Inverting		100		k Ω
R_{IN-}	Input Resistance (Output Resistance of Input Buffer)	Inverting		500		Ω
C_{IN}	Input Capacitance	Non-Inverting		1.5		pF
R_{OUT}	Output Resistance	Closed Loop		0.01		Ω
V_O	Output Voltage Range	$R_L = \infty$	LMH6723	± 4 ± 3.9	± 4.1	V
			LMH6724	± 4 ± 3.85	± 4.1	
			LMH6725	± 4 ± 3.85	± 4.1	
V_{OL}	Output Voltage Range, High	$R_L = 100\Omega$	3.6 3.5	3.7		V
	Output Voltage Range, Low	$R_L = 100\Omega$	-3.25 -3.1	-3.45		
CMVR	Input Voltage Range	Common Mode, CMRR > 50 dB	± 4.0			V
I_O	Output Current	Sourcing, $V_{OUT} = 0$	95 70	110		mA
		Sinking, $V_{OUT} = 0$	-80 -70	110		

±2.5V Electrical CharacteristicsUnless otherwise specified, $A_V = +2$, $R_F = 1200\Omega$, $R_L = 100\Omega$. **Boldface** limits apply at temperature extremes. (Note 2)

Symbol	Parameter	Conditions	Min	Typ	Max	Units
Frequency Domain Response						
SSBW	-3 dB Bandwidth Small Signal	$V_{OUT} = 0.5 V_{PP}$		210		MHz
LSBW	-3 dB Bandwidth Large Signal	$V_{OUT} = 2.0 V_{PP}$	LMH6723	95	125	MHz
			LMH6724			
			LMH6725	90	100	
UGBW	-3 dB Bandwidth Unity Gain	$V_{OUT} = 0.5 V_{PP}$, $A_V = 1 V/V$		290		MHz
.1dB BW	.1 dB Bandwidth	$V_{OUT} = 0.5 V_{PP}$		100		MHz
DG	Differential Gain	$R_L = 150\Omega$, 4.43 MHz		.03		%
DP	Differential Phase	$R_L = 150\Omega$, 4.43 MHz		0.1		deg
Time Domain Response						
TRS	Rise and Fall Time	2V Step		4		ns
SR	Slew Rate	2V Step	275	400		V/ μ s
Distortion and Noise Response						
HD2	2 nd Harmonic Distortion	2 V_{PP} , 5 MHz		-67		dBc
HD3	3 rd Harmonic Distortion	2 V_{PP} , 5 MHz		-67		dBc
Equivalent Input Noise						
VN	Non-Inverting Voltage	>1 MHz		4.3		nV/ $\sqrt{\text{Hz}}$

±2.5V Electrical Characteristics (Continued)Unless otherwise specified, $A_V = +2$, $R_F = 1200\Omega$, $R_L = 100\Omega$. **Boldface** limits apply at temperature extremes. (Note 2)

Symbol	Parameter	Conditions		Min	Typ	Max	Units
NICN	Inverting Current	>1MHz			6		pA/√Hz
ICN	Non-Inverting Current	>1MHz			6		pA/√Hz
Static, DC Performance							
V_{IO}	Input Offset Voltage				-0.5	±3 ±3.4	mV
I_{BN}	Input Bias Current	Non-Inverting			-2.7	±4 ±5	μA
I_{BI}	Input Bias Current	Inverting			-0.7	±4 ±5	μA
PSRR	Power Supply Rejection Ratio	DC, 0.5V Step	LMH6723	59 57	62		dB
			LMH6724	58 55	62		
			LMH6725	59 56	62		
CMRR	Common Mode Rejection Ratio	DC, 0.5V Step	LMH6723	57 53	59		dB
			LMH6724	55 52	59		
			LMH6725	57 52	59		
I_{CC}	Supply Current (per amplifier)	$R_L = \infty$.9	1.1 1.3	mA
Miscellaneous Performance							
R_{IN+}	Input Resistance	Non-Inverting			100		kΩ
R_{IN-}	Input Resistance (Output Resistance of Input Buffer)	Inverting			500		Ω
C_{IN}	Input Capacitance	Non-Inverting			1.5		pF
R_{OUT}	Output Resistance	Closed Loop			.02		Ω
V_O	Output Voltage Range	$R_L = \infty$		±1.55 ±1.4	±1.65		V
V_{OL}	Output Voltage Range, High	$R_L = 100\Omega$	LMH6723	1.35 1.27	1.45		V
			LMH6724 LMH6725	1.35 1.26	1.45		
	Output Voltage Range, Low	$R_L = 100\Omega$	LMH6723	-1.25 -1.15	-1.38		V
			LMH6724 LMH6725	-1.25 -1.15	-1.38		
CMVR	Input Voltage Range	Common Mode, CMRR > 50 dB		±1.45			V
I_O	Output Current	Sourcing		70 60	90		mA
		Sinking		-30 -30	-60		

Note 1: Absolute Maximum Ratings indicate limits beyond which damage to the device may occur. Operating Ratings indicate conditions for which the device is intended to be functional, but specific performance is not guaranteed. For guaranteed specifications, see the Electrical Characteristics tables.

Note 2: Electrical Table values apply only for factory testing conditions at the temperature indicated. Factory testing conditions result in very limited self-heating of the device such that $T_J = T_A$. No guarantee of parametric performance is indicated in the electrical tables under conditions of internal self heating where $T_J > T_A$. See Applications Section for information on temperature derating of this device. Min/Max ratings are based on product characterization and simulation. Individual parameters are tested as noted.

Note 3: The maximum continuous output current (I_{OUT}) is determined by device power dissipation limitations. See the Power Dissipation section of the Application Section for more details.

Note 4: Human Body Model, 1.5 k Ω in series with 100 pF. Machine Model, 0 Ω In series with 200 pF.

Connection Diagrams

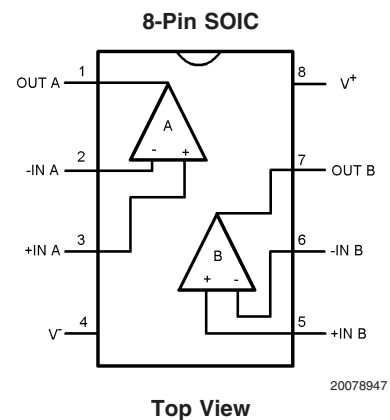
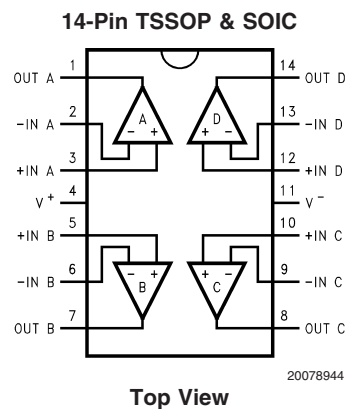
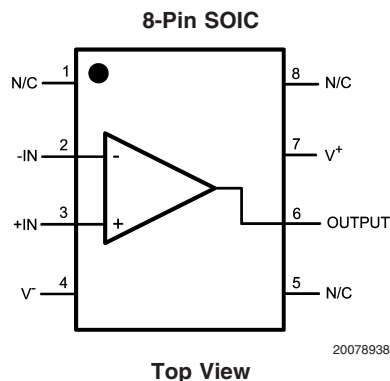
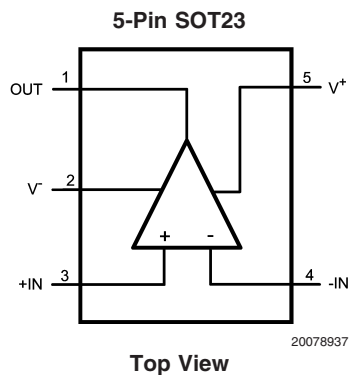

Ordering Information

Package	Part Number	Package Marking	Transport Media	NSC Drawing
5-Pin SOT23	LMH6723MF	AB1A	1k Units Tape and Reel	MF05A
	LMH6723MFX		3k Units Tape and Reel	
8-Pin SOIC	LMH6723MA	LMH6723MA	95 Units/Rail	M08A
	LMH6723MAX		2.5k Units Tape and Reel	
8-Pin SOIC	LMH6724MA	LMH6724MA	95 Units/Rail	M08A
	LMH6724MAX		2.5k Units Tape and Reel	
14-Pin SOIC	LMH6725MA	LMH6725MA	55 Units/Rail	M14A
	LMH6725MAX		2.5k Units Tape and Reel	
14-Pin TSSOP	LMH6725MT	LMH6725MT	94 Units/Rail	MTC14
	LMH6725MTX		2.5k Units Tape and Reel	

Typical Performance Characteristics $A_V = 2, R_F = 1200\Omega, R_L = 100\Omega$, unless otherwise specified.

Frequency Response vs. V_{OUT} , $A_V = 2$

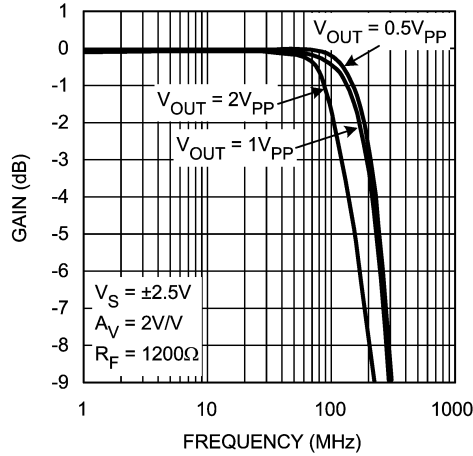

20078928

Frequency Response vs. V_{OUT} , $A_V = 2$

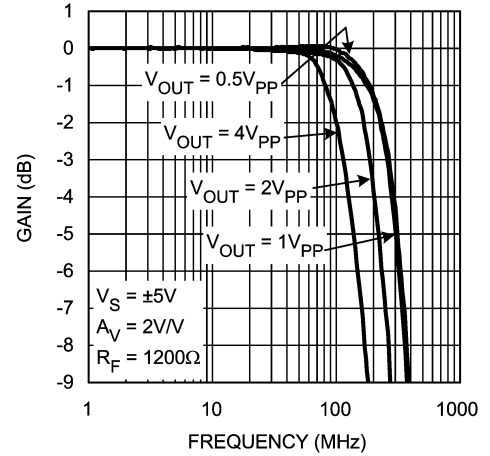

20078926

Frequency Response vs. V_{OUT} , $A_V = 1$

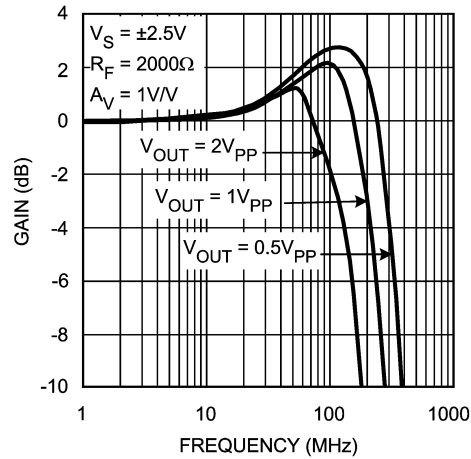

20078929

Frequency Response vs. V_{OUT} , $A_V = 1$

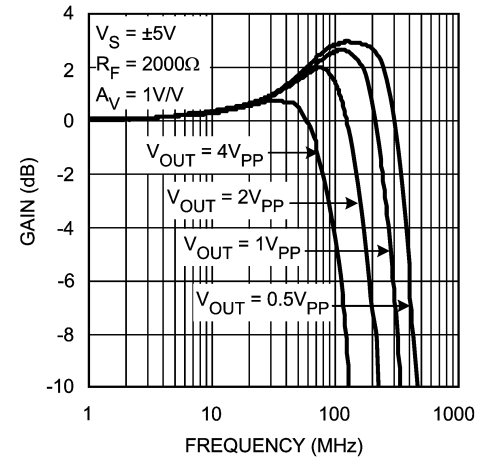

20078927

Large Signal Frequency Response

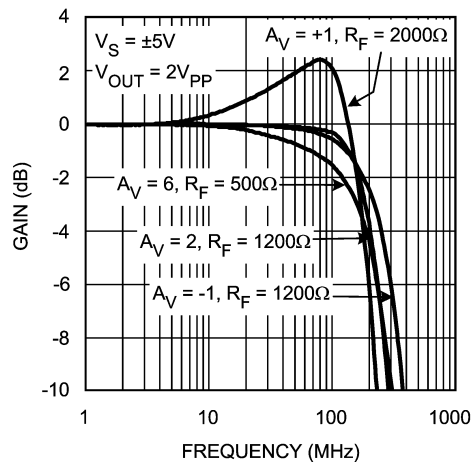

20078921

Frequency Response vs. Supply Voltage

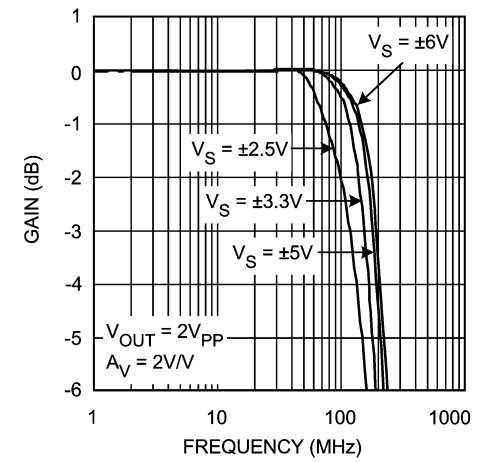

20078930

Typical Performance Characteristics $A_V = 2$, $R_F = 1200\Omega$, $R_L = 100\Omega$, unless otherwise specified. (Continued)

Suggested R_F vs. Gain Non-Inverting

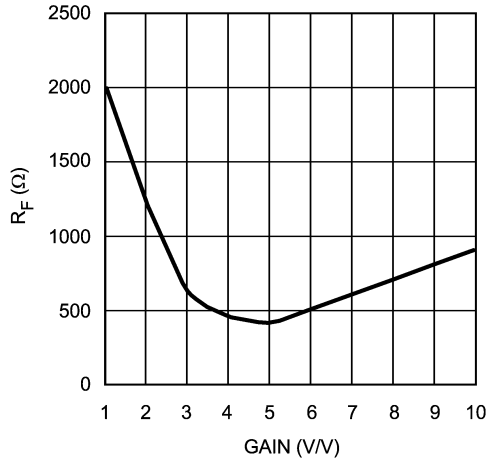

20078905

Suggested R_F vs. Gain Inverting

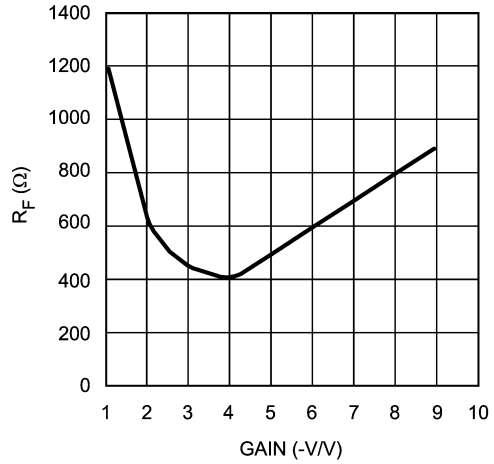

20078906

Frequency Response vs. R_F

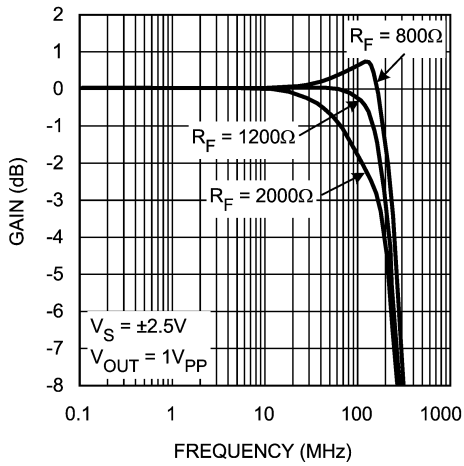

20078922

Frequency Response vs. R_F

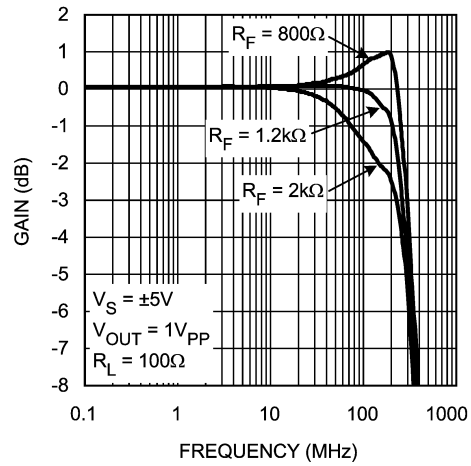

20078923

Open Loop Gain & Phase

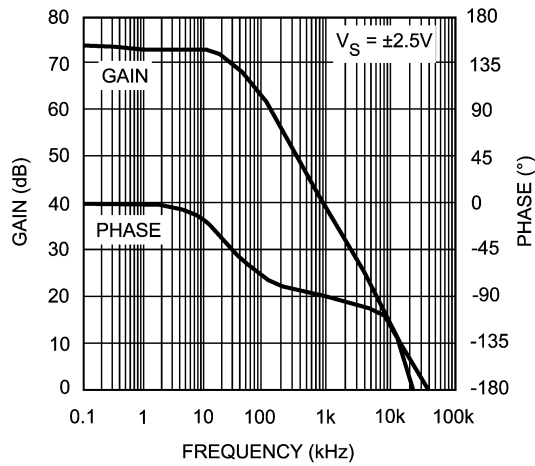

20078917

Open Loop Gain & Phase

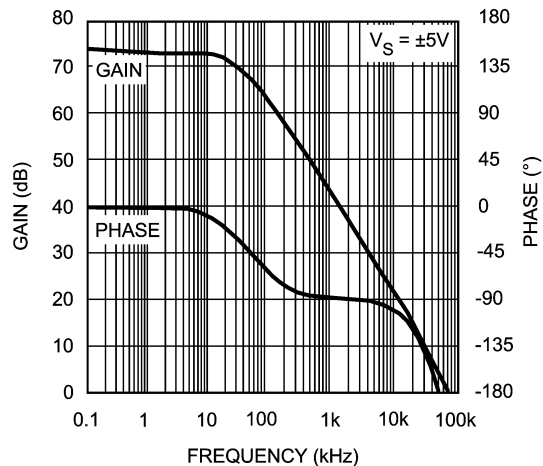

20078918

Typical Performance Characteristics $A_V = 2$, $R_F = 1200\Omega$, $R_L = 100\Omega$, unless otherwise specified. (Continued)

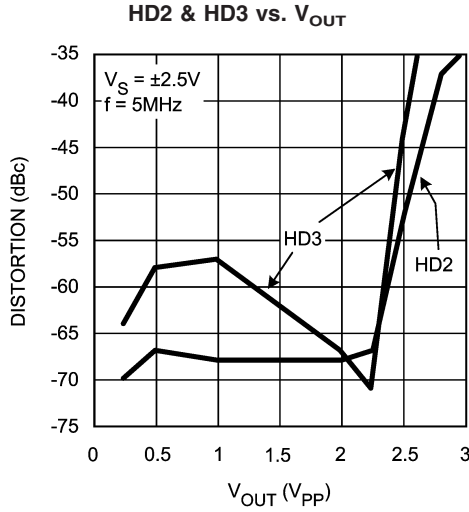

20078911

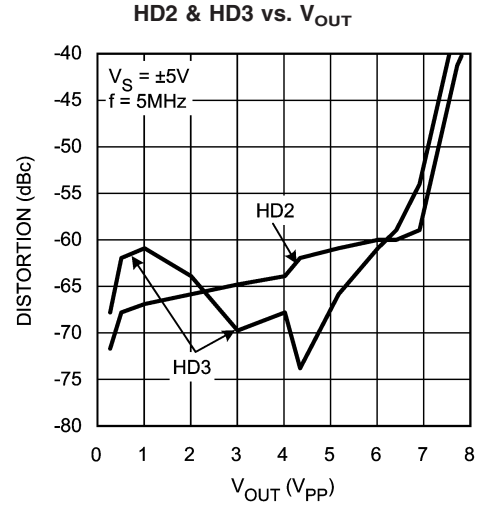

20078913

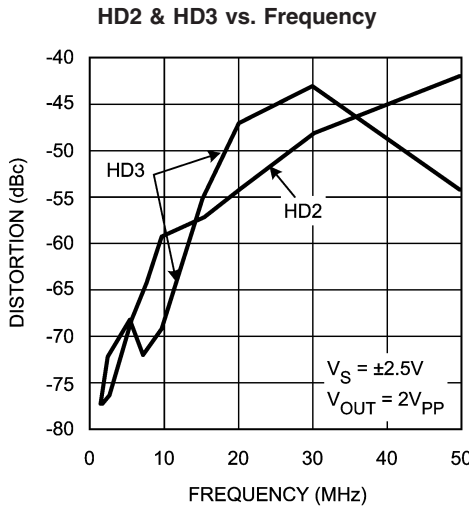

20078912

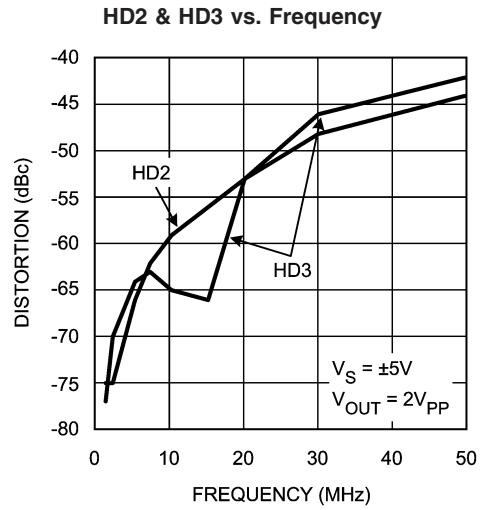

20078914

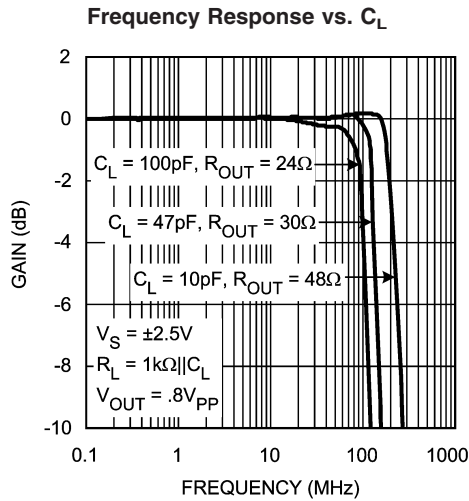

20078925

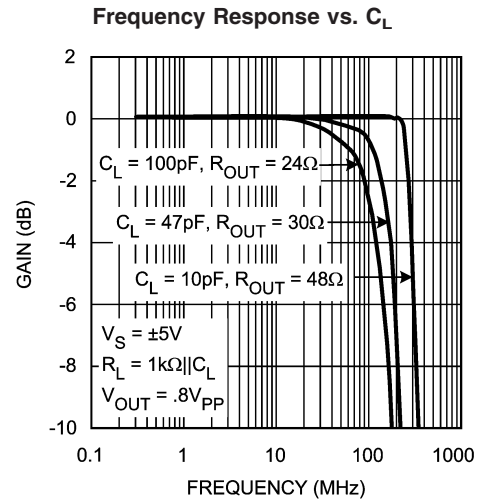

20078924

Typical Performance Characteristics $A_V = 2$, $R_F = 1200\Omega$, $R_L = 100\Omega$, unless otherwise specified. (Continued)

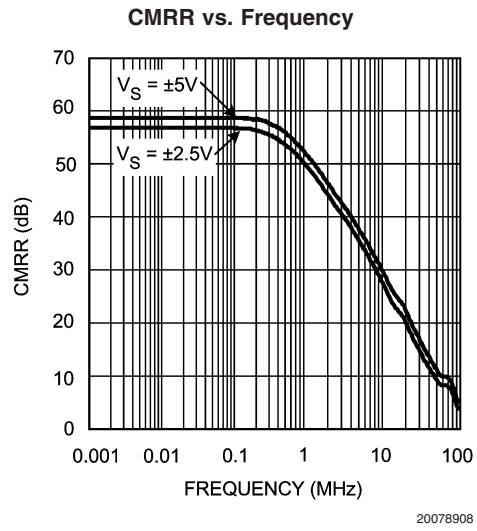
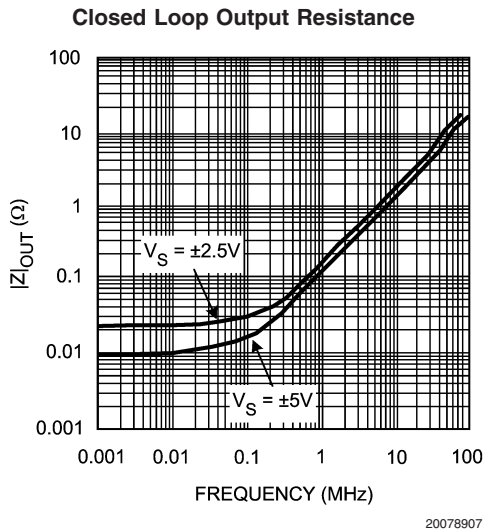
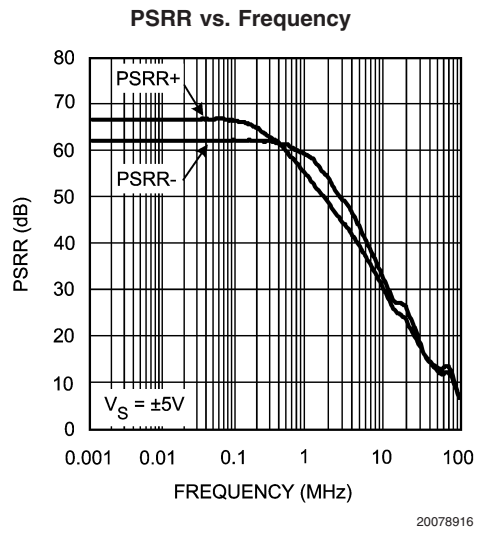
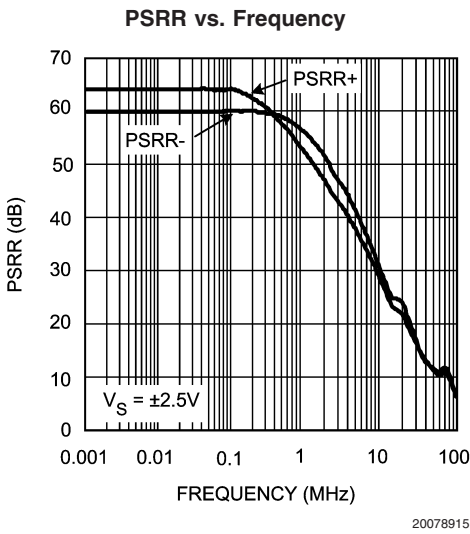
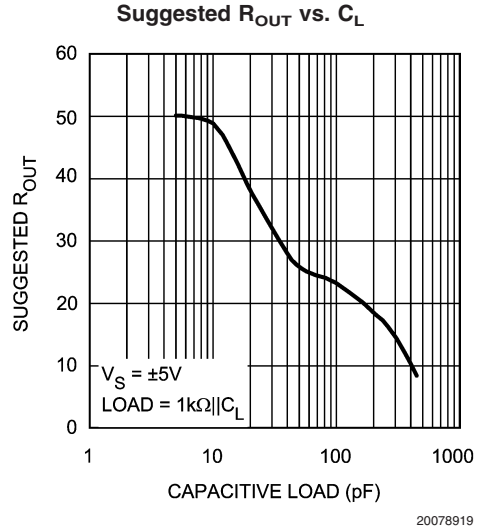
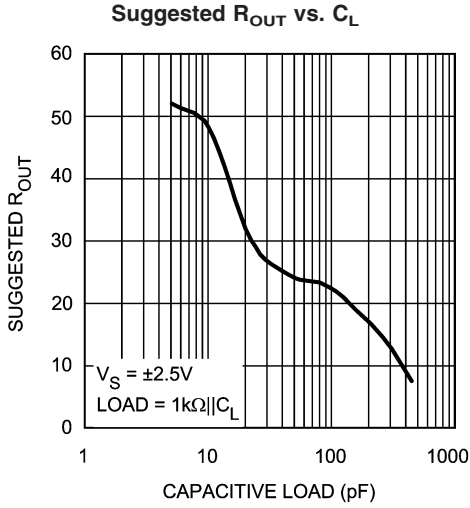

Typical Performance Characteristics $A_V = 2$, $R_F = 1200\Omega$, $R_L = 100\Omega$, unless otherwise specified. (Continued)

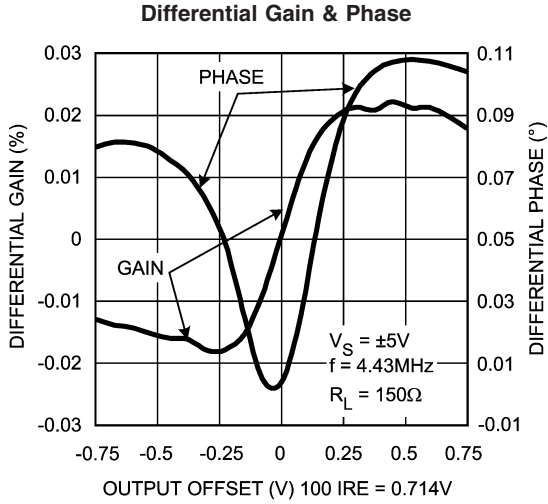

20078910

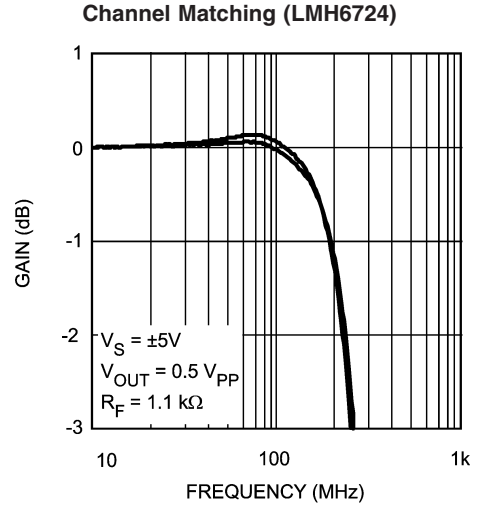

20078948

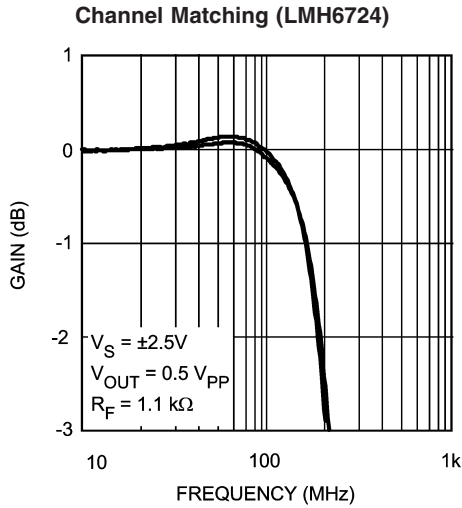

20078949

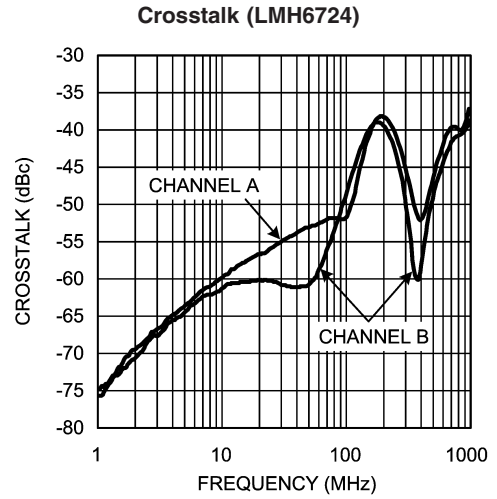

20078946

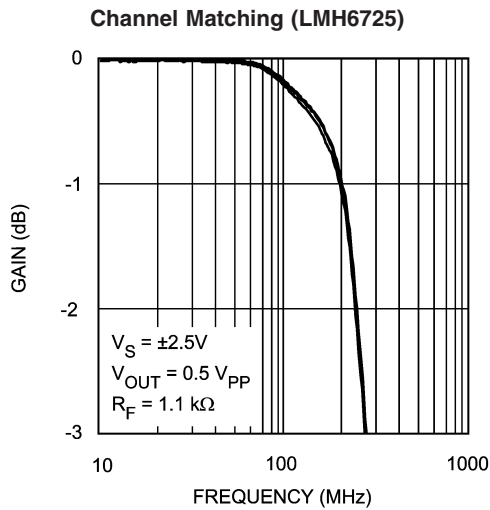

20078940

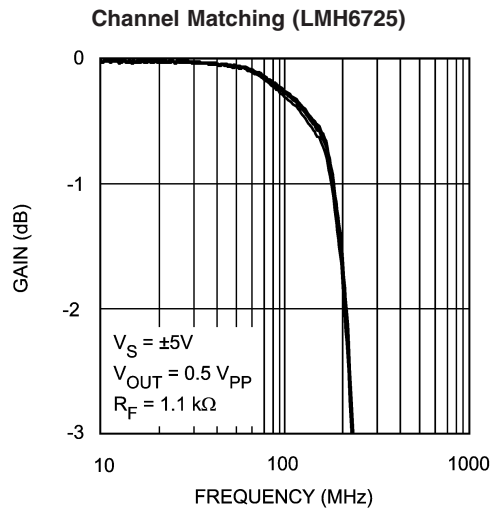

20078941

Typical Performance Characteristics $A_V = 2$, $R_F = 1200\Omega$, $R_L = 100\Omega$, unless otherwise specified. (Continued)

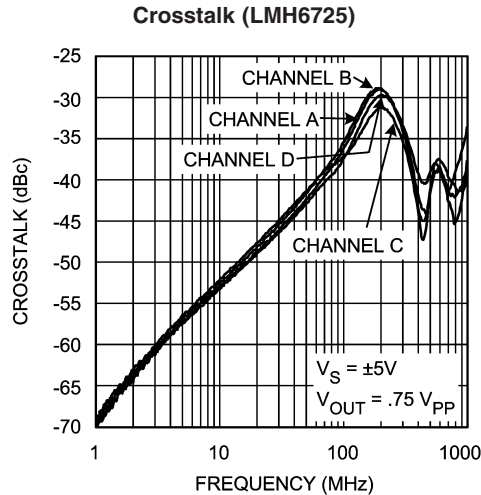

20078945

Application Section

GENERAL INFORMATION

The LMH6723/LMH6724/LMH6725 is a high speed current feedback amplifier manufactured on National Semiconductor's VIP10 (Vertically Integrated PNP) complimentary bipolar process. LMH6723/LMH6724/LMH6725 offers a unique combination of high speed and low quiescent supply current making it suitable for a wide range of battery powered and portable applications that require high performance. This amplifier can operate from 4.5V to 12V nominal supply voltages and draws only 1 mA of quiescent supply current at 10V supplies ($\pm 5V$ typically). The LMH6723/LMH6724/LMH6725 has no internal ground reference so single or split supply configurations are both equally useful.

EVALUATION BOARDS

National Semiconductor provides the following evaluation boards as a guide for high frequency layout and as an aid in device testing and characterization. Many of the datasheet plots were measured with these boards.

Device	Package	Board Part #
LMH6723MA	SOIC-8	CLC730227
LMH6723MF	SOT-23	CLC730216
LMH6724MA	SOIC-8	CLC730036
LMH6725MA	SOIC-14	CLC730231

These evaluation boards can be shipped when a device sample request is placed with National Semiconductor.

FEEDBACK RESISTOR SELECTION

One of the key benefits of a current feedback operational amplifier is the ability to maintain optimum frequency response independent of gain by using appropriate values for the feedback resistor (R_F). The Electrical Characteristics and Typical Performance plots were generated with an R_F of 1200Ω , a gain of $+2V/V$ and $\pm 5V$ or $\pm 2.5V$ power supplies (unless otherwise specified). Generally, lowering R_F from its recommended value will peak the frequency response and extend the bandwidth; however, increasing the value of R_F

will cause the frequency response to roll off faster. Reducing the value of R_F too far below its recommended value will cause overshoot, ringing and, eventually, oscillation.

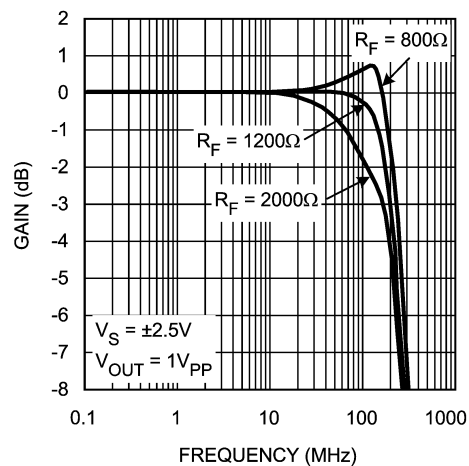

20078922

FIGURE 1. Frequency Response vs. R_F

Figure 1 shows the LMH6723/LMH6724/LMH6725's frequency response as R_F is varied ($R_L = 100\Omega$, $A_V = +2$). This plot shows that an R_F of 800Ω results in peaking. An R_F of 1200Ω gives near maximal bandwidth and gain flatness with good stability. Since each application is slightly different it is worth some experimentation to find the optimal R_F for a given circuit. In general a value of R_F that produces ~ 0.1 dB of peaking is the best compromise between stability and maximal bandwidth. Note that it is not possible to use a current feedback amplifier with the output shorted directly to the inverting input. The buffer configuration of the LMH6723/LMH6724/LMH6725 requires a 2000Ω feedback resistor for stable operation. For other gains see the charts " R_F vs. Non

Application Section (Continued)

Inverting Gain" and "R_F vs. Inverting Gain". These charts provide a good place to start when selecting the best feedback resistor value for a variety of gain settings.

For more information see Application Note OA-13 which describes the relationship between R_F and closed-loop frequency response for current feedback operational amplifiers. The value for the inverting input impedance for the LMH6723/LMH6724/LMH6725 is approximately 500Ω. The LMH6723/LMH6724/LMH6725 is designed for optimum performance at gains of +1 to +5V/V and -1 to -4V/V. Higher gain configurations are still useful; however, the bandwidth will fall as gain is increased, much like a typical voltage feedback amplifier.

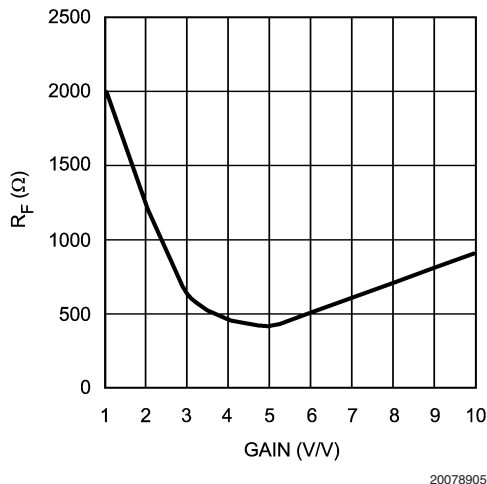

FIGURE 2. RF vs. Non-Inverting Gain

Figure 2 and Figure 3 show the value of R_F versus gain. A higher R_F is required at higher gains to keep R_G from decreasing too far below the input impedance of the inverting input. This limitation applies to both inverting and non-inverting configurations. For the LMH6723/LMH6724/LMH6725 the input resistance of the inverting input is approximately 500Ω and 100Ω is a practical lower limit for R_G. The LMH6723/LMH6724/LMH6725 begins to operate in a gain bandwidth limited fashion in the region where R_F must be increased for higher gains. Note that the amplifier will operate with R_G values well below 100Ω; however, results will be substantially different than predicted from ideal models. In particular, the voltage potential between the Inverting and Non-Inverting inputs cannot be expected to remain small.

For inverting configurations the impedance seen by the source is R_G || R_F. For most sources this limits the maximum inverting gain since R_F is determined by the desired gain as shown in Figure 3. The value of R_G is then R_F/Gain. Thus for an inverting gain of -4 V/V the input impedance is equal to 100Ω. Using a termination resistor, this can be brought down to match a 50Ω or 75Ω source; however, a 150Ω source cannot be matched without a severe compromise in R_F.

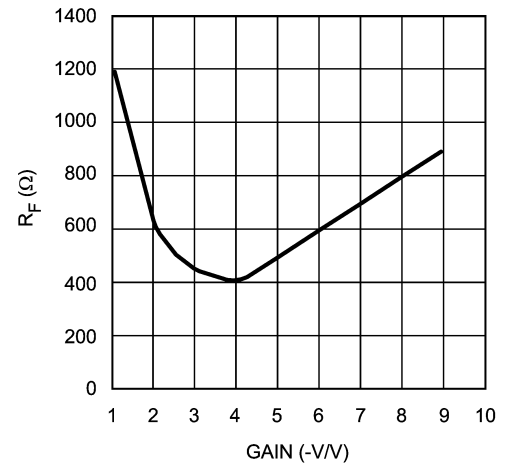

FIGURE 3. R_F vs. Inverting Gain

ACTIVE FILTERS

When using any current feedback operational amplifier as an active filter it is necessary to be careful using reactive components in the feedback loop. Reducing the feedback impedance, especially at higher frequencies, will almost certainly cause stability problems. Likewise capacitance on the inverting input should be avoided. See Application Notes OA-7 and OA-26 for more information on Active Filter applications for Current Feedback Op Amps.

When using the LMH6723/LMH6724/LMH6725 as a low-pass filter the value of R_F can be substantially reduced from the value recommended in the R_F vs. Gain charts. The benefit of reducing R_F is increased gain at higher frequencies, which improves attenuation in the stop band. Stability problems are avoided because in the stop band additional device bandwidth is used to cancel the input signal rather than amplify it. The benefit of this change depends on the particulars of the circuit design. With a high pass filter configuration reducing R_F will likely result in device instability and is not recommended.

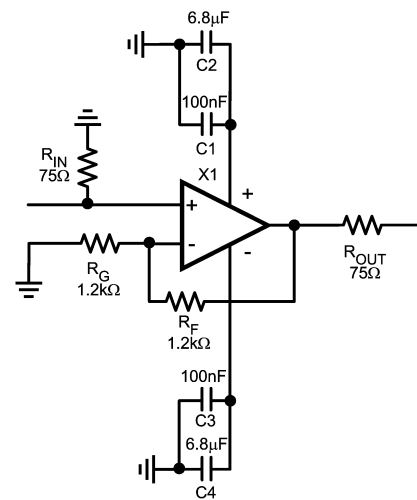

FIGURE 4. Typical Application with Suggested Supply Bypassing

Application Section (Continued)

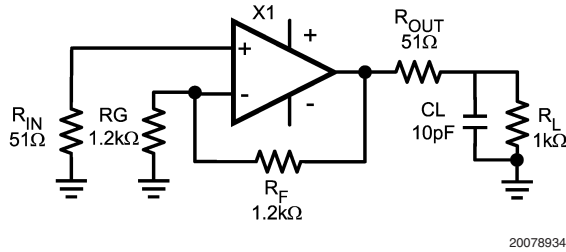

FIGURE 5. Decoupling Capacitive Loads

DRIVING CAPACITIVE LOADS

Capacitive output loading applications will benefit from the use of a series output resistor as shown in *Figure 5*. The charts "Suggested R_{OUT} vs. Cap Load" give a recommended value for selecting a series output resistor for mitigating capacitive loads. The values suggested in the charts are selected for .5 dB or less of peaking in the frequency response. This gives a good compromise between settling time and bandwidth. For applications where maximum frequency response is needed and some peaking is tolerable, the value of R_{OUT} can be reduced slightly from the recommended values.

There will be amplitude lost in the series resistor unless the gain is adjusted to compensate; this effect is most noticeable with heavy loads ($R_L < 150\Omega$).

An alternative approach is to place R_{OUT} inside the feedback loop as shown in *Figure 6*. This will preserve gain accuracy, but will still limit maximum output voltage swing.

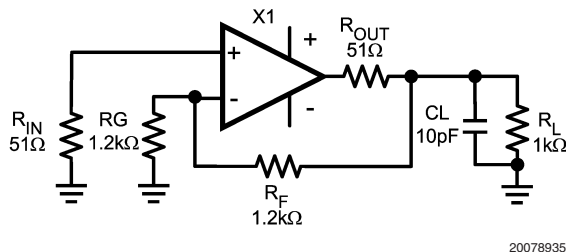

FIGURE 6. Series Output Resistor inside feedback loop

INVERTING INPUT PARASITIC CAPACITANCE

Parasitic capacitance is any capacitance in a circuit that was not intentionally added. It is produced through electrical interaction between conductors and can be reduced but never entirely eliminated. Most parasitic capacitances that cause problems are related to board layout or lack of termination on transmission lines. Please see the section on Layout Considerations for hints on reducing problems due to parasitic capacitances on board traces. Transmission lines should be terminated in their characteristic impedance at both ends.

High speed amplifiers are sensitive to capacitance between the inverting input and ground or power supplies. This shows up as gain peaking at high frequency. The capacitor raises device gain at high frequencies by making R_G appear smaller. Capacitive output loading will exaggerate this effect.

One possible remedy for this effect is to slightly increase the value of the feedback (and gain set) resistor. This will tend to offset the high frequency gain peaking while leaving other parameters relatively unchanged. If the device has a capacitive load as well as inverting input capacitance, using a series output resistor as described in the section on "Driving Capacitive Loads" will help.

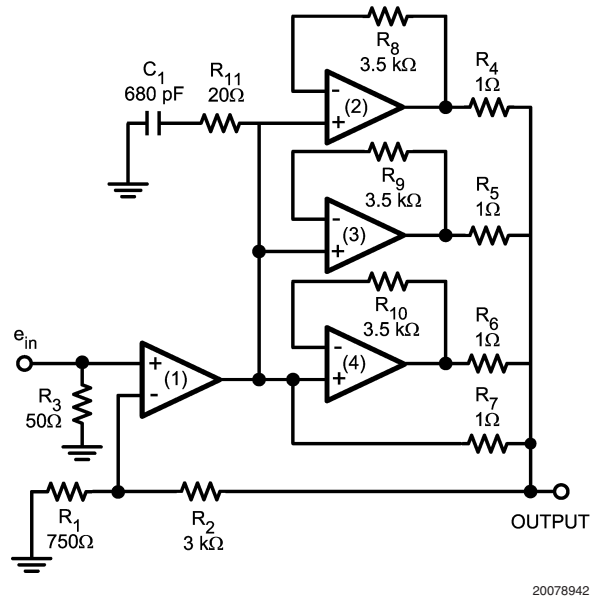

FIGURE 7. High Output Current Composite Amplifier

When higher currents are required than a single amplifier can provide, the circuit of *Figure 7* can be used. Although the example circuit was intended for the LMH6725 quad op amp, higher thermal efficiency can be obtained by using four separate SOIC op amps. Careful attention to a few key components will optimize performance from this circuit. The first thing to note is that the buffers need slightly higher value feedback resistors than if the amplifiers were individually configured. As well, R_{11} and C_1 provide mid circuit frequency compensation to further improve stability. The composite amplifier has approximately twice the phase delay of a single circuit. The larger values of R_8 , R_9 and R_{10} , as well as the high frequency attenuation provided by C_1 and R_{11} , ensure that the circuit does not oscillate.

Resistors R_4 , R_5 , R_6 , and R_7 are necessary to ensure even current distribution between the amplifiers. Since they are inside the feedback loop they have no effect on the gain of the circuit. The circuit shown in *Figure 7* has a gain of 5. The frequency response of this circuit is shown in *Figure 8*.

Application Section (Continued)

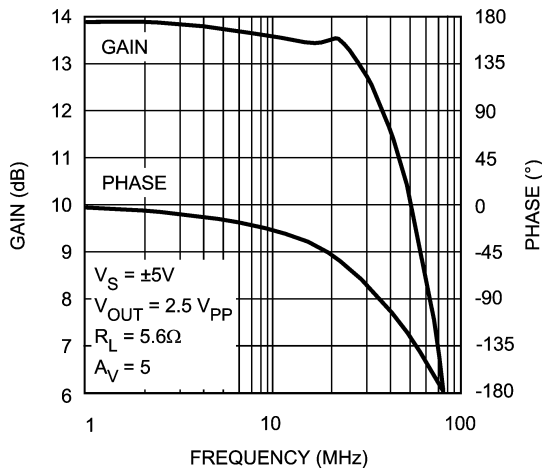

FIGURE 8. Composite Amplifier Frequency Response

LAYOUT CONSIDERATIONS

Whenever questions about layout arise, use the evaluation board as a guide. Evaluation boards are shipped with sample requests.

To reduce parasitic capacitances ground and power planes should be removed near the input and output pins. Components in the feedback loop should be placed as close to the device as possible. For long signal paths controlled impedance lines should be used, along with impedance matching at both ends.

Bypass capacitors should be placed as close to the device as possible. Bypass capacitors from each rail to ground are applied in pairs. The larger electrolytic bypass capacitors can be located anywhere on the board; however, the smaller ceramic capacitors should be placed as close to the device as possible.

VIDEO PERFORMANCE

The LMH6723/LMH6724/LMH6725 has been designed to provide good performance with both PAL and NTSC composite video signals. The LMH6723/LMH6724/LMH6725 is specified for PAL signals. Typically, NTSC performance is marginally better due to the lower frequency content of the signal. Performance degrades as the loading is increased;

therefore, best performance will be obtained with back terminated loads. The back termination reduces reflections from the transmission line and effectively masks transmission line and other parasitic capacitances from the amplifier output stage. Figure 4 shows a typical configuration for driving a 75Ω cable. The amplifier is configured for a gain of 2 to make up for the 6dB of loss in R_{OUT} .

SINGLE 5V SUPPLY VIDEO

With a 5V supply the LMH6723/LMH6724/LMH6725 is able to handle a composite NTSC video signal, provided that the signal is AC coupled and level shifted so that the signal is centered around $V_{CC}/2$.

POWER DISSIPATION

Follow these steps to determine the maximum power dissipation for the LMH6723/LMH6724/LMH6725:

1. Calculate the quiescent (no-load) power: $P_{AMP} = I_{CC} \cdot (V_S) V_S = V^+ - V^-$
2. Calculate the RMS power dissipated in the output stage: $P_D (rms) = rms ((V_S - V_{OUT}) \cdot I_{OUT})$ where V_{OUT} and I_{OUT} are the voltage and current across the external load and V_S is the total supply current.
3. Calculate the total RMS power: $P_T = P_{AMP} + P_D$

The maximum power that the LMH6723/LMH6724/LMH6725 package can dissipate at a given temperature can be derived with the following equation:

$P_{MAX} = (150^\circ - T_{AMB}) / \theta_{JA}$, where T_{AMB} = Ambient temperature ($^\circ C$) and θ_{JA} = Thermal resistance, from junction to ambient, for a given package ($^\circ C/W$). For the SOIC-8 package θ_{JA} is $166^\circ C/W$ and for the SOT it is $230^\circ C/W$. The SOIC-14 has a θ_{JA} of $130^\circ C/W$. The TSSOP-14 has a θ_{JA} of $160^\circ C/W$.

ESD PROTECTION

The LMH6723/LMH6724/LMH6725 is protected against electrostatic discharge (ESD) on all pins. The LMH6723/LMH6725 will survive 2000V Human Body Model or 200V Machine Model events.

Under closed loop operation the ESD diodes have no effect on circuit performance. There are occasions, however, when the ESD diodes will be evident. If the LMH6723/LMH6724/LMH6725 is driven into a slewing condition the ESD diodes will clamp large differential voltages until the feedback loop restores closed loop operation. Also, if the device is powered down and a large input signal is applied, the ESD diodes will conduct.

Physical Dimensions inches (millimeters)

unless otherwise noted

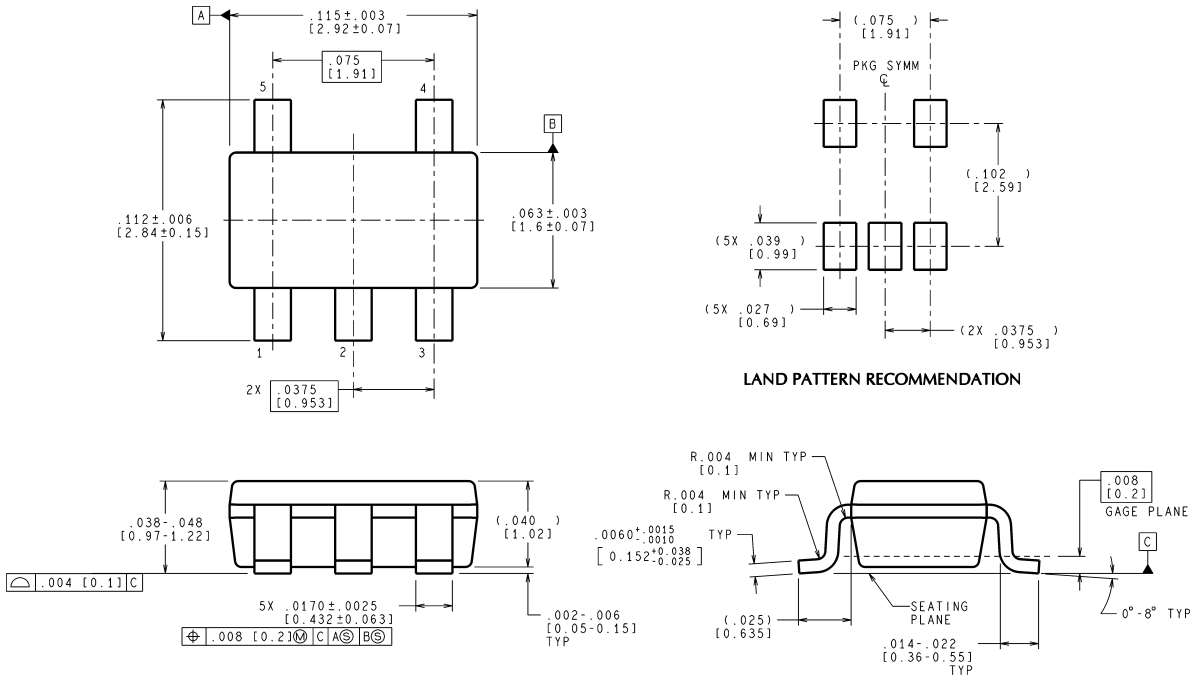

CONTROLLING DIMENSION IS INCH
VALUES IN [] ARE MILLIMETERS

MF05A (Rev B)

5-Pin SOT23 NS Product Number MF05A

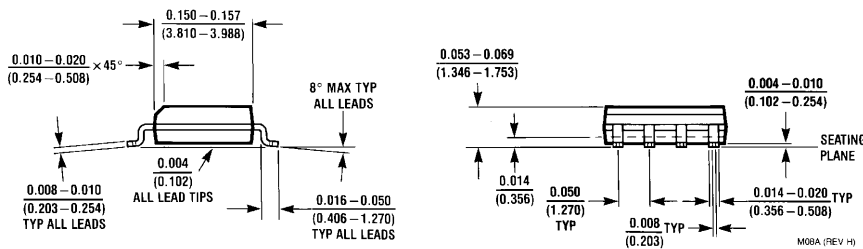
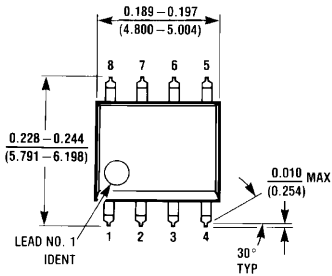

8-Pin SOIC NS Product Number M08A

Physical Dimensions inches (millimeters) unless otherwise noted (Continued)

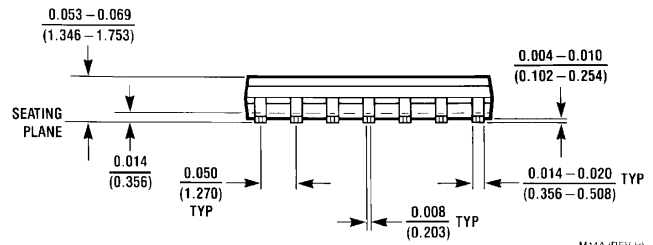
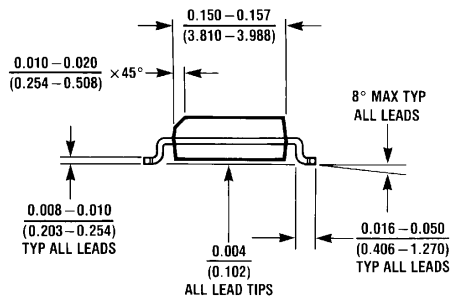
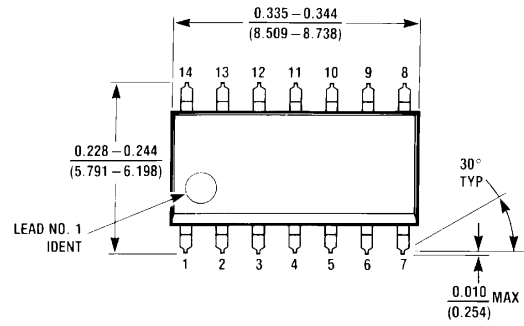

M14A (REV H)

**14-Pin SOIC
NS Product Number M14A**

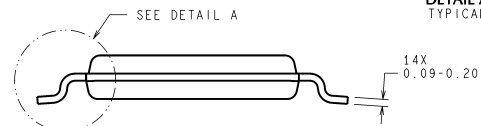
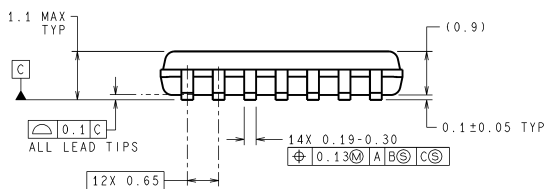
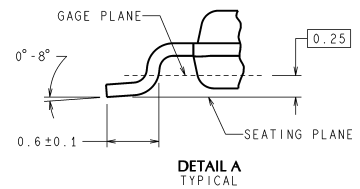
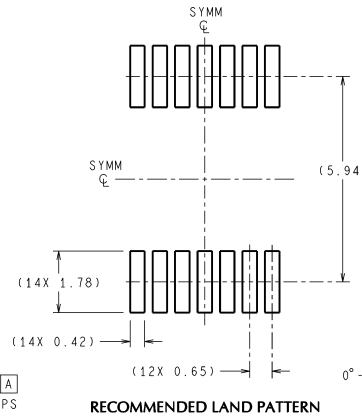
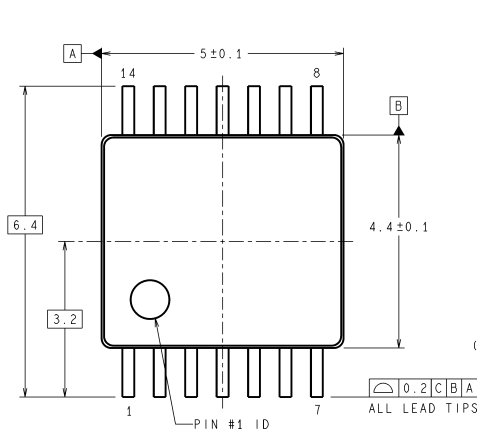

DIMENSIONS ARE IN MILLIMETERS
DIMENSIONS IN () FOR REFERENCE ONLY

MTC14 (Rev D)

**14-Pin TSSOP
NS Product Number MTC14**

Notes

National does not assume any responsibility for use of any circuitry described, no circuit patent licenses are implied and National reserves the right at any time without notice to change said circuitry and specifications.
 For the most current product information visit us at www.national.com.

LIFE SUPPORT POLICY

NATIONAL'S PRODUCTS ARE NOT AUTHORIZED FOR USE AS CRITICAL COMPONENTS IN LIFE SUPPORT DEVICES OR SYSTEMS WITHOUT THE EXPRESS WRITTEN APPROVAL OF THE PRESIDENT AND GENERAL COUNSEL OF NATIONAL SEMICONDUCTOR CORPORATION. As used herein:

- | | |
|--|---|
| <p>1. Life support devices or systems are devices or systems which, (a) are intended for surgical implant into the body, or (b) support or sustain life, and whose failure to perform when properly used in accordance with instructions for use provided in the labeling, can be reasonably expected to result in a significant injury to the user.</p> | <p>2. A critical component is any component of a life support device or system whose failure to perform can be reasonably expected to cause the failure of the life support device or system, or to affect its safety or effectiveness.</p> |
|--|---|

BANNED SUBSTANCE COMPLIANCE

National Semiconductor manufactures products and uses packing materials that meet the provisions of the Customer Products Stewardship Specification (CSP-9-111C2) and the Banned Substances and Materials of Interest Specification (CSP-9-111S2) and contain no "Banned Substances" as defined in CSP-9-111S2.

Leadfree products are RoHS compliant.



National Semiconductor
Americas Customer
Support Center
 Email: new.feedback@nsc.com
 Tel: 1-800-272-9959

National Semiconductor
Europe Customer Support Center
 Fax: +49 (0) 180-530 85 86
 Email: europe.support@nsc.com
 Deutsch Tel: +49 (0) 69 9508 6208
 English Tel: +44 (0) 870 24 0 2171
 Français Tel: +33 (0) 1 41 91 8790

National Semiconductor
Asia Pacific Customer
Support Center
 Email: ap.support@nsc.com

National Semiconductor
Japan Customer Support Center
 Fax: 81-3-5639-7507
 Email: jpn.feedback@nsc.com
 Tel: 81-3-5639-7560

IMPORTANT NOTICE

Texas Instruments Incorporated and its subsidiaries (TI) reserve the right to make corrections, modifications, enhancements, improvements, and other changes to its products and services at any time and to discontinue any product or service without notice. Customers should obtain the latest relevant information before placing orders and should verify that such information is current and complete. All products are sold subject to TI's terms and conditions of sale supplied at the time of order acknowledgment.

TI warrants performance of its hardware products to the specifications applicable at the time of sale in accordance with TI's standard warranty. Testing and other quality control techniques are used to the extent TI deems necessary to support this warranty. Except where mandated by government requirements, testing of all parameters of each product is not necessarily performed.

TI assumes no liability for applications assistance or customer product design. Customers are responsible for their products and applications using TI components. To minimize the risks associated with customer products and applications, customers should provide adequate design and operating safeguards.

TI does not warrant or represent that any license, either express or implied, is granted under any TI patent right, copyright, mask work right, or other TI intellectual property right relating to any combination, machine, or process in which TI products or services are used. Information published by TI regarding third-party products or services does not constitute a license from TI to use such products or services or a warranty or endorsement thereof. Use of such information may require a license from a third party under the patents or other intellectual property of the third party, or a license from TI under the patents or other intellectual property of TI.

Reproduction of TI information in TI data books or data sheets is permissible only if reproduction is without alteration and is accompanied by all associated warranties, conditions, limitations, and notices. Reproduction of this information with alteration is an unfair and deceptive business practice. TI is not responsible or liable for such altered documentation. Information of third parties may be subject to additional restrictions.

Resale of TI products or services with statements different from or beyond the parameters stated by TI for that product or service voids all express and any implied warranties for the associated TI product or service and is an unfair and deceptive business practice. TI is not responsible or liable for any such statements.

TI products are not authorized for use in safety-critical applications (such as life support) where a failure of the TI product would reasonably be expected to cause severe personal injury or death, unless officers of the parties have executed an agreement specifically governing such use. Buyers represent that they have all necessary expertise in the safety and regulatory ramifications of their applications, and acknowledge and agree that they are solely responsible for all legal, regulatory and safety-related requirements concerning their products and any use of TI products in such safety-critical applications, notwithstanding any applications-related information or support that may be provided by TI. Further, Buyers must fully indemnify TI and its representatives against any damages arising out of the use of TI products in such safety-critical applications.

TI products are neither designed nor intended for use in military/aerospace applications or environments unless the TI products are specifically designated by TI as military-grade or "enhanced plastic." Only products designated by TI as military-grade meet military specifications. Buyers acknowledge and agree that any such use of TI products which TI has not designated as military-grade is solely at the Buyer's risk, and that they are solely responsible for compliance with all legal and regulatory requirements in connection with such use.

TI products are neither designed nor intended for use in automotive applications or environments unless the specific TI products are designated by TI as compliant with ISO/TS 16949 requirements. Buyers acknowledge and agree that, if they use any non-designated products in automotive applications, TI will not be responsible for any failure to meet such requirements.

Following are URLs where you can obtain information on other Texas Instruments products and application solutions:

Products

Audio	www.ti.com/audio
Amplifiers	amplifier.ti.com
Data Converters	dataconverter.ti.com
DLP® Products	www.dlp.com
DSP	dsp.ti.com
Clocks and Timers	www.ti.com/clocks
Interface	interface.ti.com
Logic	logic.ti.com
Power Mgmt	power.ti.com
Microcontrollers	microcontroller.ti.com
RFID	www.ti-rfid.com
OMAP Mobile Processors	www.ti.com/omap
Wireless Connectivity	www.ti.com/wirelessconnectivity

Applications

Communications and Telecom	www.ti.com/communications
Computers and Peripherals	www.ti.com/computers
Consumer Electronics	www.ti.com/consumer-apps
Energy and Lighting	www.ti.com/energy
Industrial	www.ti.com/industrial
Medical	www.ti.com/medical
Security	www.ti.com/security
Space, Avionics and Defense	www.ti.com/space-avionics-defense
Transportation and Automotive	www.ti.com/automotive
Video and Imaging	www.ti.com/video

TI E2E Community Home Page

e2e.ti.com

Mailing Address: Texas Instruments, Post Office Box 655303, Dallas, Texas 75265
Copyright © 2011, Texas Instruments Incorporated