

QUAD DIFFERENTIAL PECL DRIVERS

FEATURES

- Functional Replacements for the Agere BDG1A, BPNGA and BDGLA
- Pin-Equivalent to the General-Trade 26LS31 Device
- 2.0 ns Maximum Propagation Delays
- 0.15 ns Output Skew Typical Between Pairs
- Capable of Driving 50-Ω Loads
- 5.0-V or 3.3-V Supply Operation
- TB5D1M Includes Surge Protection on Differential Outputs
- TB5D2H No Line Loading When $V_{CC} = 0$
- Third State Output Capability
- -40C to 85C Operating Temp Range
- ESD Protection HBM > 3 kV and CDM > 2 kV
- Available in Gull-Wing SOIC (JEDEC MS-013, DW) and SOIC (D) Packages

APPLICATIONS

- Digital Data or Clock Transmission Over Balanced Transmission Lines

DESCRIPTION

These quad differential drivers are TTL input to pseudo-ECL differential output used for digital data transmission over balanced transmission lines.

The TB5D1M device is a pin and functional replacement for the Agere systems BDG1A and BPNGA quad differential drivers. The TB5D1M has a built-in lightning protection circuit to absorb large transitions on the transmission lines without destroying the device. When the circuit is powered down it loads the transmission line, because of the protection circuit.

The TB5D2H device is a pin and functional replacement for the Agere systems BDG1A and BDGLA quad differential drivers. Upon power down the TB5D2H output circuit appears as an open circuit and does not load the transmission line.

Both drivers feature a 3-state output with a third-state level of less than 0.1 V.

The packaging options available for these quad differential line drivers include a 16-pin SOIC gull-wing (DW) and a 16-pin SOIC (D) package.

Both drivers are characterized for operation from -40C to 85C

The logic inputs of this device include internal pull-up resistors of approximately 40 kΩ that are connected to V_{CC} to ensure a logical high level input if the inputs are open circuited.

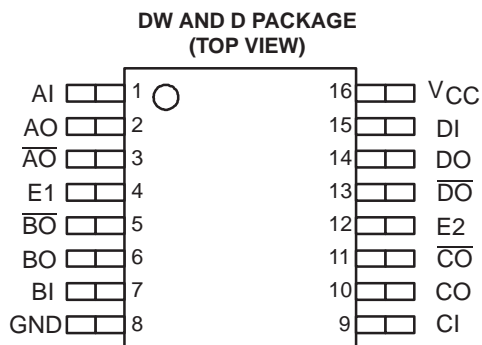

FUNCTIONAL DIAGRAM

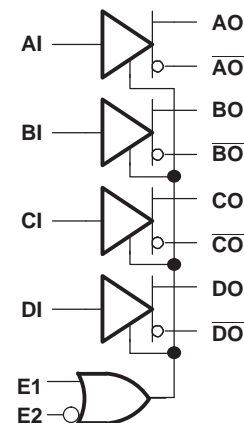

ENABLE TRUTH TABLE

E1	E2	Condition
0	0	Active
1	0	Active
0	1	Disabled
1	1	Active



Please be aware that an important notice concerning availability, standard warranty, and use in critical applications of Texas Instruments semiconductor products and disclaimers thereto appears at the end of this data sheet.



These devices have limited built-in ESD protection. The leads should be shorted together or the device placed in conductive foam during storage or handling to prevent electrostatic damage to the MOS gates.

ORDERING INFORMATION

PART NUMBER	PART MARKING	PACKAGE	LEAD FINISH	STATUS
TB5D1MDW	TB5D1M	Gull-wing SOIC	NiPdAu	Production
TB5D1MD	TB5D1M	SOIC	NiPdAu	Production
TB5D2HDW	TB5D2H	Gull-wing SOIC	NiPdAu	Production
TB5D2HD	TB5D2H	SOIC	NiPdAu	Production

PACKAGE DISSIPATION RATINGS

PACKAGE	CIRCUIT BOARD MODEL	$T_A \leq 25^\circ\text{C}$ POWER RATING	THERMAL RESISTANCE, JUNCTION-TO-AMBIENT WITH NO AIR FLOW	DERATING FACTOR ⁽¹⁾ ABOVE $T_A = 25^\circ\text{C}$	$T_A = 85^\circ\text{C}$ POWER RATING
D	Low-K ⁽²⁾	754 mW	132.6 C/W	7.54 mW/C	301 mW
	High-K ⁽³⁾	1166 mW	85.8 C/W	11.7 mW/C	466 mW
DW	Low-K ⁽²⁾	816 mW	122.5 C/W	8.17 mW/C	326 mW
	High-K ⁽³⁾	1206 mW	82.9 C/W	12.1 mW/C	482 mW

(1) This is the inverse of the junction-to-ambient thermal resistance when board-mounted with no air flow.

(2) In accordance with the low-K thermal metric definitions of EIA/JESD51-3.

(3) In accordance with the high-K thermal metric definitions of EIA/JESD51-7.

THERMAL CHARACTERISTICS

PARAMETER		PACKAGE	VALUE	UNITS
θ_{JB}	Junction-to-board thermal resistance	D	51.4	C/W
		DW	56.6	C/W
θ_{JC}	Junction-to-case thermal resistance	D	45.7	C/W
		DW	49.2	C/W

ABSOLUTE MAXIMUM RATINGS

over operating free-air temperature range unless otherwise noted⁽¹⁾

			TB5D1M, TB5D2H
Supply voltage, V_{CC}			0 V to 6 V
Input voltage			-0.3 V to ($V_{CC} + 0.3$ V)
ESD	Human Body Model ⁽²⁾	All Pins	3 kV
	Charged-Device Model ⁽³⁾	All Pins	2 kV
Continuous power dissipation			See Dissipation Rating Table
Storage temperature, T_{stg}			-65°C to 130°C
Junction temperature, T_J			130°C
Lightning surge, TB5D1M only, see Figure 6	D Package		-80 V to 100 V
	DW Package		-100 V to 100 V

(1) Stresses beyond those listed under *absolute maximum ratings* may cause permanent damage to the device. These are stress ratings only, and functional operation of the device at these or any other conditions beyond those indicated under *recommended operating conditions* is not implied. Exposure to absolute-maximum-rated conditions for extended periods may affect device reliability.

(2) Tested in accordance with JEDEC Standard 22, Test Method A114-A.

(3) Tested in accordance with JEDEC Standard 22, Test Method C101.

RECOMMENDED OPERATING CONDITIONS⁽¹⁾

		MIN	NOM	MAX	UNIT
Supply voltage, V_{CC}	5.0-V nominal supply	4.5	5	5.5	V
	3.3-V nominal supply	3.0	3.3	3.6	V
Operating free-air temperature, T_A		-40		85	C

(1) The algebraic convention, in which the least positive (most negative) limit is designated as minimum is used in this data sheet, unless otherwise stated.

ELECTRICAL CHARACTERISTICS

over recommended operating conditions unless otherwise noted

parameter	test conditions	min	typ ⁽¹⁾	max	unit
I_{CC} Supply current	$V_{CC} = 4.5\text{ V to }5.5\text{ V}$, no loads			40	mA
	$V_{CC} = 3.0\text{ V to }3.6\text{ V}$, no loads			40	
P_D Power dissipation	$V_{CC} = 4.5\text{ V to }5.5\text{ V}$, Figure 3 loads all outputs		290	360	mW
	$V_{CC} = 3.0\text{ V to }3.6\text{ V}$, Figure 4 loads all outputs		280	360	
V_{OH} Output high voltage	$V_{CC} = 4.5\text{ V to }5.5\text{ V}$, Figure 3	$V_{CC} - 1.8$	$V_{CC} - 1.3$	$V_{CC} - 0.8$	V
V_{OL} Output low voltage		$V_{OH} - 1.4$	$V_{OH} - 1.2$	$V_{OH} - 0.7$	V
V_{OD} Differential output voltage $ V_{OH} - V_{OL} $		0.7	1.2	1.4	V
V_{OH} Output high voltage	$V_{CC} = 3.0\text{ V to }3.6\text{ V}$, Figure 4	$V_{CC} - 1.8$	$V_{CC} - 1.3$	$V_{CC} - 0.8$	V
V_{OL} Output low voltage		$V_{OH} - 1.4$	$V_{OH} - 1.1$	$V_{OH} - 0.5$	V
V_{OD} Differential output voltage $ V_{OH} - V_{OL} $		0.5	1.1	1.4	V
$V_{OC(PP)}$ Peak-to-peak common-mode output voltage	$C_L = 5\text{ pF}$, Figure 5		230	600	mV
V_{OZ} Third-state output voltage	Figure 3 or Figure 4 load			0.1	V
V_{IL} Low level input voltage ⁽²⁾				0.8	V
V_{IH} High level input voltage		2			V
V_{IK} Enable input clamp voltage	$V_{CC} = 4.5\text{ V}$, $I_I = -5\text{ mA}$			-1 ⁽³⁾	V
I_{OS} Output short-circuit current ⁽⁴⁾	$V_{CC} = 5.5\text{ V}$, $V_O = 0\text{ V}$			-250 ⁽³⁾	mA
	$V_{CC} = 5.5\text{ V}$, $V_{OD} = 0\text{ V}$			10 ⁽³⁾	
I_{IL} Input low current, enable or data	$V_{CC} = 5.5\text{ V}$, $V_I = 0.4\text{ V}$			-400 ⁽³⁾	A
I_{IH}	Input high current, enable or data			20	A
	Input reverse current, enable or data			100	A
C_{IN} Input capacitance			5		pF

(1) All typical values are at 25C and with a 3.3-V or 5-V supply.

(2) The input level provides no noise immunity and should be tested only in a static, noise-free environment.

(3) This parameter is listed using a magnitude and polarity/direction convention, rather than an algebraic convention, to match the original Agere data sheet.

(4) Test must be performed one output at a time to prevent damage to the device. No test circuit attached.

THIRD STATE—A TB5D1M (or TB5D2H) driver produces pseudo-ECL levels, and has a third-state mode, which is different than a conventional TTL device. When a TB5D1M (or TB5D2H) driver is placed in the third state, the base of the output transistors is pulled low, bringing the outputs below the active-low level of standard PECL devices. [For example: The TB5D1M low output level is typically 2.7 V, while the third state output level is less than 0.1 V.] In a bidirectional, multipoint, bus application, the driver of one device, which is in its third state, may be back driven by another driver on the bus whose voltage in the low state is lower than the third-stated device. This could come about due to differences in the driver's independent power supplies. In this case, the device in the third state controls the line, thus clamping the line and reducing the signal swing. If the difference voltage between the independent driver power supplies is small, this consideration can be ignored. Again using the TB5D1M driver as an example, a typical supply voltage difference between separate drivers of > 2 V can exist without significantly affecting the amplitude of the signal.

SWITCHING CHARACTERISTICS, 5-V NOMINAL SUPPLY

over recommended operating conditions unless otherwise noted

parameter	test conditions	min	typ ⁽¹⁾	max	unit
t_{P1}	Propagation delay time, input high to output ⁽²⁾		1.2	2	ns
t_{P2}	Propagation delay time, input low to output ⁽²⁾		1.2	2	
Δt_p	Capacitive delay		0.01	0.03	ns/pF
t_{PHZ}	Propagation delay time, high-level-to-high-impedance output		7	12	ns
t_{PLZ}	Propagation delay time, low-level-to-high-impedance output	$C_L = 5$ pF, See Figure 2 and Figure 3	7	12	
t_{PZH}	Propagation delay time, high-impedance-to-high-level output		5	12	
t_{PZL}	Propagation delay time, high-impedance-to-low-level output		4	12	
t_{skew1}	Output skew, $ t_{P1} - t_{P2} $		0.15	0.3	ns
t_{shew2}	Output skew, $ t_{PHH} - t_{PHL} , t_{PLH} - t_{PLL} $	$C_L = 5$ pF, See Figure 1 and Figure 3	0.15	1.1	
$t_{skew(pp)}$	Part-to-part skew ⁽³⁾		0.1	1	
Δt_{skew}	Output skew, difference between drivers ⁽⁴⁾			0.3	
t_{TLH}	Rise time (20% - 80%)	$C_L = 5$ pF, See Figure 1 and Figure 3	0.7	2	ns
t_{THL}	Fall time (80% - 20%)		0.7	2	

(1) All typical values are at 25°C and with a 5-V supply.

(2) Parameters t_{P1} and t_{P2} are measured from the 1.5 V point of the input to the crossover point of the outputs (see [Figure 1](#)).

(3) $t_{skew(pp)}$ is the magnitude of the difference in differential propagation delay times, t_{P1} or t_{P2} , between any specified outputs of two devices when both devices operate with the same supply voltage, at the same temperature, and have identical packages and test circuits.

(4) Δt_{skew} is the magnitude of the difference in differential skew t_{skew1} between any specified outputs of a single device.

SWITCHING CHARACTERISTICS, 3.3-V NOMINAL SUPPLY

over recommended operating conditions unless otherwise noted

parameter		test conditions	min	typ ⁽¹⁾	max	unit
t_{P1}	Propagation delay time, input high to output ⁽²⁾	$C_L = 5$ pF, See Figure 1 and Figure 4	1.2	3.5		ns
t_{P2}	Propagation delay time, input low to output ⁽²⁾		1.2	3.5		
Δt_p	Capacitive delay		0.01	0.03		ns/pF
t_{PHZ}	Propagation delay time, high-level-to-high-impedance output	$C_L = 5$ pF, See Figure 2 and Figure 4	8	12		ns
t_{PLZ}	Propagation delay time, low-level-to-high-impedance output		5	12		
t_{PZH}	Propagation delay time, high-impedance-to-high-level output		5	12		
t_{PZL}	Propagation delay time, high-impedance-to-low-level output		8	12		
t_{skew1}	Output skew, $ t_{P1} - t_{P2} $	$C_L = 5$ pF, See Figure 1 and Figure 4	0.15	0.3		ns
t_{shew2}	Output skew, $ t_{PHH} - t_{PHL} , t_{PLH} - t_{PLL} $		0.15	1.2		
$t_{skew(pp)}$	Part-to-part skew ⁽³⁾		0.1	1		
Δt_{skew}	Output skew, difference between drivers ⁽⁴⁾			0.3		
t_{TLH}	Rise time (20% - 80%)	$C_L = 5$ pF, See Figure 1 and Figure 4	0.7	2		ns
t_{THL}	Fall time (80% - 20%)		0.7	2		

- (1) All typical values are at 25°C and with a 3.3-V supply.
- (2) Parameters t_{P1} and t_{P2} are measured from the 1.5 V point of the input to the crossover point of the outputs (see [Figure 1](#)).
- (3) $t_{skew(pp)}$ is the magnitude of the difference in differential propagation delay times, t_{P1} or t_{P2} , between any specified outputs of two devices when both devices operate with the same supply voltage, at the same temperature, and have identical packages and test circuits.
- (4) Δt_{skew} is the magnitude of the difference in differential skew t_{skew1} between any specified outputs of a single device.

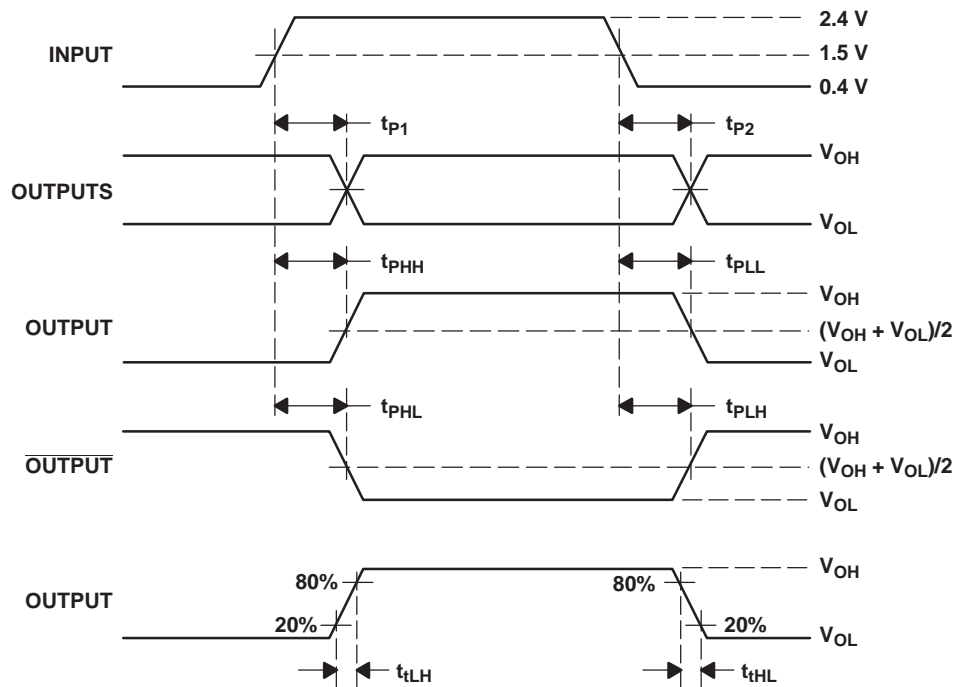
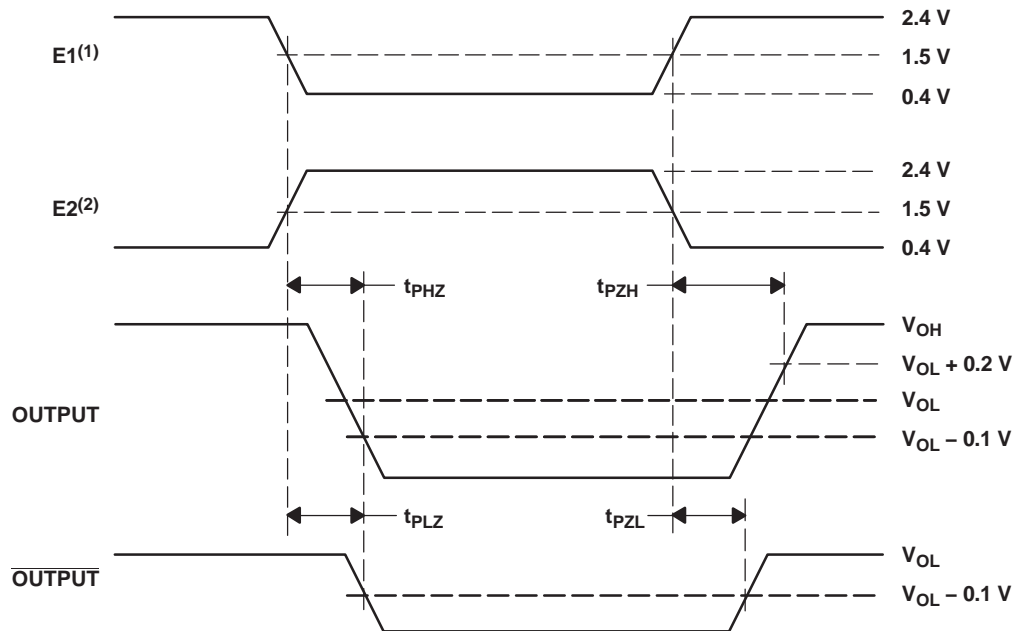

Figure 1. Propagation Delay Time Waveforms



(1) E2 = 1 while E1 changes state

(2) E1 = 0 while E2 changes state

NOTE: In the third state, both outputs (OUTPUT and $\overline{\text{OUTPUT}}$) are 0.1 V (max).

Figure 2. Enable and Disable Delay Time Waveforms

TEST CONDITIONS

Parametric values specified under the Electrical Characteristics and Switching Characteristics sections are measured with the following output load circuit.

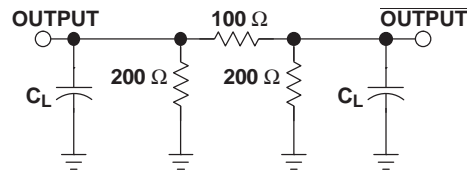

Figure 3. Driver Test Circuits, 5-V Nominal Supplies

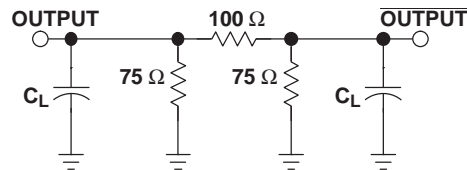
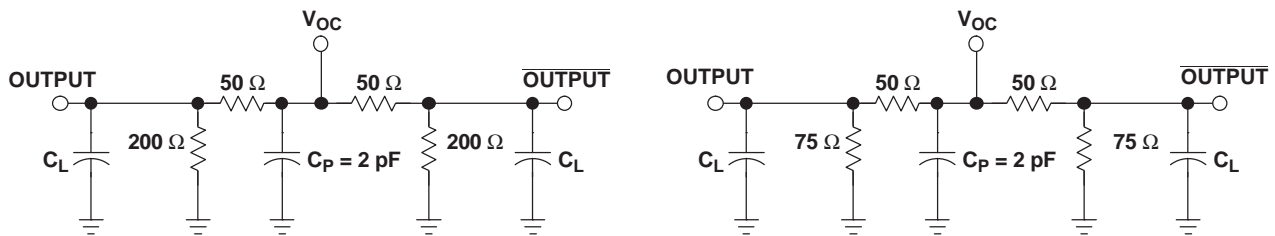
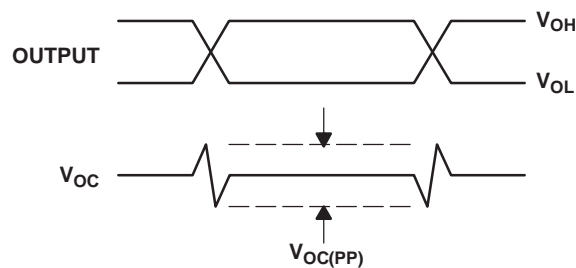

Figure 4. Driver Test Circuits, 3.3-V Nominal Supplies



Note: $V_{OC(PP)}$ load circuit for 5-V nominal supplies.

Note: $V_{OC(PP)}$ load circuit for 3.3-V nominal supplies.



Note: All input pulses are supplied by a generator having the following characteristics: t_r or $t_f = 1$ ns, pulse repetition rate (PRR) = 0.25 Mbps, pulse width = 500 ± 10 ns. C_p includes the instrumentation and fixture capacitance within 0,06 m of the D.U.T. The measurement of $V_{OC(PP)}$ is made on test equipment with a -3 dB bandwidth of at least 1 GHz.

Figure 5. Test Circuits and Definitions for the Driver Common-Mode Output Voltage

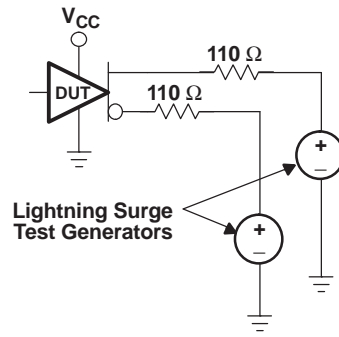

Note: Surges may be applied simultaneously, but never in opposite polarities. Surge test pulses have $t_r = t_f = 2 \mu\text{s}$, pulse width = $7 \mu\text{s}$ (50% points), and period = 250 ms.

Figure 6. Lightning-Surge Testing Configuration for TB5D1M

TYPICAL CHARACTERISTICS

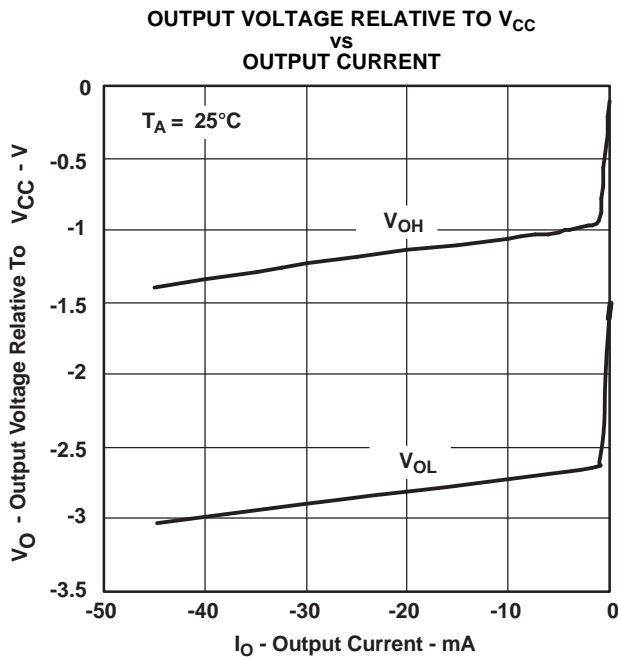

Figure 7.

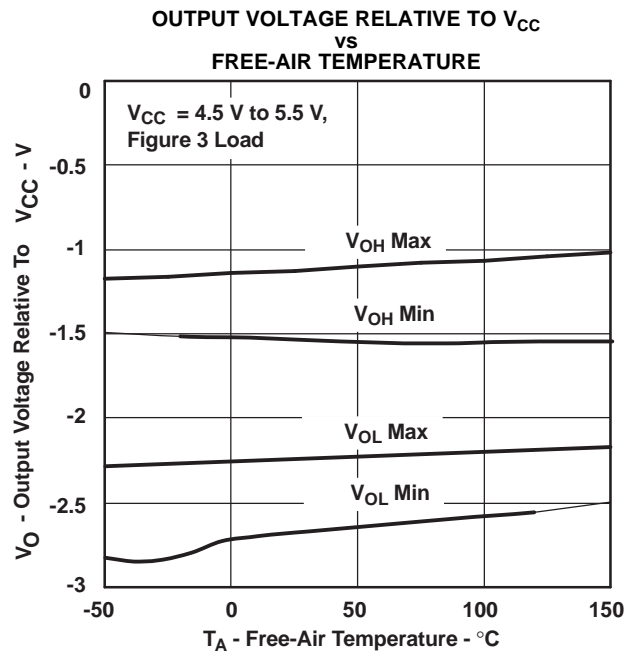

Figure 8.

TYPICAL CHARACTERISTICS (continued)

OUTPUT VOLTAGE RELATIVE TO V_{CC}
vs
FREE-AIR TEMPERATURE

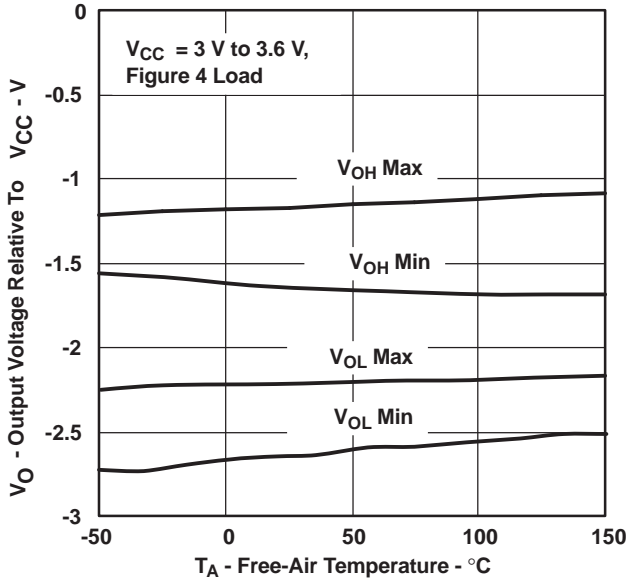

Figure 9.

DIFFERENTIAL OUTPUT VOLTAGE
vs
FREE-AIR TEMPERATURE

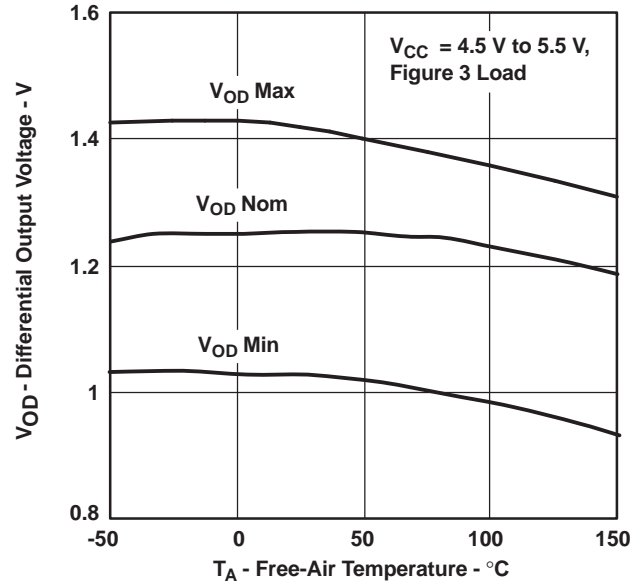

Figure 10.

DIFFERENTIAL OUTPUT VOLTAGE
vs
FREE-AIR TEMPERATURE

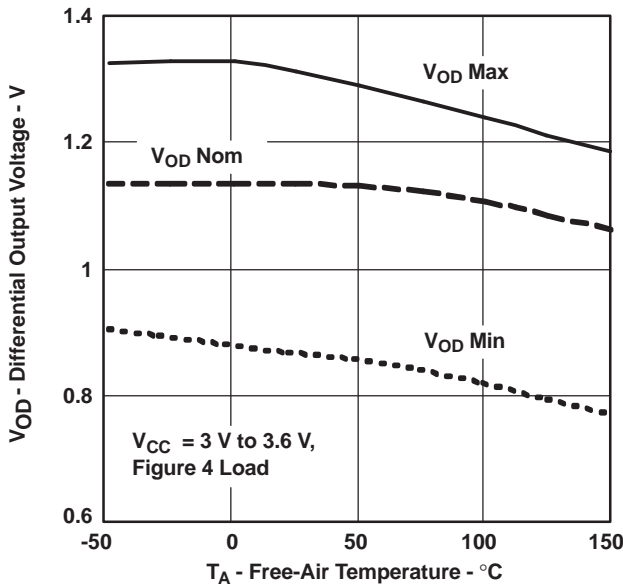

Figure 11.

PROPAGATION DELAY TIME t_{p1} or t_{p2}
vs
FREE-AIR TEMPERATURE

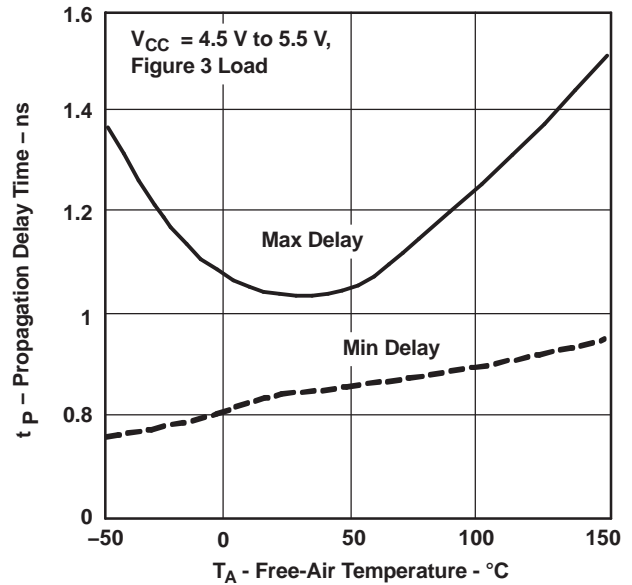
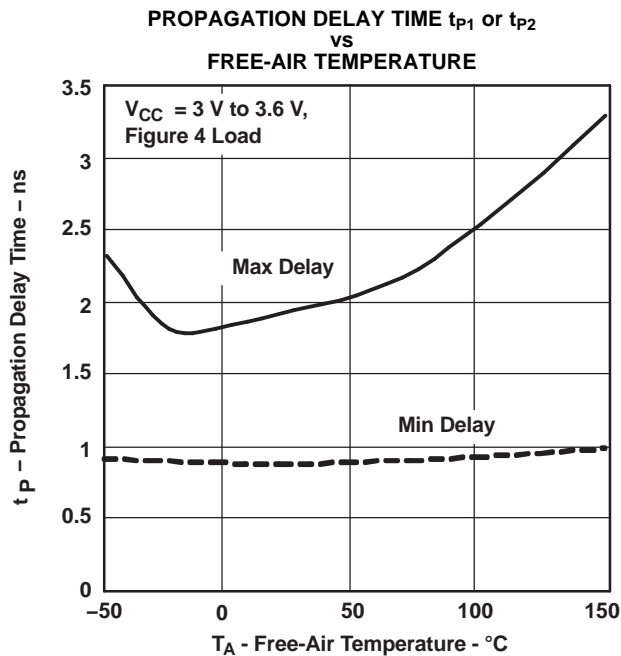

Figure 12.

TYPICAL CHARACTERISTICS (continued)



APPLICATION INFORMATION

Power Dissipation

The power dissipation rating, often listed as the package dissipation rating, is a function of the ambient temperature, T_A , and the airflow around the device. This rating correlates with the device's maximum junction temperature, sometimes listed in the absolute maximum ratings tables. The maximum junction temperature accounts for the processes and materials used to fabricate and package the device, in addition to the desired life expectancy.

There are two common approaches to estimating the internal die junction temperature, T_J . In both of these methods, the device's internal power dissipation, P_D , needs to be calculated. This is done by totaling the supply power(s) to arrive at the system power dissipation:

$$\Sigma(V_{Sn} \times I_{Sn}) \quad (1)$$

and then subtracting the total power dissipation of the external load(s):

$$\Sigma(V_{Ln} \times I_{Ln}) \quad (2)$$

The first T_J calculation uses the power dissipation and ambient temperature, along with one parameter: θ_{JA} , the junction-to-ambient thermal resistance, in degrees Celsius per watt.

The product of P_D and θ_{JA} is the junction temperature rise above the ambient temperature. Therefore:

$$T_J = T_A + (P_D \times \theta_{JA}) \quad (3)$$

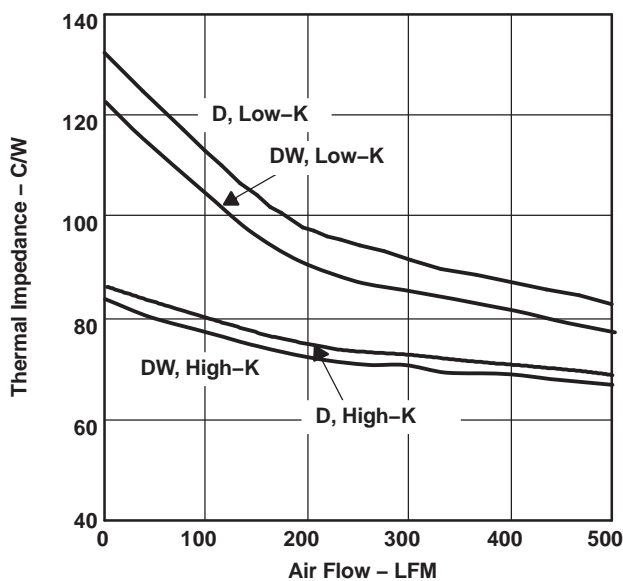

Figure 14. Thermal Impedance vs Air Flow

Note that θ_{JA} is highly dependent on the PCB on which the device is mounted, and on the airflow over

the device and PCB. JEDEC/EIA has defined standardized test conditions for measuring θ_{JA} . Two commonly used conditions are the low-K and the high-K boards, covered by EIA/JESD51-3 and EIA/JESD51-7 respectively. Figure 14 shows the low-K and high-K values of θ_{JA} versus air flow for this device and its package options.

The standardized θ_{JA} values may not accurately represent the conditions under which the device is used. This can be due to adjacent devices acting as heat sources or heat sinks, to nonuniform airflow, or to the system PCB having significantly different thermal characteristics than the standardized test PCBs. The second method of system thermal analysis is more accurate. This calculation uses the power dissipation and ambient temperature, along with two device and two system-level parameters:

- θ_{JC} , the junction-to-case thermal resistance, in degrees Celsius per watt
- θ_{JB} , the junction-to-board thermal resistance, in degrees Celsius per watt
- θ_{CA} , the case-to-ambient thermal resistance, in degrees Celsius per watt
- θ_{BA} , the board-to-ambient thermal resistance, in degrees Celsius per watt.

In this analysis, there are two parallel paths, one through the case (package) to the ambient, and another through the device to the PCB to the ambient. The system-level junction-to-ambient thermal impedance, $\theta_{JA(S)}$, is the equivalent parallel impedance of the two parallel paths:

$$T_J = T_A + (P_D \times \theta_{JA(S)}) \quad (4)$$

where

$$\theta_{JA(S)} = \frac{(\theta_{JC} + \theta_{CA}) \times (\theta_{JB} + \theta_{BA})}{(\theta_{JC} + \theta_{CA} + \theta_{JB} + \theta_{BA})}$$

The device parameters θ_{JC} and θ_{JB} account for the internal structure of the device. The system-level parameters θ_{CA} and θ_{BA} take into account details of the PCB construction, adjacent electrical and mechanical components, and the environmental conditions including airflow. Finite element (FE), finite difference (FD), or computational fluid dynamics (CFD) programs can determine θ_{CA} and θ_{BA} . Details on using these programs are beyond the scope of this data sheet, but are available from the software manufacturers.

Load Circuits

The test load circuits shown in [Figure 3](#) and [Figure 4](#) are based on a recommended *pi* type of load circuit shown in [Figure 15](#). The 100- Ω differential load resistor R_T at the receiver provide proper termination for the interconnecting transmission line, assuming it has a 100- Ω characteristic impedance. The two resistors R_S to ground at the driver end of the transmission line link provide dc current paths for the emitter follower output transistors. The two resistors to ground normally should not be placed at the receiver end, as they shunt the termination resistor, potentially creating an impedance mismatch with undesirable reflections.

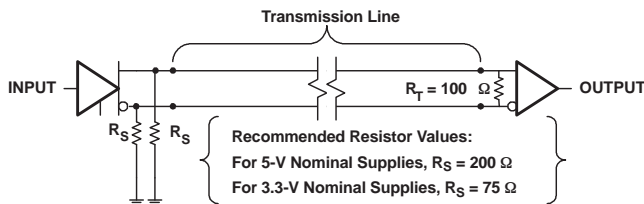

Figure 15. A Recommended *pi* Load Circuit

Another common load circuit, a Y load, is shown in [Figure 16](#). The receiver-end line termination of R_T is provided by the series combination of the two $R_T/2$ resistors, while the dc current path to ground is provided by the single resistor R_S . Recommended values, as a function of the nominal supply voltage range, are indicated in the figure.

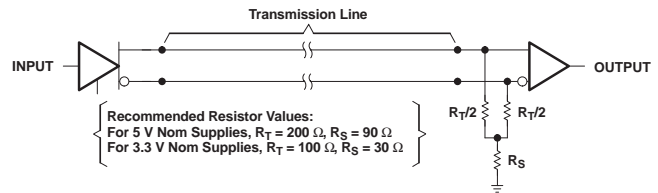

Figure 16. A Recommended Y Load Circuit

An additional load circuit, similar to one commonly used with ECL and PECL, is shown in [Figure 17](#).

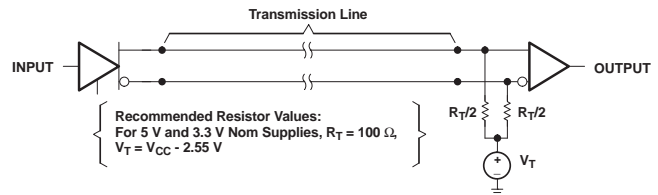

Figure 17. A Recommended PECL-Style Load Circuit

An important feature of all of these recommended load circuits is that they ensure that both of the emitter follower output transistors remain active (conducting current) at all times. When deviating from these recommended values, it is important to make sure that the low-side output transistor does not turn off. Failure to do so increases the t_{skew2} and $V_{OC(PP)}$ values, increasing the potential for electromagnetic radiation.

PACKAGING INFORMATION

Orderable Device	Status (1)	Package Type	Package Drawing	Pins	Package Qty	Eco Plan (2)	Lead/Ball Finish (6)	MSL Peak Temp (3)	Op Temp (°C)	Device Marking (4/5)	Samples
TB5D1MD	ACTIVE	SOIC	D	16	40	Pb-Free (RoHS)	CU NIPDAU	Level-2-250C-1YEAR/ Level-1-220C-UNLIM	-40 to 85	TB5D1M	Samples
TB5D1MDE4	ACTIVE	SOIC	D	16	40	Pb-Free (RoHS)	CU NIPDAU	Level-2-250C-1YEAR/ Level-1-220C-UNLIM	-40 to 85	TB5D1M	Samples
TB5D1MDW	ACTIVE	SOIC	DW	16	40	Pb-Free (RoHS)	CU NIPDAU	Level-2-250C-1YEAR/ Level-1-220C-UNLIM	-40 to 85	TB5D1M	Samples
TB5D1MDWR	ACTIVE	SOIC	DW	16	2000	Pb-Free (RoHS)	CU NIPDAU	Level-2-250C-1YEAR/ Level-1-220C-UNLIM	-40 to 85	TB5D1M	Samples
TB5D2HD	ACTIVE	SOIC	D	16	40	Pb-Free (RoHS)	CU NIPDAU	Level-2-250C-1YEAR/ Level-1-220C-UNLIM	-40 to 85	TB5D2H	Samples
TB5D2HDR	ACTIVE	SOIC	D	16	2500	Pb-Free (RoHS)	CU NIPDAU	Level-2-250C-1YEAR/ Level-1-220C-UNLIM	-40 to 85	TB5D2H	Samples
TB5D2HDW	ACTIVE	SOIC	DW	16	40	Pb-Free (RoHS)	CU NIPDAU	Level-2-250C-1YEAR/ Level-1-220C-UNLIM	-40 to 85	TB5D2H	Samples
TB5D2HDWR	ACTIVE	SOIC	DW	16	2000	Pb-Free (RoHS)	CU NIPDAU	Level-2-250C-1YEAR/ Level-1-220C-UNLIM	-40 to 85	TB5D2H	Samples

(1) The marketing status values are defined as follows:

ACTIVE: Product device recommended for new designs.

LIFEBUY: TI has announced that the device will be discontinued, and a lifetime-buy period is in effect.

NRND: Not recommended for new designs. Device is in production to support existing customers, but TI does not recommend using this part in a new design.

PREVIEW: Device has been announced but is not in production. Samples may or may not be available.

OBSOLETE: TI has discontinued the production of the device.

(2) Eco Plan - The planned eco-friendly classification: Pb-Free (RoHS), Pb-Free (RoHS Exempt), or Green (RoHS & no Sb/Br) - please check <http://www.ti.com/productcontent> for the latest availability information and additional product content details.

TBD: The Pb-Free/Green conversion plan has not been defined.

Pb-Free (RoHS): TI's terms "Lead-Free" or "Pb-Free" mean semiconductor products that are compatible with the current RoHS requirements for all 6 substances, including the requirement that lead not exceed 0.1% by weight in homogeneous materials. Where designed to be soldered at high temperatures, TI Pb-Free products are suitable for use in specified lead-free processes.

Pb-Free (RoHS Exempt): This component has a RoHS exemption for either 1) lead-based flip-chip solder bumps used between the die and package, or 2) lead-based die adhesive used between the die and leadframe. The component is otherwise considered Pb-Free (RoHS compatible) as defined above.

Green (RoHS & no Sb/Br): TI defines "Green" to mean Pb-Free (RoHS compatible), and free of Bromine (Br) and Antimony (Sb) based flame retardants (Br or Sb do not exceed 0.1% by weight in homogeneous material)

(3) MSL, Peak Temp. - The Moisture Sensitivity Level rating according to the JEDEC industry standard classifications, and peak solder temperature.

(4) There may be additional marking, which relates to the logo, the lot trace code information, or the environmental category on the device.

(5) Multiple Device Markings will be inside parentheses. Only one Device Marking contained in parentheses and separated by a "~" will appear on a device. If a line is indented then it is a continuation of the previous line and the two combined represent the entire Device Marking for that device.

(6) Lead/Ball Finish - Orderable Devices may have multiple material finish options. Finish options are separated by a vertical ruled line. Lead/Ball Finish values may wrap to two lines if the finish value exceeds the maximum column width.

Important Information and Disclaimer:The information provided on this page represents TI's knowledge and belief as of the date that it is provided. TI bases its knowledge and belief on information provided by third parties, and makes no representation or warranty as to the accuracy of such information. Efforts are underway to better integrate information from third parties. TI has taken and continues to take reasonable steps to provide representative and accurate information but may not have conducted destructive testing or chemical analysis on incoming materials and chemicals. TI and TI suppliers consider certain information to be proprietary, and thus CAS numbers and other limited information may not be available for release.

In no event shall TI's liability arising out of such information exceed the total purchase price of the TI part(s) at issue in this document sold by TI to Customer on an annual basis.

TAPE AND REEL INFORMATION

REEL DIMENSIONS



TAPE DIMENSIONS



A0	Dimension designed to accommodate the component width
B0	Dimension designed to accommodate the component length
K0	Dimension designed to accommodate the component thickness
W	Overall width of the carrier tape
P1	Pitch between successive cavity centers

TAPE AND REEL INFORMATION

*All dimensions are nominal

Device	Package Type	Package Drawing	Pins	SPQ	Reel Diameter (mm)	Reel Width W1 (mm)	A0 (mm)	B0 (mm)	K0 (mm)	P1 (mm)	W (mm)	Pin1 Quadrant
TB5D1MDWR	SOIC	DW	16	2000	330.0	16.4	10.75	10.7	2.7	12.0	16.0	Q1
TB5D2HDR	SOIC	D	16	2500	330.0	16.4	6.5	10.3	2.1	8.0	16.0	Q1
TB5D2HDWR	SOIC	DW	16	2000	330.0	16.4	10.75	10.7	2.7	12.0	16.0	Q1

TAPE AND REEL BOX DIMENSIONS

*All dimensions are nominal

Device	Package Type	Package Drawing	Pins	SPQ	Length (mm)	Width (mm)	Height (mm)
TB5D1MDWR	SOIC	DW	16	2000	367.0	367.0	38.0
TB5D2HDR	SOIC	D	16	2500	367.0	367.0	38.0
TB5D2HDWR	SOIC	DW	16	2000	367.0	367.0	38.0

D (R-PDSO-G16)

PLASTIC SMALL OUTLINE



4040047-6/M 06/11

- NOTES:
- A. All linear dimensions are in inches (millimeters).
 - B. This drawing is subject to change without notice.
 -  C. Body length does not include mold flash, protrusions, or gate burrs. Mold flash, protrusions, or gate burrs shall not exceed 0.006 (0,15) each side.
 -  D. Body width does not include interlead flash. Interlead flash shall not exceed 0.017 (0,43) each side.
 - E. Reference JEDEC MS-012 variation AC.

D (R-PDSO-G16)

PLASTIC SMALL OUTLINE



- NOTES:
- A. All linear dimensions are in millimeters.
 - B. This drawing is subject to change without notice.
 - C. Publication IPC-7351 is recommended for alternate designs.
 - D. Laser cutting apertures with trapezoidal walls and also rounding corners will offer better paste release. Customers should contact their board assembly site for stencil design recommendations. Refer to IPC-7525 for other stencil recommendations.
 - E. Customers should contact their board fabrication site for solder mask tolerances between and around signal pads.

DW (R-PDSO-G16)

PLASTIC SMALL OUTLINE



- NOTES:
- All linear dimensions are in inches (millimeters). Dimensioning and tolerancing per ASME Y14.5M-1994.
 - This drawing is subject to change without notice.
 - Body dimensions do not include mold flash or protrusion not to exceed 0.006 (0,15).
 - Falls within JEDEC MS-013 variation AA.

DW (R-PDSO-G16)

PLASTIC SMALL OUTLINE

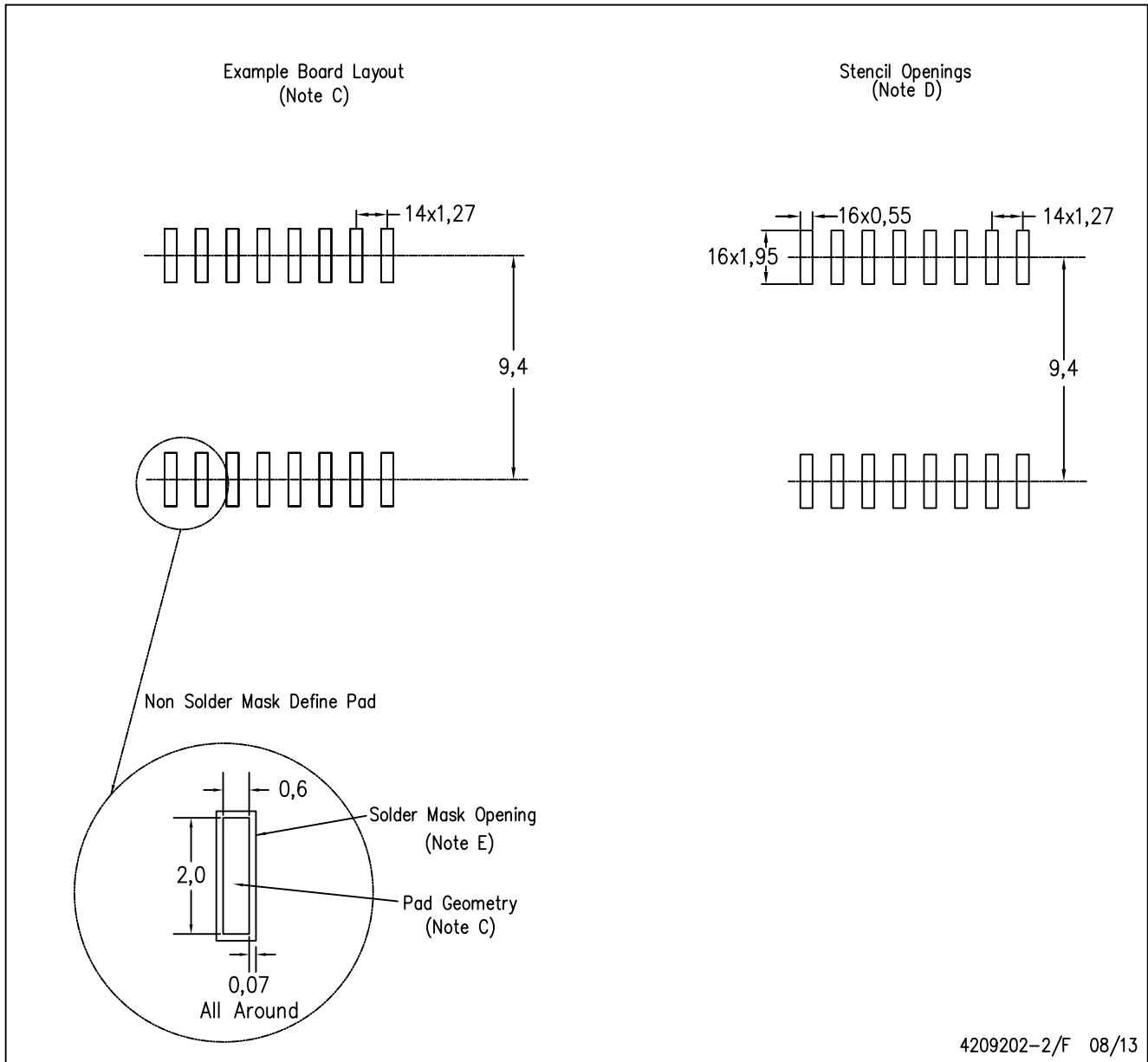

- NOTES:
- A. All linear dimensions are in millimeters.
 - B. This drawing is subject to change without notice.
 - C. Refer to IPC7351 for alternate board design.
 - D. Laser cutting apertures with trapezoidal walls and also rounding corners will offer better paste release. Customers should contact their board assembly site for stencil design recommendations. Refer to IPC-7525
 - E. Customers should contact their board fabrication site for solder mask tolerances between and around signal pads.

IMPORTANT NOTICE

Texas Instruments Incorporated and its subsidiaries (TI) reserve the right to make corrections, enhancements, improvements and other changes to its semiconductor products and services per JESD46, latest issue, and to discontinue any product or service per JESD48, latest issue. Buyers should obtain the latest relevant information before placing orders and should verify that such information is current and complete. All semiconductor products (also referred to herein as "components") are sold subject to TI's terms and conditions of sale supplied at the time of order acknowledgment.

TI warrants performance of its components to the specifications applicable at the time of sale, in accordance with the warranty in TI's terms and conditions of sale of semiconductor products. Testing and other quality control techniques are used to the extent TI deems necessary to support this warranty. Except where mandated by applicable law, testing of all parameters of each component is not necessarily performed.

TI assumes no liability for applications assistance or the design of Buyers' products. Buyers are responsible for their products and applications using TI components. To minimize the risks associated with Buyers' products and applications, Buyers should provide adequate design and operating safeguards.

TI does not warrant or represent that any license, either express or implied, is granted under any patent right, copyright, mask work right, or other intellectual property right relating to any combination, machine, or process in which TI components or services are used. Information published by TI regarding third-party products or services does not constitute a license to use such products or services or a warranty or endorsement thereof. Use of such information may require a license from a third party under the patents or other intellectual property of the third party, or a license from TI under the patents or other intellectual property of TI.

Reproduction of significant portions of TI information in TI data books or data sheets is permissible only if reproduction is without alteration and is accompanied by all associated warranties, conditions, limitations, and notices. TI is not responsible or liable for such altered documentation. Information of third parties may be subject to additional restrictions.

Resale of TI components or services with statements different from or beyond the parameters stated by TI for that component or service voids all express and any implied warranties for the associated TI component or service and is an unfair and deceptive business practice. TI is not responsible or liable for any such statements.

Buyer acknowledges and agrees that it is solely responsible for compliance with all legal, regulatory and safety-related requirements concerning its products, and any use of TI components in its applications, notwithstanding any applications-related information or support that may be provided by TI. Buyer represents and agrees that it has all the necessary expertise to create and implement safeguards which anticipate dangerous consequences of failures, monitor failures and their consequences, lessen the likelihood of failures that might cause harm and take appropriate remedial actions. Buyer will fully indemnify TI and its representatives against any damages arising out of the use of any TI components in safety-critical applications.

In some cases, TI components may be promoted specifically to facilitate safety-related applications. With such components, TI's goal is to help enable customers to design and create their own end-product solutions that meet applicable functional safety standards and requirements. Nonetheless, such components are subject to these terms.

No TI components are authorized for use in FDA Class III (or similar life-critical medical equipment) unless authorized officers of the parties have executed a special agreement specifically governing such use.

Only those TI components which TI has specifically designated as military grade or "enhanced plastic" are designed and intended for use in military/aerospace applications or environments. Buyer acknowledges and agrees that any military or aerospace use of TI components which have **not** been so designated is solely at the Buyer's risk, and that Buyer is solely responsible for compliance with all legal and regulatory requirements in connection with such use.

TI has specifically designated certain components as meeting ISO/TS16949 requirements, mainly for automotive use. In any case of use of non-designated products, TI will not be responsible for any failure to meet ISO/TS16949.

Products

Audio	www.ti.com/audio
Amplifiers	amplifier.ti.com
Data Converters	dataconverter.ti.com
DLP® Products	www.dlp.com
DSP	dsp.ti.com
Clocks and Timers	www.ti.com/clocks
Interface	interface.ti.com
Logic	logic.ti.com
Power Mgmt	power.ti.com
Microcontrollers	microcontroller.ti.com
RFID	www.ti-rfid.com
OMAP Applications Processors	www.ti.com/omap
Wireless Connectivity	www.ti.com/wirelessconnectivity

Applications

Automotive and Transportation	www.ti.com/automotive
Communications and Telecom	www.ti.com/communications
Computers and Peripherals	www.ti.com/computers
Consumer Electronics	www.ti.com/consumer-apps
Energy and Lighting	www.ti.com/energy
Industrial	www.ti.com/industrial
Medical	www.ti.com/medical
Security	www.ti.com/security
Space, Avionics and Defense	www.ti.com/space-avionics-defense
Video and Imaging	www.ti.com/video

TI E2E Community

e2e.ti.com