

TLE208x, TLE208xA, TLE208xY EXCALIBUR HIGH-SPEED JFET-INPUT OPERATIONAL AMPLIFIERS

SLOS182B – FEBRUARY 1997 – REVISED JUNE 2001

- Direct Upgrades to TL05x, TL07x, and TL08x BiFET Operational Amplifiers
- Greater Than 2× Bandwidth (10 MHz) and 3× Slew Rate (45 V/μs) Than TL08x
- On-Chip Offset Voltage Trimming for Improved DC Performance
- Wider Supply Rails Increase Dynamic Signal Range to ±19 V

description

The TLE208x series of JFET-input operational amplifiers more than double the bandwidth and triple the slew rate of the TL07x and TL08x families of BiFET operational amplifiers. The TLE208x also have wider supply-voltage rails, increasing the dynamic-signal range for BiFET circuits to ±19 V. On-chip zener trimming of offset voltage yields precision grades for greater accuracy in dc-coupled applications. The TLE208x are pin-compatible with lower performance BiFET operational amplifiers for ease in improving performance in existing designs.

BiFET operational amplifiers offer the inherently higher input impedance of the JFET-input transistors, without sacrificing the output drive associated with bipolar amplifiers. This makes these amplifiers better suited for interfacing with high-impedance sensors or very low level ac signals. They also feature inherently better ac response than bipolar or CMOS devices having comparable power consumption.

Because BiFET operational amplifiers are designed for use with dual power supplies, care must be taken to observe common-mode input-voltage limits and output voltage swing when operating from a single supply. DC biasing of the input signal is required and loads should be terminated to a virtual ground node at mid-supply. Texas Instruments TLE2426 integrated virtual ground generator is useful when operating BiFET amplifiers from single supplies.

The TLE208x are fully specified at ±15 V and ±5 V. For operation in low-voltage and/or single-supply systems, Texas Instruments LinCMOS™ families of operational amplifiers (TLC- and TLV-prefix) are recommended. When moving from BiFET to CMOS amplifiers, particular attention should be paid to slew rate and bandwidth requirements and output loading.

For BiFET circuits requiring low noise and/or tighter dc precision, the TLE207x offer the same ac response as the TLE208x with more stringent dc and noise specifications.



Please be aware that an important notice concerning availability, standard warranty, and use in critical applications of Texas Instruments semiconductor products and disclaimers thereto appears at the end of this data sheet.

LinCMOS is a trademark of Texas Instruments.

PRODUCTION DATA information is current as of publication date. Products conform to specifications per the terms of Texas Instruments standard warranty. Production processing does not necessarily include testing of all parameters.



POST OFFICE BOX 655303 • DALLAS, TEXAS 75265

Copyright © 2001, Texas Instruments Incorporated

TLE208x, TLE208xA, TLE208xY EXCALIBUR HIGH-SPEED JFET-INPUT OPERATIONAL AMPLIFIERS

SLOS182B – FEBRUARY 1997 – REVISED JUNE 2001

TLE2081 AVAILABLE OPTIONS

| T _A | V _{IOmax} AT 25°C | PACKAGED DEVICES | | | | CHIP FORM (Y) |
|----------------|-------------------------------|-------------------------|---------------------------|---------------------------|-------------------------|---------------------|
| | | SMALL OUTLINE (D) | CHIP CARRIER (FK) | CERAMIC DIP (JG) | PLASTIC DIP (P) | |
| 0°C to 70°C | 3 mV 6 mV | TLE2081ACD TLE2081CD | — | — | TLE2081ACP TLE2081CP | — TLE2081Y |
| –40°C to 85°C | 3 mV 6 mV | TLE2081AID TLE2081ID | — | — | TLE2081AIP TLE2081IP | — |
| –55°C to 125°C | 3 mV 6 mV | — | TLE2081AMFK TLE2081MFK | TLE2081AMJG TLE2081MJG | — | — |

† The D packages are available taped and reeled. Add R suffix to device type (e.g., TLE2081ACDR).

‡ Chip forms are tested at T_A = 25°C only.

TLE2082 AVAILABLE OPTIONS

| T _A | V _{IOmax} AT 25°C | PACKAGED DEVICES | | | | CHIP FORM (Y) |
|----------------|-------------------------------|-------------------------|---------------------------|---------------------------|-------------------------|------------------|
| | | SMALL OUTLINE (D) | CHIP CARRIER (FK) | CERAMIC DIP (JG) | PLASTIC DIP (P) | |
| 0°C to 70°C | 4 mV 7 mV | TLE2082ACD TLE2082CD | — | — | TLE2082ACP TLE2082CP | — |
| –40°C to 85°C | 4 mV 7 mV | TLE2082AID TLE2082ID | — | — | TLE2082AIP TLE2082IP | TLE2082Y |
| –55°C to 125°C | 4 mV 7 mV | TLE2082AMD TLE2082MD | TLE2082AMFK TLE2082MFK | TLE2082AMJG TLE2082MJG | TLE2082AMP TLE2082MP | — |

† The D packages are available taped and reeled. Add R suffix to device type (e.g., TLE2082ACDR).

‡ Chip forms are tested at T_A = 25°C only.

TLE2084 AVAILABLE OPTIONS

| T _A | V _{IOmax} AT 25°C | PACKAGED DEVICES | | | | CHIP FORM (Y) |
|----------------|-------------------------------|---------------------------|---------------------------|-------------------------|-------------------------|---------------------|
| | | SMALL OUTLINE (DW) | CHIP CARRIER (FK) | CERAMIC DIP (J) | PLASTIC DIP (N) | |
| 0°C to 70°C | 4 mV 7 mV | TLE2084ACDW TLE2084CDW | — | — | TLE2084ACN TLE2084CN | — TLE2084Y |
| –55°C to 125°C | 4 mV 7 mV | — | TLE2084AMFK TLE2084MFK | TLE2084AMJ TLE2084MJ | — | — |

† The DW packages are available taped and reeled. Add R suffix to device type (e.g., TLE2084ACDWR).

‡ Chip forms are tested at T_A = 25°C only.



TLE208x, TLE208xA, TLE208xY EXCALIBUR HIGH-SPEED JFET-INPUT OPERATIONAL AMPLIFIERS

SLOS182B – FEBRUARY 1997 – REVISED JUNE 2001

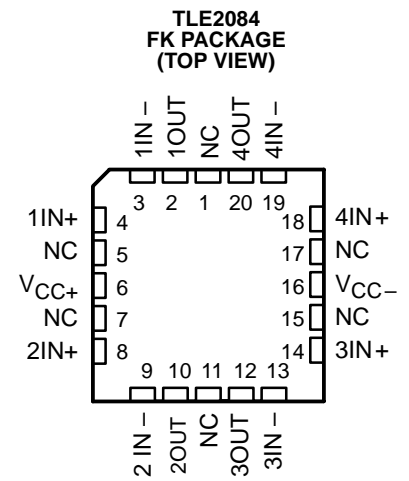
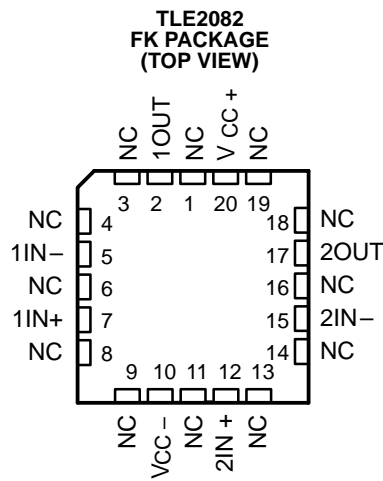
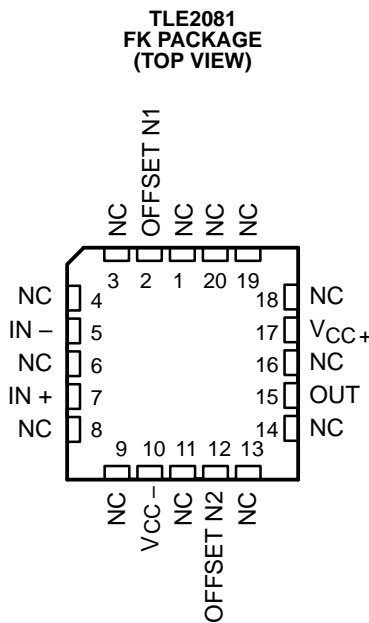
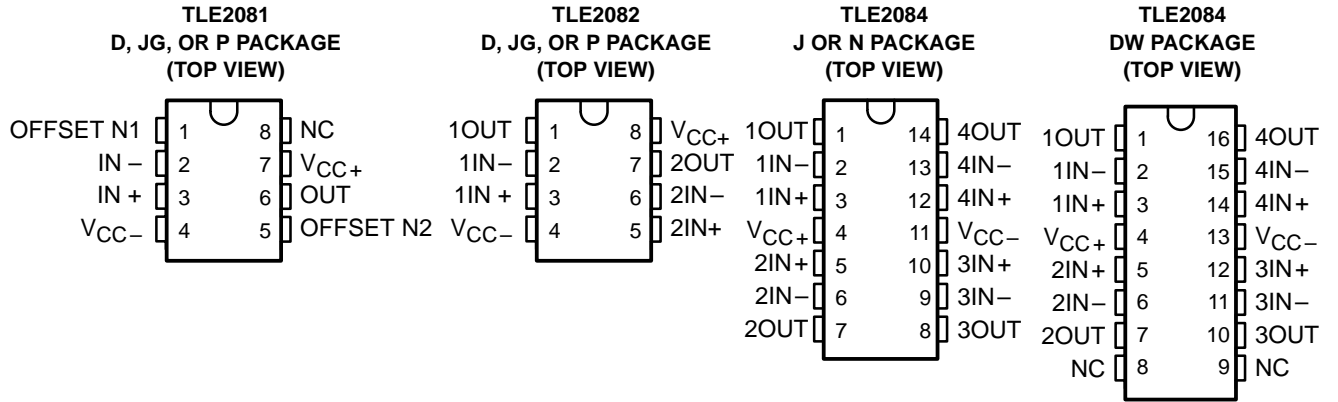

NC – No internal connection

symbol

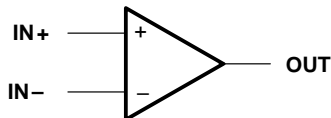

TLE208x, TLE208xA, TLE208xY EXCALIBUR HIGH-SPEED JFET-INPUT OPERATIONAL AMPLIFIERS

SLOS182B – FEBRUARY 1997 – REVISED JUNE 2001

TLE2081Y chip information

This chip, when properly assembled, displays characteristics similar to the TLE2081. Thermal compression or ultrasonic bonding may be used on the doped-aluminum bonding pads. Chips may be mounted with conductive epoxy or a gold-silicon preform.

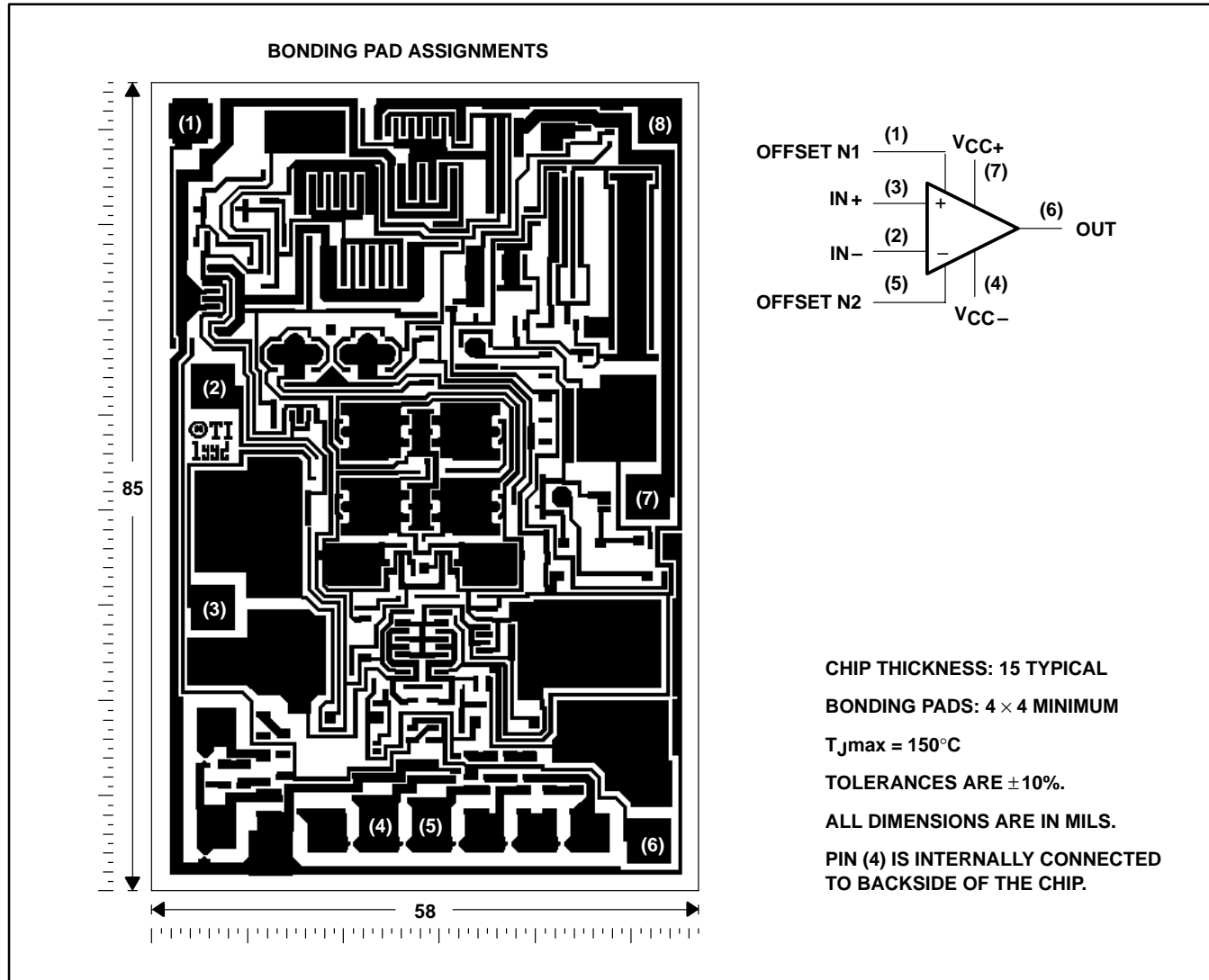

TLE208x, TLE208xA, TLE208xY EXCALIBUR HIGH-SPEED JFET-INPUT OPERATIONAL AMPLIFIERS

SLOS182B – FEBRUARY 1997 – REVISED JUNE 2001

TLE2082Y chip information

This chip, when properly assembled, displays characteristics similar to the TLE2082. Thermal compression or ultrasonic bonding may be used on the doped-aluminum bonding pads. Chips may be mounted with conductive epoxy or a gold-silicon preform.

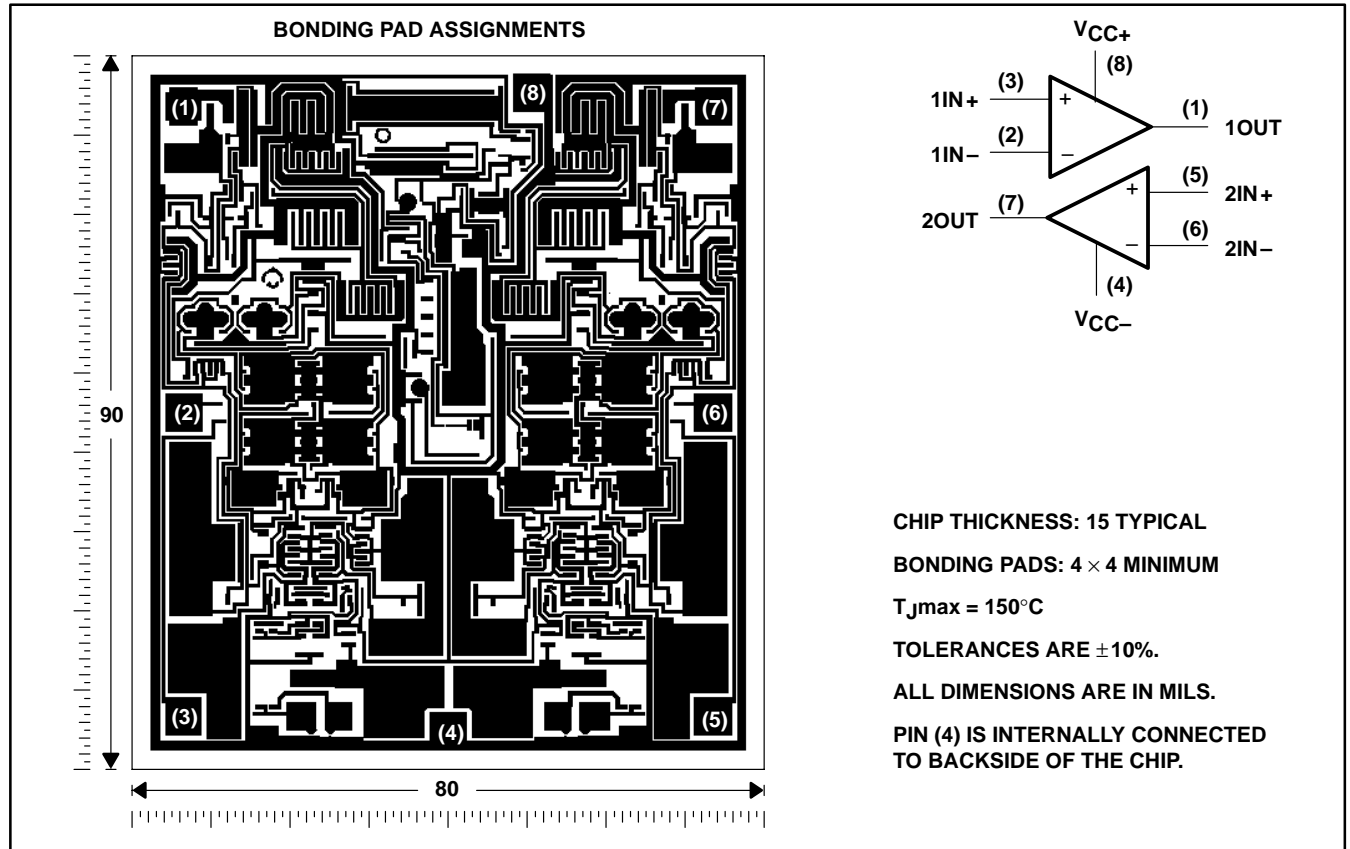

TLE208x, TLE208xA, TLE208xY EXCALIBUR HIGH-SPEED JFET-INPUT OPERATIONAL AMPLIFIERS

SLOS182B – FEBRUARY 1997 – REVISED JUNE 2001

TLE2084Y chip information

This chip, when properly assembled, displays characteristics similar to the TLE2084. Thermal compression or ultrasonic bonding may be used on the doped-aluminum bonding pads. Chips may be mounted with conductive epoxy or a gold-silicon preform.

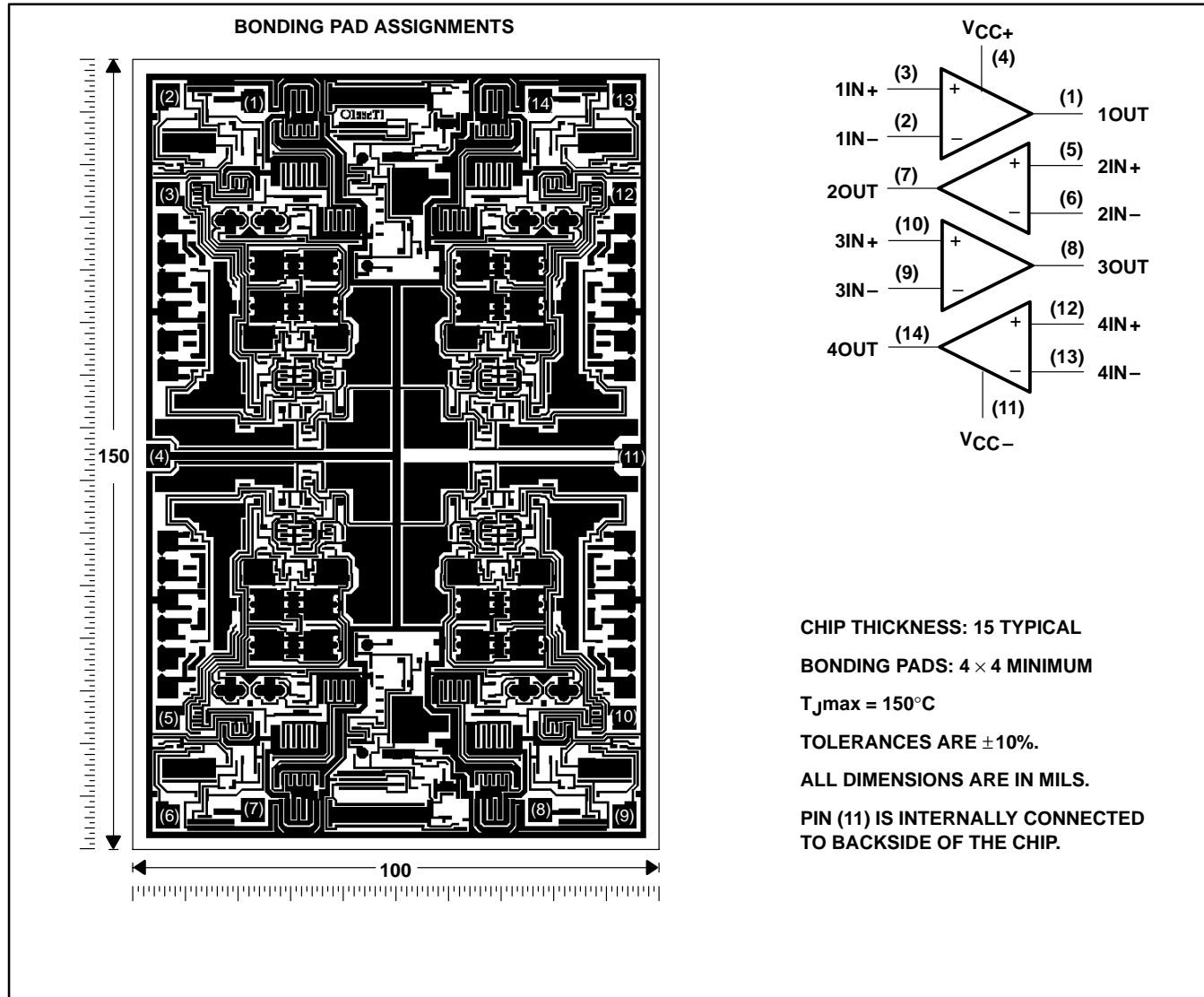

equivalent schematic (each channel)

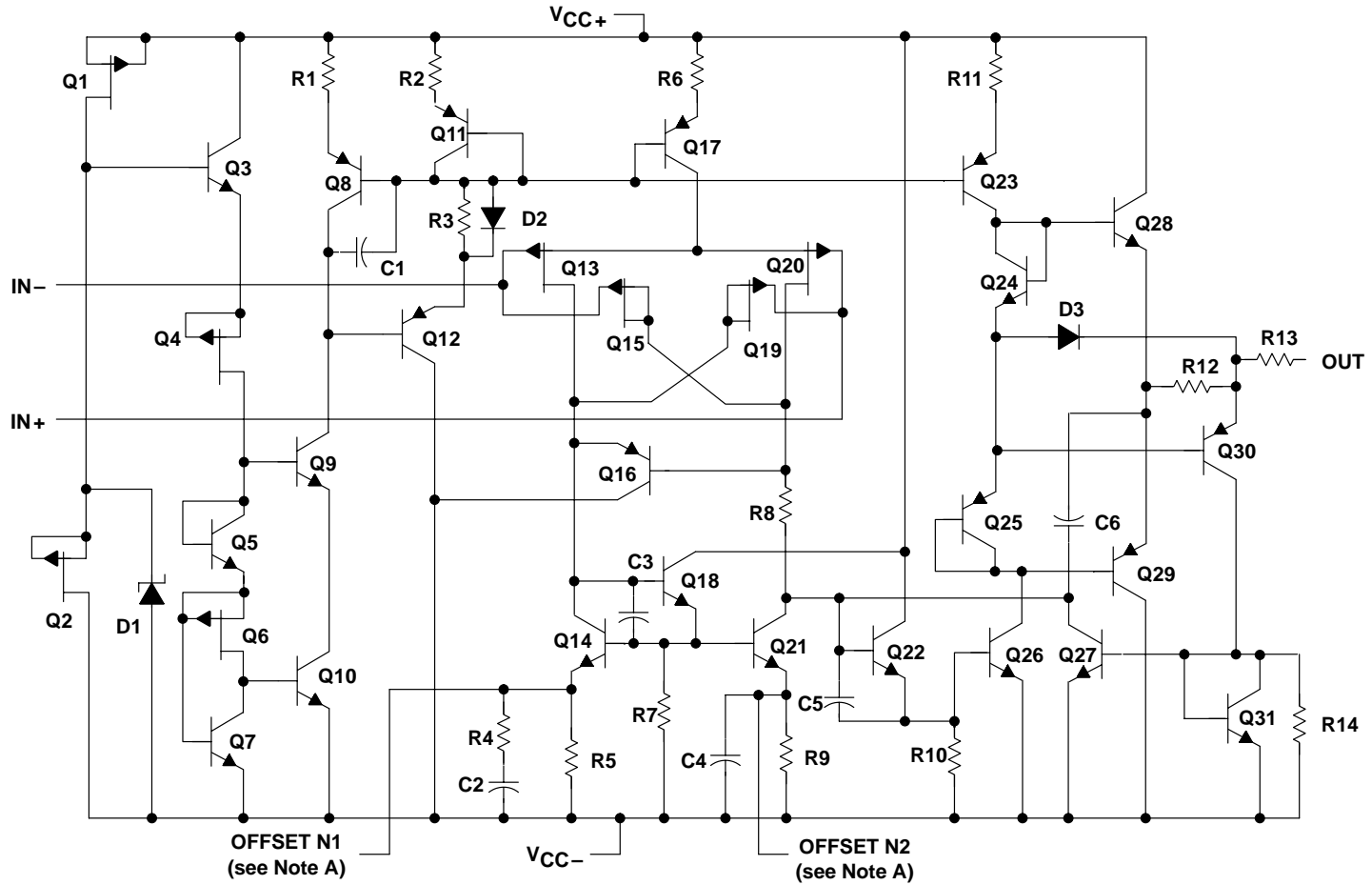

NOTE A: OFFSET N1 and OFFSET N2 are only available on the TLE2081x devices.

| ACTUAL DEVICE COMPONENT COUNT | | | |
|-------------------------------|---------|---------|---------|
| COMPONENT | TLE2081 | TLE2082 | TLE2084 |
| Transistors | 33 | 57 | 114 |
| Resistors | 25 | 37 | 74 |
| Diodes | 8 | 5 | 10 |
| Capacitors | 6 | 11 | 22 |

TLE208x, TLE208xA, TLE208xY EXCALIBUR HIGH-SPEED JFET-INPUT OPERATIONAL AMPLIFIERS

SLOS182B – FEBRUARY 1997 – REVISED JUNE 2001

absolute maximum ratings over operating free-air temperature range (unless otherwise noted)†

| | |
|---|------------------------------|
| Supply voltage, V_{CC+} (see Note 1) | 19 V |
| Supply voltage, V_{CC-} (see Note 1) | -19 V |
| Differential input voltage range, V_{ID} (see Note 2) | V_{CC+} to V_{CC-} |
| Input voltage range, V_I (any input) | V_{CC+} to V_{CC-} |
| Input current, I_I (each input) | ± 1 mA |
| Output current, I_O (each output) | ± 80 mA |
| Total current into V_{CC+} | 160 mA |
| Total current out of V_{CC-} | 160 mA |
| Duration of short-circuit current at (or below) 25°C (see Note 3) | unlimited |
| Continuous total dissipation | See Dissipation Rating Table |
| Operating free-air temperature range, T_A : C suffix | 0°C to 70°C |
| I suffix | -40°C to 85°C |
| M suffix | -55°C to 125°C |
| Storage temperature range | -65°C to 150°C |
| Case temperature for 60 seconds: FK package | 260°C |
| Lead temperature 1,6 mm (1/16 inch) from case for 10 seconds: DW or N package | 260°C |
| Lead temperature 1,6 mm (1/16 inch) from case for 60 seconds: J package | 300°C |

† Stresses beyond those listed under “absolute maximum ratings” may cause permanent damage to the device. These are stress ratings only, and functional operation of the device at these or any other conditions beyond those indicated under “recommended operating conditions” is not implied. Exposure to absolute-maximum-rated conditions for extended periods may affect device reliability.

- NOTES: 1. All voltage values, except differential voltages, are with respect to the midpoint between V_{CC+} and V_{CC-} .
 2. Differential voltages are at $IN+$ with respect to $IN-$.
 3. The output can be shorted to either supply. Temperatures and/or supply voltages must be limited to ensure that the maximum dissipation rate is not exceeded.

DISSIPATION RATING TABLE

| PACKAGE | $T_A \leq 25^\circ\text{C}$ | DERATING FACTOR ABOVE $T_A = 25^\circ\text{C}$ | $T_A = 70^\circ\text{C}$ | $T_A = 85^\circ\text{C}$ | $T_A = 125^\circ\text{C}$ |
|---------|-----------------------------|---|--------------------------|--------------------------|---------------------------|
| | POWER RATING | | POWER RATING | POWER RATING | POWER RATING |
| D | 725 mW | 5.8 mW/°C | 464 mW | 377 mW | 145 mW |
| DW | 1025 mW | 8.2 mW/°C | 656 mW | 533 mW | 205 mW |
| FK | 1375 mW | 11.0 mW/°C | 880 mW | 715 mW | 275 mW |
| J | 1375 mW | 11.0 mW/°C | 880 mW | 715 mW | 275 mW |
| JG | 1050 mW | 8.4 mW/°C | 672 mW | 546 mW | 210 mW |
| N | 1150 mW | 9.2 mW/°C | 736 mW | 598 mW | 230 mW |
| P | 1000 mW | 8.0 mW/°C | 640 mW | 344 mW | 200 mW |

recommended operating conditions

| | C SUFFIX | | I SUFFIX | | M SUFFIX | | UNIT |
|---------------------------------------|------------------------|----------|------------|----------|------------|----------|------|
| | MIN | MAX | MIN | MAX | MIN | MAX | |
| Supply voltage, $V_{CC\pm}$ | ± 2.25 | ± 19 | ± 2.25 | ± 19 | ± 2.25 | ± 19 | V |
| Common-mode input voltage, V_{IC} | $V_{CC\pm} = \pm 5$ V | | -0.9 | 5 | -0.8 | 5 | V |
| | $V_{CC\pm} = \pm 15$ V | | -10.9 | 15 | -10.8 | 15 | |
| Operating free-air temperature, T_A | 0 | 70 | -40 | 85 | -55 | 125 | °C |



TLE208x, TLE208xA, TLE208xY
EXCALIBUR HIGH-SPEED JFET-INPUT
OPERATIONAL AMPLIFIERS

SLOS182B – FEBRUARY 1997 – REVISED JUNE 2001

TLE2081C electrical characteristics at specified free-air temperature, $V_{CC\pm} = \pm 5\text{ V}$ (unless otherwise noted)

| PARAMETER | TEST CONDITIONS | T_A † | TLE2081C | | | TLE2081AC | | | UNIT |
|---|--|----------------------------|-------------------------------|------------|------------|-----------|-----------|------------------------------|------|
| | | | MIN | TYP | MAX | MIN | TYP | MAX | |
| V_{IO} Input offset voltage | $V_{IC} = 0,$ $R_S = 50\ \Omega$ | $V_O = 0,$ | 25°C | 0.34 | 6 | 0.3 | 3 | mV | |
| | | | Full range | 8 | | | 5 | | |
| α_{VIO} Temperature coefficient of input offset voltage | $V_{IC} = 0,$ $R_S = 50\ \Omega$ | $V_O = 0,$ | Full range | 3.2 | 29 | 3.2 | 29 | $\mu\text{V}/^\circ\text{C}$ | |
| I_{IO} Input offset current | | | $V_{IC} = 0,$ See Figure 4 | $V_O = 0,$ | 25°C | 5 | 100 | 5 | 100 |
| I_{IB} Input bias current | $V_{IC} = 0,$ See Figure 4 | $V_O = 0,$ | | | Full range | 1.4 | | | 1.4 |
| | | | 25°C | 15 | 175 | 15 | 175 | nA | |
| V_{ICR} Common-mode input voltage range | $R_S = 50\ \Omega$ | $V_O = 0,$ | 25°C | 5 to -1 | 5 to -1.9 | 5 to -1 | 5 to -1.9 | V | |
| | | | Full range | 5 to -0.9 | | | 5 to -0.9 | | |
| V_{OM+} Maximum positive peak output voltage swing | $I_O = -200\ \mu\text{A}$ | $V_O = 0,$ | 25°C | 3.8 | 4.1 | 3.8 | 4.1 | V | |
| | | | Full range | 3.7 | | | 3.7 | | |
| | $I_O = -2\ \text{mA}$ | $V_O = 0,$ | 25°C | 3.5 | 3.9 | 3.5 | 3.9 | | |
| | | | Full range | 3.4 | | | 3.4 | | |
| | $I_O = -20\ \text{mA}$ | $V_O = 0,$ | 25°C | 1.5 | 2.3 | 1.5 | 2.3 | | |
| | | | Full range | 1.5 | | | 1.5 | | |
| V_{OM-} Maximum negative peak output voltage swing | $I_O = 200\ \mu\text{A}$ | $V_O = 0,$ | 25°C | -3.5 | -4.2 | -3.5 | -4.2 | V | |
| | | | Full range | -3.4 | | | -3.4 | | |
| | $I_O = 2\ \text{mA}$ | $V_O = 0,$ | 25°C | -3.7 | -4.1 | -3.7 | -4.1 | | |
| | | | Full range | -3.6 | | | -3.6 | | |
| | $I_O = 20\ \text{mA}$ | $V_O = 0,$ | 25°C | -1.5 | -2.4 | -1.5 | -2.4 | | |
| | | | Full range | -1.5 | | | -1.5 | | |
| A_{VD} Large-signal differential voltage amplification | $V_O = \pm 2.3\ \text{V}$ | $R_L = 600\ \Omega$ | 25°C | 80 | 91 | 80 | 91 | dB | |
| | | | Full range | 79 | | | 79 | | |
| | | $R_L = 2\ \text{k}\Omega$ | $V_O = \pm 2.3\ \text{V}$ | 25°C | 90 | 100 | 90 | | 100 |
| | | | | Full range | 89 | | | | 89 |
| | | $R_L = 10\ \text{k}\Omega$ | $V_O = \pm 2.3\ \text{V}$ | 25°C | 95 | 106 | 95 | | 106 |
| | | | | Full range | 94 | | | | 94 |
| r_i Input resistance | $V_{IC} = 0$ | $V_O = 0,$ | 25°C | 10^{12} | | 10^{12} | | Ω | |
| c_i Input capacitance | $V_{IC} = 0,$ See Figure 5 | Common mode | 25°C | 11 | | 11 | | pF | |
| | | Differential | 25°C | 2.5 | | 2.5 | | | |
| z_o Open-loop output impedance | $f = 1\ \text{MHz}$ | $V_O = 0,$ | 25°C | 80 | | 80 | | Ω | |
| CMRR Common-mode rejection ratio | $V_{IC} = V_{ICRmin},$ $V_O = 0,$ $R_S = 50\ \Omega$ | $V_O = 0,$ | 25°C | 70 | 89 | 70 | 89 | dB | |
| | | | Full range | 68 | | | 68 | | |
| k_{SVR} Supply-voltage rejection ratio ($\Delta V_{CC\pm} / \Delta V_{IO}$) | $V_{CC\pm} = \pm 5\ \text{V}$ to $\pm 15\ \text{V},$ $V_O = 0,$ $R_S = 50\ \Omega$ | $V_O = 0,$ | 25°C | 82 | 99 | 82 | 99 | dB | |
| | | | Full range | 80 | | | 80 | | |

† Full range is 0°C to 70°C.



TLE208x, TLE208xA, TLE208xY
EXCALIBUR HIGH-SPEED JFET-INPUT
OPERATIONAL AMPLIFIERS

SLOS182B – FEBRUARY 1997 – REVISED JUNE 2001

TLE2081C electrical characteristics at specified free-air temperature, $V_{CC\pm} = \pm 5\text{ V}$ (unless otherwise noted) (continued)

| PARAMETER | TEST CONDITIONS | T_A † | TLE2081C | | | TLE2081AC | | | UNIT |
|---------------------------------------|---------------------|------------|------------------------|-----|-----|-----------|-----|-----|------|
| | | | MIN | TYP | MAX | MIN | TYP | MAX | |
| I_{CC} Supply current | $V_O = 0$, No load | 25°C | 1.35 | 1.6 | 2.2 | 1.35 | 1.6 | 2.2 | mA |
| | | Full range | | | | 2.2 | | | |
| I_{OS} Short-circuit output current | $V_O = 0$ | 25°C | $V_{ID} = 1\text{ V}$ | | | -35 | | | mA |
| | | | $V_{ID} = -1\text{ V}$ | | | 45 | | | |

† Full range is 0°C to 70°C.

TLE2081C operating characteristics at specified free-air temperature, $V_{CC\pm} = \pm 5\text{ V}$

| PARAMETER | TEST CONDITIONS | T_A † | TLE2081C | | | TLE2081AC | | | UNIT | |
|---|--|--------------------------------------|---------------------|--------------------------------------|-----|-----------|------|-----|------------------------|------------------------|
| | | | MIN | TYP | MAX | MIN | TYP | MAX | | |
| SR+ Positive slew rate | $V_{O(PP)} = \pm 2.3\text{ V}$, $A_{VD} = -1$, $R_L = 2\text{ k}\Omega$, $C_L = 100\text{ pF}$, See Figure 1 | 25°C | 35 | | | 35 | | | V/ μ s | |
| | | Full range | 23 | | | 23 | | | | |
| SR- Negative slew rate | | 25°C | 38 | | | 38 | | | V/ μ s | |
| | | Full range | 23 | | | 23 | | | | |
| t_s Settling time | $A_{VD} = -1$, 2-V step, $R_L = 1\text{ k}\Omega$, $C_L = 100\text{ pF}$ | 25°C | To 10 mV | 0.25 | | | 0.25 | | | μ s |
| | | | To 1 mV | 0.4 | | | 0.4 | | | |
| V_n Equivalent input noise voltage | $R_S = 20\ \Omega$, See Figure 3 | 25°C | $f = 10\text{ Hz}$ | 28 | | | 28 | | | nV/ $\sqrt{\text{Hz}}$ |
| | | | $f = 10\text{ kHz}$ | 11.6 | | | 11.6 | | | |
| $V_{N(PP)}$ Peak-to-peak equivalent input noise voltage | | $f = 10\text{ Hz to } 10\text{ kHz}$ | 25°C | 6 | | | 6 | | | μ V |
| | | | | $f = 0.1\text{ Hz to } 10\text{ Hz}$ | 0.6 | | | 0.6 | | |
| I_n Equivalent input noise current | $V_{IC} = 0$, $f = 10\text{ kHz}$ | 25°C | 2.8 | | | 2.8 | | | fA/ $\sqrt{\text{Hz}}$ | |
| THD + N Total harmonic distortion plus noise | $V_{O(PP)} = 5\text{ V}$, $A_{VD} = 10$, $f = 1\text{ kHz}$, $R_L = 2\text{ k}\Omega$, $R_S = 25\ \Omega$ | 25°C | 0.013% | | | 0.013% | | | | |
| B_1 Unity-gain bandwidth | $V_I = 10\text{ mV}$, $R_L = 2\text{ k}\Omega$, $C_L = 25\text{ pF}$, See Figure 2 | 25°C | 9.4 | | | 9.4 | | | MHz | |
| B_{OM} Maximum output-swing bandwidth | $V_{O(PP)} = 4\text{ V}$, $A_{VD} = -1$, $R_L = 2\text{ k}\Omega$, $C_L = 25\text{ pF}$ | 25°C | 2.8 | | | 2.8 | | | MHz | |
| ϕ_m Phase margin at unity gain | $V_I = 10\text{ mV}$, $R_L = 2\text{ k}\Omega$, $C_L = 25\text{ pF}$, See Figure 2 | 25°C | 56° | | | 56° | | | | |

† Full range is 0°C to 70°C.



TLE208x, TLE208xA, TLE208xY
EXCALIBUR HIGH-SPEED JFET-INPUT
OPERATIONAL AMPLIFIERS

SLOS182B – FEBRUARY 1997 – REVISED JUNE 2001

TLE2081C electrical characteristics at specified free-air temperature, $V_{CC\pm} = \pm 15$ V (unless otherwise noted)

| PARAMETER | TEST CONDITIONS | T_A † | TLE2081C | | | TLE2081AC | | | UNIT | |
|---|--|----------------------------|-------------|-------------|-----|-------------|-------------|------------------|----------|----|
| | | | MIN | TYP | MAX | MIN | TYP | MAX | | |
| V_{IO} Input offset voltage | $V_{IC} = 0, V_O = 0, R_S = 50 \Omega$ | 25°C | 0.49 | 6 | | 0.47 | 3 | mV | | |
| | | Full range | | | 8 | | 5 | | | |
| α_{VIO} Temperature coefficient of input offset voltage | | Full range | 3.2 | 29 | | 3.2 | 29 | $\mu V/^\circ C$ | | |
| I_{IO} Input offset current | $V_{IC} = 0, V_O = 0, \text{See Figure 4}$ | 25°C | 6 | 100 | | 6 | 100 | nA | | |
| | | Full range | | 1.4 | | | 1.4 | | | |
| I_{IB} Input bias current | | 25°C | 20 | 175 | | 20 | 175 | nA | | |
| | | Full range | | 5 | | | 5 | | | |
| V_{ICR} Common-mode input voltage range | $R_S = 50 \Omega$ | 25°C | 15 to -11 | 15 to -11.9 | | 15 to -11 | 15 to -11.9 | V | | |
| | | Full range | 15 to -10.9 | | | 15 to -10.9 | | | | |
| V_{OM+} Maximum positive peak output voltage swing | $I_O = -200 \mu A$ | 25°C | 13.8 | 14.1 | | 13.8 | 14.1 | V | | |
| | | Full range | 13.7 | | | 13.7 | | | | |
| | $I_O = -2 \text{ mA}$ | 25°C | 13.5 | 13.9 | | 13.5 | 13.9 | | | |
| | | Full range | 13.4 | | | 13.4 | | | | |
| | $I_O = -20 \text{ mA}$ | 25°C | 11.5 | 12.3 | | 11.5 | 12.3 | | | |
| | | Full range | 11.5 | | | 11.5 | | | | |
| V_{OM-} Maximum negative peak output voltage swing | $I_O = 200 \mu A$ | 25°C | -13.8 | -14.2 | | -13.8 | -14.2 | V | | |
| | | Full range | -13.7 | | | -13.7 | | | | |
| | $I_O = 2 \text{ mA}$ | 25°C | -13.5 | -14 | | -13.5 | -14 | | | |
| | | Full range | -13.4 | | | -13.4 | | | | |
| | $I_O = 20 \text{ mA}$ | 25°C | -11.5 | -12.4 | | -11.5 | -12.4 | | | |
| | | Full range | -11.5 | | | -11.5 | | | | |
| A_{VD} Large-signal differential voltage amplification | $V_O = \pm 10 \text{ V}$ | $R_L = 600 \Omega$ | 25°C | 80 | 96 | | 80 | 96 | dB | |
| | | | Full range | 79 | | | 79 | | | |
| | | $R_L = 2 \text{ k}\Omega$ | 25°C | 90 | 109 | | 90 | 109 | | |
| | | | Full range | 89 | | | 89 | | | |
| | | $R_L = 10 \text{ k}\Omega$ | 25°C | 95 | 118 | | 95 | 118 | | |
| | | | Full range | 94 | | | 94 | | | |
| r_i Input resistance | $V_{IC} = 0$ | 25°C | 10^{12} | | | 10^{12} | | | Ω | |
| c_i Input capacitance | $V_{IC} = 0, \text{See Figure 5}$ | Common mode | 25°C | 7.5 | | | 7.5 | | | pF |
| | | Differential | 25°C | 2.5 | | | 2.5 | | | |
| z_o Open-loop output impedance | $f = 1 \text{ MHz}$ | 25°C | 80 | | | 80 | | | Ω | |
| CMRR Common-mode rejection ratio | $V_{IC} = V_{ICRmin}, V_O = 0, R_S = 50 \Omega$ | 25°C | 80 | 98 | | 80 | 98 | dB | | |
| | | Full range | 79 | | | 79 | | | | |
| k_{SVR} Supply-voltage rejection ratio ($\Delta V_{CC\pm} / \Delta V_{IO}$) | $V_{CC\pm} = \pm 5 \text{ V to } \pm 15 \text{ V}, V_O = 0, R_S = 50 \Omega$ | 25°C | 82 | 99 | | 82 | 99 | dB | | |
| | | Full range | 80 | | | 81 | | | | |

† Full range is 0°C to 70°C.



TLE208x, TLE208xA, TLE208xY
EXCALIBUR HIGH-SPEED JFET-INPUT
OPERATIONAL AMPLIFIERS

SLOS182B – FEBRUARY 1997 – REVISED JUNE 2001

TLE2081C electrical characteristics at specified free-air temperature, $V_{CC\pm} = \pm 15\text{ V}$ (unless otherwise noted) (continued)

| PARAMETER | TEST CONDITIONS | T_A † | TLE2081C | | | TLE2081AC | | | UNIT |
|---------------------------------------|---------------------|------------|------------------------|-----|---------|-----------|---------|-----|------|
| | | | MIN | TYP | MAX | MIN | TYP | MAX | |
| I_{CC} Supply current | $V_O = 0$, No load | 25°C | 1.35 | 1.7 | 2.2 | 1.35 | 1.7 | 2.2 | mA |
| | | Full range | 2.2 | | | 2.2 | | | |
| I_{OS} Short-circuit output current | $V_O = 0$ | 25°C | $V_{ID} = 1\text{ V}$ | | -30 -45 | | -30 -45 | | mA |
| | | | $V_{ID} = -1\text{ V}$ | | 30 48 | | 30 48 | | |

† Full range is 0°C to 70°C.

TLE2081C operating characteristics at specified free-air temperature, $V_{CC\pm} = \pm 15\text{ V}$

| PARAMETER | TEST CONDITIONS | T_A † | TLE2081C | | | TLE2081AC | | | UNIT |
|---|---|------------|---------------------|-----|--------|-----------|------------------------|-----|------------------------|
| | | | MIN | TYP | MAX | MIN | TYP | MAX | |
| SR+ Positive slew rate | $V_{O(PP)} = 10\text{ V}$, $A_{VD} = -1$, $R_L = 2\text{ k}\Omega$, $C_L = 100\text{ pF}$, See Figure 1 | 25°C | 30 | 40 | | 30 | 40 | | V/ μ s |
| | | Full range | 27 | | | 27 | | | |
| SR- Negative slew rate | | 25°C | 30 | 45 | | 30 | 45 | | V/ μ s |
| | | Full range | 27 | | | 27 | | | |
| t_s Settling time | $A_{VD} = -1$, 10-V step, $R_L = 1\text{ k}\Omega$, $C_L = 100\text{ pF}$ | 25°C | To 10 mV | | 0.4 | | 0.4 | | μ s |
| | | | To 1 mV | | 1.5 | | 1.5 | | |
| V_n Equivalent input noise voltage | $R_S = 20\ \Omega$, See Figure 3 | 25°C | f = 10 Hz | | 28 | | 28 | | nV/ $\sqrt{\text{Hz}}$ |
| | | | f = 10 kHz | | 11.6 | | 11.6 | | |
| $V_{N(PP)}$ Peak-to-peak equivalent input noise voltage | | 25°C | f = 10 Hz to 10 kHz | | 6 | | 6 | | μ V |
| | | | f = 0.1 Hz to 10 Hz | | 0.6 | | 0.6 | | |
| I_n Equivalent input noise current | $V_{IC} = 0$, f = 10 kHz | 25°C | 2.8 | | 2.8 | | fA/ $\sqrt{\text{Hz}}$ | | |
| THD + N Total harmonic distortion plus noise | $V_{O(PP)} = 20\text{ V}$, $A_{VD} = 10$, f = 1 kHz, $R_L = 2\text{ k}\Omega$, $R_S = 25\ \Omega$ | 25°C | 0.008% | | 0.008% | | | | |
| B_1 Unity-gain bandwidth | $V_I = 10\text{ mV}$, $R_L = 2\text{ k}\Omega$, $C_L = 25\text{ pF}$, See Figure 2 | 25°C | 8 | 10 | | 8 | 10 | MHz | |
| B_{OM} Maximum output-swing bandwidth | $V_{O(PP)} = 20\text{ V}$, $A_{VD} = -1$, $R_L = 2\text{ k}\Omega$, $C_L = 25\text{ pF}$ | 25°C | 478 | 637 | | 478 | 637 | kHz | |
| ϕ_m Phase margin at unity gain | $V_I = 10\text{ mV}$, $R_L = 2\text{ k}\Omega$, $C_L = 25\text{ pF}$, See Figure 2 | 25°C | 57° | | 57° | | | | |

† Full range is 0°C to 70°C.



TLE208x, TLE208xA, TLE208xY
EXCALIBUR HIGH-SPEED JFET-INPUT
OPERATIONAL AMPLIFIERS

SLOS182B – FEBRUARY 1997 – REVISED JUNE 2001

TLE2081I electrical characteristics at specified free-air temperature, $V_{CC\pm} = \pm 5\text{ V}$ (unless otherwise noted)

| PARAMETER | TEST CONDITIONS | T_A † | TLE2081I | | | TLE2081AI | | | UNIT | |
|---|--|----------------------------|------------|-----------|------|-----------|-----------|------|------------------------------|----|
| | | | MIN | TYP | MAX | MIN | TYP | MAX | | |
| V_{IO} Input offset voltage | $V_{IC} = 0,$ $R_S = 50\ \Omega,$ $V_O = 0,$ | 25°C | 0.34 | | 6 | 0.3 | | 3 | mV | |
| | | Full range | | | 7.6 | | | 5.6 | | |
| αV_{IO} Temperature coefficient of input offset voltage | | Full range | 3.2 | | 29 | 3.2 | | 29 | $\mu\text{V}/^\circ\text{C}$ | |
| I_{IO} Input offset current | $V_{IC} = 0,$ $V_O = 0,$ See Figure 4 | 25°C | 5 | | 100 | 5 | | 100 | pA | |
| | | Full range | | | 5 | | | 5 | nA | |
| I_{IB} Input bias current | | 25°C | 15 | | 175 | 15 | | 175 | pA | |
| | | Full range | | | 10 | | | 10 | nA | |
| V_{ICR} Common-mode input voltage range | $R_S = 50\ \Omega$ | 25°C | 5 to -1 | 5 to -1.9 | | 5 to -1 | 5 to -1.9 | | V | |
| | | Full range | 5 to -0.8 | | | 5 to -0.8 | | | | |
| V_{OM+} Maximum positive peak output voltage swing | $I_O = -200\ \mu\text{A}$ | 25°C | 3.8 | | 4.1 | 3.8 | | 4.1 | V | |
| | | Full range | | | 3.7 | | | 3.7 | | |
| | $I_O = -2\ \text{mA}$ | 25°C | 3.5 | | 3.9 | 3.5 | | 3.9 | | |
| | | Full range | | | 3.4 | | | 3.4 | | |
| | $I_O = -20\ \text{mA}$ | 25°C | 1.5 | | 2.3 | 1.5 | | 2.3 | | |
| | | Full range | | | 1.5 | | | 1.5 | | |
| V_{OM-} Maximum negative peak output voltage swing | $I_O = 200\ \mu\text{A}$ | 25°C | -3.8 | | -4.2 | -3.8 | | -4.2 | V | |
| | | Full range | | | -3.7 | | | -3.7 | | |
| | $I_O = 2\ \text{mA}$ | 25°C | -3.5 | | -4.1 | -3.5 | | -4.1 | | |
| | | Full range | | | -3.4 | | | -3.4 | | |
| | $I_O = 20\ \text{mA}$ | 25°C | -1.5 | | -2.4 | -1.5 | | -2.4 | | |
| | | Full range | | | -1.5 | | | -1.5 | | |
| A_{VD} Large-signal differential voltage amplification | $V_O = \pm 2.3\ \text{V}$ | $R_L = 600\ \Omega$ | 25°C | 80 | | 91 | 80 | | 91 | dB |
| | | | Full range | | | 79 | | | 79 | |
| | | $R_L = 2\ \text{k}\Omega$ | 25°C | 90 | | 100 | 90 | | 100 | |
| | | | Full range | | | 89 | | | 89 | |
| | | $R_L = 10\ \text{k}\Omega$ | 25°C | 95 | | 106 | 95 | | 106 | |
| | | | Full range | | | 94 | | | 94 | |
| r_i Input resistance | $V_{IC} = 0$ | 25°C | 10^{12} | | | 10^{12} | | | Ω | |
| c_i Input capacitance | $V_{IC} = 0,$ See Figure 5 | Common mode | 25°C | 11 | | | 11 | | | pF |
| | | Differential | 25°C | 2.5 | | | 2.5 | | | |
| z_o Open-loop output impedance | $f = 1\ \text{MHz}$ | 25°C | 80 | | | 80 | | | Ω | |
| CMRR Common-mode rejection ratio | $V_{IC} = V_{ICRmin},$ $V_O = 0,$ $R_S = 50\ \Omega$ | 25°C | 70 | | 89 | 70 | | 89 | dB | |
| | | Full range | | | 68 | | | 68 | | |
| k_{SVR} Supply-voltage rejection ratio ($\Delta V_{CC\pm}/\Delta V_{IO}$) | $V_{CC\pm} = \pm 5\ \text{V}$ to $\pm 15\ \text{V},$ $V_O = 0,$ $R_S = 50\ \Omega$ | 25°C | 82 | | 99 | 82 | | 99 | dB | |
| | | Full range | | | 80 | | | 80 | | |

† Full range is -40°C to 85°C .



TLE208x, TLE208xA, TLE208xY
EXCALIBUR HIGH-SPEED JFET-INPUT
OPERATIONAL AMPLIFIERS

SLOS182B – FEBRUARY 1997 – REVISED JUNE 2001

TLE2081I electrical characteristics at specified free-air temperature, $V_{CC\pm} = \pm 5\text{ V}$ (unless otherwise noted) (continued)

| PARAMETER | TEST CONDITIONS | T_A † | TLE2081I | | | TLE2081AI | | | UNIT |
|---------------------------------------|---------------------|------------------------|----------|-----|-----|-----------|-----|-----|------|
| | | | MIN | TYP | MAX | MIN | TYP | MAX | |
| I_{CC} Supply current | $V_O = 0$, No load | 25°C | 1.35 | 1.6 | 2.2 | 1.35 | 1.6 | 2.2 | mA |
| | | Full range | 2.2 | | | 2.2 | | | |
| I_{OS} Short-circuit output current | $V_O = 0$ | $V_{ID} = 1\text{ V}$ | -35 | | | -35 | | | mA |
| | | $V_{ID} = -1\text{ V}$ | 45 | | | 45 | | | |

† Full range is -40°C to 85°C .

TLE2081I operating characteristics at specified free-air temperature, $V_{CC\pm} = \pm 5\text{ V}$

| PARAMETER | TEST CONDITIONS | T_A † | TLE2081I | | | TLE2081AI | | | UNIT |
|---|--|---------------------|----------|-----|-----|-----------|-----|-----|------------------------|
| | | | MIN | TYP | MAX | MIN | TYP | MAX | |
| SR+ Positive slew rate | $V_{O(PP)} = \pm 2.3\text{ V}$, $A_{VD} = -1$, $R_L = 2\text{ k}\Omega$, $C_L = 100\text{ pF}$, See Figure 1 | 25°C | 35 | | | 35 | | | V/ μs |
| | | Full range | 22 | | | 22 | | | |
| SR- Negative slew rate | | 25°C | 38 | | | 38 | | | V/ μs |
| | | Full range | 22 | | | 22 | | | |
| t_s Settling time | $A_{VD} = -1$, 2-V step, $R_L = 1\text{ k}\Omega$, $C_L = 100\text{ pF}$ | To 10 mV | 0.25 | | | 0.25 | | | μs |
| | | To 1 mV | 0.4 | | | 0.4 | | | |
| V_n Equivalent input noise voltage | $R_S = 20\ \Omega$, See Figure 3 | f = 10 Hz | 28 | | | 28 | | | nV/ $\sqrt{\text{Hz}}$ |
| | | f = 10 kHz | 11.6 | | | 11.6 | | | |
| $V_{N(PP)}$ Peak-to-peak equivalent input noise voltage | | f = 10 Hz to 10 kHz | 6 | | | 6 | | | μV |
| | | f = 0.1 Hz to 10 Hz | 0.6 | | | 0.6 | | | |
| I_n Equivalent input noise current | $V_{IC} = 0$, f = 10 kHz | 25°C | 2.8 | | | 2.8 | | | fA/ $\sqrt{\text{Hz}}$ |
| THD + N Total harmonic distortion plus noise | $V_{O(PP)} = 5\text{ V}$, $A_{VD} = 10$, f = 1 kHz, $R_L = 2\text{ k}\Omega$, $R_S = 25\ \Omega$ | 25°C | 0.013% | | | 0.013% | | | |
| B_1 Unity-gain bandwidth | $V_I = 10\text{ mV}$, $R_L = 2\text{ k}\Omega$, $C_L = 25\text{ pF}$, See Figure 2 | 25°C | 9.4 | | | 9.4 | | | MHz |
| B_{OM} Maximum output-swing bandwidth | $V_{O(PP)} = 4\text{ V}$, $A_{VD} = -1$, $R_L = 2\text{ k}\Omega$, $C_L = 25\text{ pF}$ | 25°C | 2.8 | | | 2.8 | | | MHz |
| ϕ_m Phase margin at unity gain | $V_I = 10\text{ mV}$, $R_L = 2\text{ k}\Omega$, $C_L = 25\text{ pF}$, See Figure 2 | 25°C | 56° | | | 56° | | | |

† Full range is -40°C to 85°C .



TLE208x, TLE208xA, TLE208xY
EXCALIBUR HIGH-SPEED JFET-INPUT
OPERATIONAL AMPLIFIERS

SLOS182B – FEBRUARY 1997 – REVISED JUNE 2001

TLE20811 electrical characteristics at specified free-air temperature, $V_{CC\pm} = \pm 15$ V (unless otherwise noted)

| PARAMETER | TEST CONDITIONS | T_A † | TLE20811 | | | TLE2081AI | | | UNIT | |
|---|---|-----------------------|-------------|-------------|-----|-------------|-------------|------------------|----------|----|
| | | | MIN | TYP | MAX | MIN | TYP | MAX | | |
| V_{IO} Input offset voltage | $V_{IC} = 0,$ $R_S = 50 \Omega,$ $V_O = 0,$ | 25°C | 0.49 | 6 | | 0.47 | 3 | mV | | |
| | | Full range | | | 7.6 | | 5.6 | | | |
| αV_{IO} Temperature coefficient of input offset voltage | | Full range | 3.2 | 29 | | 3.2 | 29 | $\mu V/^\circ C$ | | |
| I_{IO} Input offset current | $V_{IC} = 0,$ $V_O = 0,$ See Figure 4 | 25°C | 6 | 100 | | 6 | 100 | pA | | |
| | | Full range | | 5 | | | 5 | nA | | |
| I_{IB} Input bias current | | 25°C | 20 | 175 | | 20 | 175 | pA | | |
| | | Full range | | 10 | | | 10 | nA | | |
| V_{ICR} Common-mode input voltage range | $R_S = 50 \Omega$ | 25°C | 15 to -11 | 15 to -11.9 | | 15 to -11 | 15 to -11.9 | V | | |
| | | Full range | 15 to -10.8 | | | 15 to -10.8 | | | | |
| V_{OM+} Maximum positive peak output voltage swing | $I_O = -200 \mu A$ | 25°C | 13.8 | 14.1 | | 13.8 | 14.1 | V | | |
| | | Full range | 13.7 | | | 13.7 | | | | |
| | $I_O = -2$ mA | 25°C | 13.5 | 13.9 | | 13.5 | 13.9 | | | |
| | | Full range | 13.4 | | | 13.4 | | | | |
| | $I_O = -20$ mA | 25°C | 11.5 | 12.3 | | 11.5 | 12.3 | | | |
| | | Full range | 11.5 | | | 11.5 | | | | |
| V_{OM-} Maximum negative peak output voltage swing | $I_O = 200 \mu A$ | 25°C | -13.8 | -14.2 | | -13.8 | -14.2 | V | | |
| | | Full range | -13.7 | | | -13.7 | | | | |
| | $I_O = 2$ mA | 25°C | -13.5 | -14 | | -13.5 | -14 | | | |
| | | Full range | -13.4 | | | -13.4 | | | | |
| | $I_O = 20$ mA | 25°C | -11.5 | -12.4 | | -11.5 | -12.4 | | | |
| | | Full range | -11.5 | | | -11.5 | | | | |
| A_{VD} Large-signal differential voltage amplification | $V_O = \pm 10$ V | $R_L = 600 \Omega$ | 25°C | 80 | 96 | | 80 | 96 | dB | |
| | | | Full range | 79 | | | 79 | | | |
| | | $R_L = 2$ k Ω | 25°C | 90 | 109 | | 90 | 109 | | |
| | | | Full range | 89 | | | 89 | | | |
| | | $R_L = 10$ k Ω | 25°C | 95 | 118 | | 95 | 118 | | |
| | | | Full range | 94 | | | 94 | | | |
| r_i Input resistance | $V_{IC} = 0$ | 25°C | 10^{12} | | | 10^{12} | | | Ω | |
| c_i Input capacitance | $V_{IC} = 0,$ See Figure 5 | Common mode | 25°C | 7.5 | | | 7.5 | | | pF |
| | | Differential | 25°C | 2.5 | | | 2.5 | | | |
| z_o Open-loop output impedance | $f = 1$ MHz | 25°C | 80 | | | 80 | | | Ω | |
| CMRR Common-mode rejection ratio | $V_{IC} = V_{ICRmin},$ $V_O = 0,$ $R_S = 50 \Omega$ | 25°C | 80 | 98 | | 80 | 98 | dB | | |
| | | Full range | 79 | | | 79 | | | | |
| k_{SVR} Supply-voltage rejection ratio ($\Delta V_{CC\pm}/\Delta V_{IO}$) | $V_{CC\pm} = \pm 5$ V to ± 15 V, $V_O = 0,$ $R_S = 50 \Omega$ | 25°C | 82 | 99 | | 82 | 99 | dB | | |
| | | Full range | 80 | | | 80 | | | | |

† Full range is $-40^\circ C$ to $85^\circ C$.



TLE208x, TLE208xA, TLE208xY EXCALIBUR HIGH-SPEED JFET-INPUT OPERATIONAL AMPLIFIERS

SLOS182B – FEBRUARY 1997 – REVISED JUNE 2001

TLE2081I electrical characteristics at specified free-air temperature, $V_{CC\pm} = \pm 15\text{ V}$ (unless otherwise noted) (continued)

| PARAMETER | TEST CONDITIONS | T_A † | TLE2081I | | | TLE2081AI | | | UNIT |
|---------------------------------------|---------------------|------------|------------------------|-----|---------|-----------|---------|-----|------|
| | | | MIN | TYP | MAX | MIN | TYP | MAX | |
| I_{CC} Supply current | $V_O = 0$, No load | 25°C | 1.35 | 1.7 | 2.2 | 1.35 | 1.7 | 2.2 | mA |
| | | Full range | 2.2 | | | 2.2 | | | |
| I_{OS} Short-circuit output current | $V_O = 0$ | 25°C | $V_{ID} = 1\text{ V}$ | | -30 -45 | | -30 -45 | | mA |
| | | | $V_{ID} = -1\text{ V}$ | | 30 48 | | 30 48 | | |

† Full range is -40°C to 85°C .

TLE2081I operating characteristics at specified free-air temperature, $V_{CC\pm} = \pm 15\text{ V}$

| PARAMETER | TEST CONDITIONS | T_A † | TLE2081I | | | TLE2081AI | | | UNIT | |
|---|---|-------------------------------------|---------------------|-------------------------------------|------|-----------|------|-----|------------------------|---------------|
| | | | MIN | TYP | MAX | MIN | TYP | MAX | | |
| SR+ Positive slew rate | $V_{O(PP)} = \pm 10\text{ V}$, $A_{VD} = -1$, $C_L = 100\text{ pF}$, $R_L = 2\text{ k}\Omega$, See Figure 1 | 25°C | 30 | 40 | | 30 | 40 | | V/ μs | |
| | | Full range | 24 | | | 24 | | | | |
| SR- Negative slew rate | | 25°C | 30 | 45 | | 30 | 45 | | V/ μs | |
| | | Full range | 24 | | | 24 | | | | |
| t_s Settling time | $A_{VD} = -1$, 10-V step, $R_L = 1\text{ k}\Omega$, $C_L = 100\text{ pF}$ | 25°C | To 10 mV | | 0.4 | | 0.4 | | μs | |
| | | | To 1 mV | | 1.5 | | 1.5 | | | |
| V_n Equivalent input noise voltage | $R_S = 20\ \Omega$, See Figure 3 | 25°C | $f = 10\text{ Hz}$ | | 28 | | 28 | | nV/ $\sqrt{\text{Hz}}$ | |
| | | | $f = 10\text{ kHz}$ | | 11.6 | | 11.6 | | | |
| $V_{N(PP)}$ Peak-to-peak equivalent input noise voltage | | $f = 10\text{ Hz to }10\text{ kHz}$ | 25°C | | | 6 | | 6 | | μV |
| | | | | $f = 0.1\text{ Hz to }10\text{ Hz}$ | | 0.6 | | 0.6 | | |
| I_n Equivalent input noise current | $V_{IC} = 0$, $f = 10\text{ kHz}$ | 25°C | 2.8 | | | 2.8 | | | fA/ $\sqrt{\text{Hz}}$ | |
| THD + N Total harmonic distortion plus noise | $V_{O(PP)} = 20\text{ V}$, $A_{VD} = 10$, $f = 1\text{ kHz}$, $R_L = 2\text{ k}\Omega$, $R_S = 25\ \Omega$ | 25°C | 0.008% | | | 0.008% | | | | |
| B_1 Unity-gain bandwidth | $V_I = 10\text{ mV}$, $R_L = 2\text{ k}\Omega$, $C_L = 25\text{ pF}$, See Figure 2 | 25°C | 8 | 10 | | 8 | 10 | | MHz | |
| BOM Maximum output-swing bandwidth | $V_{O(PP)} = 20\text{ V}$, $A_{VD} = -1$, $R_L = 2\text{ k}\Omega$, $C_L = 25\text{ pF}$ | 25°C | 478 | 637 | | 478 | 637 | | kHz | |
| ϕ_m Phase margin at unity gain | $V_I = 10\text{ mV}$, $R_L = 2\text{ k}\Omega$, $C_L = 25\text{ pF}$, See Figure 2 | 25°C | 57° | | | 57° | | | | |

† Full range is -40°C to 85°C .



TLE208x, TLE208xA, TLE208xY
EXCALIBUR HIGH-SPEED JFET-INPUT
OPERATIONAL AMPLIFIERS

SLOS182B – FEBRUARY 1997 – REVISED JUNE 2001

TLE2081M electrical characteristics at specified free-air temperature, $V_{CC\pm} = \pm 5\text{ V}$ (unless otherwise noted)

| PARAMETER | TEST CONDITIONS | T_A † | TLE2081M | | | TLE2081AM | | | UNIT | |
|---|---|---------------------------|------------|-----------|------|-----------|-----------|------------------------------|----------|----|
| | | | MIN | TYP | MAX | MIN | TYP | MAX | | |
| V_{IO} Input offset voltage | $V_{IC} = 0,$ $V_O = 0,$ $R_S = 50\Omega$ | 25°C | 0.34 | 6 | | 0.3 | 3 | mV | | |
| | | Full range | | | 11.2 | | 8.2 | | | |
| α_{VIO} Temperature coefficient of input offset voltage | | Full range | 3.2 | 29* | | 3.2 | 29* | $\mu\text{V}/^\circ\text{C}$ | | |
| I_{IO} Input offset current | $V_{IC} = 0,$ $V_O = 0,$ See Figure 4 | 25°C | 5 | 100 | | 5 | 100 | pA | | |
| | | Full range | | | 20 | | 20 | nA | | |
| I_{IB} Input bias current | | 25°C | 15 | 175 | | 15 | 175 | pA | | |
| | | Full range | | | 65 | | 65 | nA | | |
| V_{ICR} Common-mode input voltage range | $R_S = 50\Omega$ | 25°C | 5 to -1 | 5 to -1.9 | | 5 to -1 | 5 to -1.9 | V | | |
| | | Full range | 5 to -0.8 | | | 5 to -0.8 | | | | |
| V_{OM+} Maximum positive peak output voltage swing | $I_O = -200\mu\text{A}$ | 25°C | 3.8 | 4.1 | | 3.8 | 4.1 | V | | |
| | | Full range | 3.6 | | | 3.6 | | | | |
| | $I_O = -2\text{ mA}$ | 25°C | 3.5 | 3.9 | | 3.5 | 3.9 | | | |
| | | Full range | 3.3 | | | 3.3 | | | | |
| | $I_O = -20\text{ mA}$ | 25°C | 1.5 | 2.3 | | 1.5 | 2.3 | | | |
| | | Full range | 1.4 | | | 1.4 | | | | |
| V_{OM-} Maximum negative peak output voltage swing | $I_O = 200\mu\text{A}$ | 25°C | -3.8 | -4.2 | | -3.8 | -4.2 | V | | |
| | | Full range | -3.6 | | | -3.6 | | | | |
| | $I_O = 2\text{ mA}$ | 25°C | -3.5 | -4.1 | | -3.5 | -4.1 | | | |
| | | Full range | -3.3 | | | -3.3 | | | | |
| | $I_O = 20\text{ mA}$ | 25°C | -1.5 | -2.4 | | -1.5 | -2.4 | | | |
| | | Full range | -1.4 | | | -1.4 | | | | |
| A_{VD} Large-signal differential voltage amplification | $V_O = \pm 2.3\text{ V}$ | $R_L = 600\Omega$ | 25°C | 80 | 91 | | 80 | 91 | dB | |
| | | | Full range | 78 | | | 78 | | | |
| | | $R_L = 2\text{ k}\Omega$ | 25°C | 90 | 100 | | 90 | 100 | | |
| | | | Full range | 88 | | | 88 | | | |
| | | $R_L = 10\text{ k}\Omega$ | 25°C | 95 | 106 | | 95 | 106 | | |
| | | | Full range | 93 | | | 93 | | | |
| r_i Input resistance | $V_{IC} = 0$ | 25°C | 10^{12} | | | 10^{12} | | | Ω | |
| c_i Input capacitance | $V_{IC} = 0,$ See Figure 5 | Common mode | 25°C | 11 | | | 11 | | | pF |
| | | Differential | 25°C | 2.5 | | | 2.5 | | | |
| z_o Open-loop output impedance | $f = 1\text{ MHz}$ | 25°C | 80 | | | 80 | | | Ω | |
| CMRR Common-mode rejection ratio | $V_{IC} = V_{ICRmin},$ $V_O = 0,$ $R_S = 50\Omega$ | 25°C | 70 | 89 | | 70 | 89 | dB | | |
| | | Full range | 68 | | | 68 | | | | |
| k_{SVR} Supply-voltage rejection ratio ($\Delta V_{CC\pm}/\Delta V_{IO}$) | $V_{CC\pm} = \pm 5\text{ V to } \pm 15\text{ V},$ $V_O = 0,$ $R_S = 50\Omega$ | 25°C | 82 | 99 | | 82 | 99 | dB | | |
| | | Full range | 80 | | | 80 | | | | |

*On products compliant with MIL-PRF-38535, Class B, this parameter is not production tested.

† Full range is -55°C to 125°C .



TLE208x, TLE208xA, TLE208xY EXCALIBUR HIGH-SPEED JFET-INPUT OPERATIONAL AMPLIFIERS

SLOS182B – FEBRUARY 1997 – REVISED JUNE 2001

TLE2081M electrical characteristics at specified free-air temperature, $V_{CC\pm} = \pm 5\text{ V}$ (unless otherwise noted) (continued)

| PARAMETER | TEST CONDITIONS | T_A † | TLE2081M | | | TLE2081AM | | | UNIT | |
|-----------|------------------------------|---------------------|------------------------|------|-----|-----------|------|-----|------|----|
| | | | MIN | TYP | MAX | MIN | TYP | MAX | | |
| I_{CC} | Supply current | $V_O = 0$, No load | 25°C | 1.35 | 1.6 | 2.2 | 1.35 | 1.6 | 2.2 | mA |
| | | | Full range | 2.2 | | | 2.2 | | | |
| I_{OS} | Short-circuit output current | $V_O = 0$ | $V_{ID} = 1\text{ V}$ | -35 | | | -35 | | | mA |
| | | | $V_{ID} = -1\text{ V}$ | 45 | | | 45 | | | |

† Full range is -55°C to 125°C .

TLE2081M operating characteristics at specified free-air temperature, $V_{CC\pm} = \pm 5\text{ V}$

| PARAMETER | TEST CONDITIONS | T_A † | TLE2081M | | | TLE2081AM | | | UNIT | |
|-------------|---|--|---------------------|--------|-----|-----------|--------|-----|------|------------------------------|
| | | | MIN | TYP | MAX | MIN | TYP | MAX | | |
| $SR+$ | Positive slew rate | $V_{O(PP)} = \pm 2.3\text{ V}$, $A_{VD} = -1$, $R_L = 2\text{ k}\Omega$, $C_L = 100\text{ pF}$, See Figure 1 | 25°C | 35 | | | 35 | | | $\text{V}/\mu\text{s}$ |
| | | | Full range | 20* | | | 20* | | | |
| $SR-$ | Negative slew rate | $V_{O(PP)} = \pm 2.3\text{ V}$, $A_{VD} = -1$, $R_L = 2\text{ k}\Omega$, $C_L = 100\text{ pF}$, See Figure 1 | 25°C | 38 | | | 38 | | | $\text{V}/\mu\text{s}$ |
| | | | Full range | 20* | | | 20* | | | |
| t_s | Settling time | $A_{VD} = -1$, 2-V step, $R_L = 1\text{ k}\Omega$, $C_L = 100\text{ pF}$ | To 10 mV | 0.25 | | | 0.25 | | | μs |
| | | | To 1 mV | 0.4 | | | 0.4 | | | |
| V_n | Equivalent input noise voltage | $R_S = 20\ \Omega$, See Figure 3 | f = 10 Hz | 28 | | | 28 | | | $\text{nV}/\sqrt{\text{Hz}}$ |
| | | | f = 10 kHz | 11.6 | | | 11.6 | | | |
| $V_{N(PP)}$ | Peak-to-peak equivalent input noise voltage | $R_S = 20\ \Omega$, See Figure 3 | f = 10 Hz to 10 kHz | 6 | | | 6 | | | μV |
| | | | f = 0.1 Hz to 10 Hz | 0.6 | | | 0.6 | | | |
| I_n | Equivalent input noise current | $V_{IC} = 0$, f = 10 kHz | 25°C | 2.8 | | | 2.8 | | | $\text{fA}/\sqrt{\text{Hz}}$ |
| THD + N | Total harmonic distortion plus noise | $V_{O(PP)} = 5\text{ V}$, f = 1 kHz, $R_S = 25\ \Omega$ | 25°C | 0.013% | | | 0.013% | | | |
| B_1 | Unity-gain bandwidth | $V_I = 10\text{ mV}$, $C_L = 25\text{ pF}$, $R_L = 2\text{ k}\Omega$, See Figure 2 | 25°C | 9.4 | | | 9.4 | | | MHz |
| B_{OM} | Maximum output-swing bandwidth | $V_{O(PP)} = 4\text{ V}$, $R_L = 2\text{ k}\Omega$, $C_L = 25\text{ pF}$ | 25°C | 2.8 | | | 2.8 | | | MHz |
| ϕ_m | Phase margin at unity gain | $V_I = 10\text{ mV}$, $C_L = 25\text{ pF}$, $R_L = 2\text{ k}\Omega$, See Figure 2 | 25°C | 56° | | | 56° | | | |

*On products compliant with MIL-PRF-38535, Class B, this parameter is not production tested.

† Full range is -55°C to 125°C .



TLE208x, TLE208xA, TLE208xY
EXCALIBUR HIGH-SPEED JFET-INPUT
OPERATIONAL AMPLIFIERS

SLOS182B – FEBRUARY 1997 – REVISED JUNE 2001

TLE2081M electrical characteristics at specified free-air temperature, $V_{CC\pm} = \pm 15$ V (unless otherwise noted)

| PARAMETER | TEST CONDITIONS | T_A † | TLE2081M | | | TLE2081AM | | | UNIT |
|---|---|-----------------------|------------|-------------|-------------|-------------|-------------|------------------|------|
| | | | MIN | TYP | MAX | MIN | TYP | MAX | |
| V_{IO} Input offset voltage | $V_{IC} = 0,$ $R_S = 50 \Omega$ | $V_O = 0,$ | 25°C | 0.49 | 6 | 0.47 | 3 | mV | |
| | | | Full range | 11.2 | | | 8.2 | | |
| α_{VIO} Temperature coefficient of input offset voltage | | | Full range | 3.2 | 29* | 3.2 | 29* | $\mu V/^\circ C$ | |
| I_{IO} Input offset current | $V_{IC} = 0,$ See Figure 4 | $V_O = 0,$ | 25°C | 6 | 100 | 6 | 100 | pA | |
| | | | Full range | 20 | | | 20 | | |
| I_{IB} Input bias current | | | 25°C | 20 | 175 | 20 | 175 | pA | |
| | | | Full range | 65 | | | 65 | | |
| V_{ICR} Common-mode input voltage range | $R_S = 50 \Omega$ | | 25°C | 15 to -11 | 15 to -11.9 | 15 to -11 | 15 to -11.9 | V | |
| | | | Full range | 15 to -10.8 | | 15 to -10.8 | | | |
| V_{OM+} Maximum positive peak output voltage swing | $I_O = -200 \mu A$ | | 25°C | 13.8 | 14.1 | 13.8 | 14.1 | V | |
| | | | Full range | 13.6 | | | 13.6 | | |
| | $I_O = -2$ mA | | 25°C | 13.5 | 13.9 | 13.5 | 13.9 | | |
| | | | Full range | 13.3 | | | 13.3 | | |
| | $I_O = -20$ mA | | 25°C | 11.5 | 12.3 | 11.5 | 12.3 | | |
| | | | Full range | 11.4 | | | 11.4 | | |
| V_{OM-} Maximum negative peak output voltage swing | $I_O = 200 \mu A$ | | 25°C | -13.8 | -14.2 | -13.8 | -14.2 | V | |
| | | | Full range | -13.6 | | | -13.6 | | |
| | $I_O = 2$ mA | | 25°C | -13.5 | -14 | -13.5 | -14 | | |
| | | | Full range | -13.3 | | | -13.3 | | |
| | $I_O = 20$ mA | | 25°C | -11.5 | -12.4 | -11.5 | -12.4 | | |
| | | | Full range | -11.4 | | | -11.4 | | |
| A_{VD} Large-signal differential voltage amplification | $V_O = \pm 10$ V | $R_L = 600 \Omega$ | 25°C | 80 | 96 | 80 | 96 | dB | |
| | | | Full range | 78 | | | 78 | | |
| | | $R_L = 2$ k Ω | 25°C | 90 | 109 | 90 | 109 | | |
| | | | Full range | 88 | | | 88 | | |
| | | $R_L = 10$ k Ω | 25°C | 95 | 118 | 95 | 118 | | |
| | | | Full range | 93 | | | 93 | | |
| r_i Input resistance | $V_{IC} = 0$ | | 25°C | 10^{12} | | | 10^{12} | Ω | |
| c_i Input capacitance | $V_{IC} = 0,$ See Figure 5 | Common mode | 25°C | 7.5 | | | 7.5 | pF | |
| | | Differential | 25°C | 2.5 | | | 2.5 | | |
| z_o Open-loop output impedance | $f = 1$ MHz | | 25°C | 80 | | | 80 | Ω | |
| CMRR Common-mode rejection ratio | $V_{IC} = V_{ICRmin},$ $V_O = 0,$ $R_S = 50 \Omega$ | | 25°C | 80 | 98 | 80 | 98 | dB | |
| | | | Full range | 78 | | | 78 | | |
| k_{SVR} Supply-voltage rejection ratio ($\Delta V_{CC\pm} / \Delta V_{IO}$) | $V_{CC\pm} = \pm 5$ V to ± 15 V, $V_O = 0,$ $R_S = 50 \Omega$ | | 25°C | 82 | 99 | 82 | 99 | dB | |
| | | | Full range | 80 | | | 80 | | |

*On products compliant with MIL-PRF-38535, Class B, this parameter is not production tested.

† Full range is $-55^\circ C$ to $125^\circ C$.



TLE208x, TLE208xA, TLE208xY EXCALIBUR HIGH-SPEED JFET-INPUT OPERATIONAL AMPLIFIERS

SLOS182B – FEBRUARY 1997 – REVISED JUNE 2001

TLE2081M electrical characteristics at specified free-air temperature, $V_{CC\pm} = \pm 15\text{ V}$ (unless otherwise noted)(continued)

| PARAMETER | TEST CONDITIONS | T_A † | TLE2081M | | | TLE2081AM | | | UNIT | |
|-----------|------------------------------|------------------------|------------|------------------------|-----|-----------|------|-----|------|----|
| | | | MIN | TYP | MAX | MIN | TYP | MAX | | |
| I_{CC} | Supply current | $V_O = 0$, No load | 25°C | 1.35 | 1.7 | 2.2 | 1.35 | 1.7 | 2.2 | mA |
| | | | Full range | 2.2 | | | 2.2 | | | |
| I_{OS} | Short-circuit output current | $V_O = 0$ | 25°C | $V_{ID} = 1\text{ V}$ | -30 | -45 | -30 | -45 | mA | |
| | | | | $V_{ID} = -1\text{ V}$ | 30 | 48 | 30 | 48 | | |

† Full range is -55°C to 125°C .

TLE2081M operating characteristics at specified free-air temperature, $V_{CC\pm} = \pm 15\text{ V}$

| PARAMETER | TEST CONDITIONS | T_A † | TLE2081M | | | TLE2081AM | | | UNIT | |
|-------------|---|---|---------------------|--------|-----|-----------|--------|------------------------|------|------------------------------|
| | | | MIN | TYP | MAX | MIN | TYP | MAX | | |
| SR+ | Positive slew rate | $V_{O(PP)} = 10\text{ V}$, $A_{VD} = -1$, $C_L = 100\text{ pF}$, $R_L = 2\text{ k}\Omega$, See Figure 1 | 25°C | 30 | 40 | 30 | 40 | $\text{V}/\mu\text{s}$ | | |
| | | | Full range | 22 | | | 22 | | | |
| SR- | Negative slew rate | $V_{O(PP)} = 10\text{ V}$, $A_{VD} = -1$, $C_L = 100\text{ pF}$, $R_L = 2\text{ k}\Omega$, See Figure 1 | 25°C | 30 | 45 | 30 | 45 | $\text{V}/\mu\text{s}$ | | |
| | | | Full range | 22 | | | 22 | | | |
| t_s | Settling time | $A_{VD} = -1$, 10-V step, $R_L = 1\text{ k}\Omega$, $C_L = 100\text{ pF}$ | To 10 mV | 0.4 | | | 0.4 | | | μs |
| | | | To 1 mV | 1.5 | | | 1.5 | | | |
| V_n | Equivalent input noise voltage | $R_S = 20\ \Omega$, See Figure 3 | f = 10 Hz | 28 | | | 28 | | | $\text{nV}/\sqrt{\text{Hz}}$ |
| | | | f = 10 kHz | 11.6 | | | 11.6 | | | |
| $V_{N(PP)}$ | Peak-to-peak equivalent input noise voltage | $R_S = 20\ \Omega$, See Figure 3 | f = 10 Hz to 10 kHz | 6 | | | 6 | | | μV |
| | | | f = 0.1 Hz to 10 Hz | 0.6 | | | 0.6 | | | |
| I_n | Equivalent input noise current | $V_{IC} = 0$, f = 10 kHz | 25°C | 2.8 | | | 2.8 | | | $\text{fA}/\sqrt{\text{Hz}}$ |
| THD + N | Total harmonic distortion plus noise | $V_{O(PP)} = 20\text{ V}$, f = 1 kHz, $R_S = 25\ \Omega$ | 25°C | 0.008% | | | 0.008% | | | |
| B_1 | Unity-gain bandwidth | $V_I = 10\text{ mV}$, $C_L = 25\text{ pF}$, $R_L = 2\text{ k}\Omega$, See Figure 2 | 25°C | 8* | 10 | 8* | 10 | MHz | | |
| BOM | Maximum output-swing bandwidth | $V_{O(PP)} = 20\text{ V}$, $R_L = 2\text{ k}\Omega$, $C_L = 25\text{ pF}$, $A_{VD} = -1$ | 25°C | 478* | 637 | 478* | 637 | kHz | | |
| ϕ_m | Phase margin at unity gain | $V_I = 10\text{ mV}$, $C_L = 25\text{ pF}$, $R_L = 2\text{ k}\Omega$, See Figure 2 | 25°C | 57° | | | 57° | | | |

*On products compliant with MIL-PRF-38535, Class B, this parameter is not production tested.

† Full range is -55°C to 125°C .



TLE208x, TLE208xA, TLE208xY
EXCALIBUR HIGH-SPEED JFET-INPUT
OPERATIONAL AMPLIFIERS

SLOS182B – FEBRUARY 1997 – REVISED JUNE 2001

TLE2081Y electrical characteristics at $V_{CC\pm} = \pm 15\text{ V}$, $T_A = 25^\circ\text{C}$

| PARAMETER | | TEST CONDITIONS | | TLE2081Y | | | UNIT |
|-----------|---|--|--------------------------------|------------------|------------------|-----|----------|
| | | | | MIN | TYP | MAX | |
| V_{IO} | Input offset voltage | $V_{IC} = 0$, | $V_O = 0$, $R_S = 50\ \Omega$ | 0.49 | 6 | | mV |
| I_{IO} | Input offset current | $V_{IC} = 0$, | $V_O = 0$, See Figure 4 | 6 | 100 | | pA |
| I_{IB} | Input bias current | | | 20 | 175 | | |
| V_{ICR} | Common-mode input voltage range | $R_S = 50\ \Omega$ | | 15 to -11 | 15 to 11.9 | | V |
| V_{OM+} | Maximum positive peak output voltage swing | $I_O = -200\ \mu\text{A}$ | | 13.8 | 14.1 | | V |
| | | $I_O = -2\ \text{mA}$ | | 13.5 | 13.9 | | |
| | | $I_O = -20\ \text{mA}$ | | 11.5 | 12.3 | | |
| V_{OM-} | Maximum negative peak output voltage swing | $I_O = 200\ \mu\text{A}$ | | -13.8 | -14.2 | | V |
| | | $I_O = 2\ \text{mA}$ | | -13.5 | -14 | | |
| | | $I_O = 20\ \text{mA}$ | | -11.5 | -12.4 | | |
| A_{VD} | Large-signal differential voltage amplification | $V_O = \pm 10\ \text{V}$ | $R_L = 600\ \Omega$ | 80 | 96 | | dB |
| | | | $R_L = 2\ \text{k}\Omega$ | 90 | 109 | | |
| | | | $R_L = 10\ \text{k}\Omega$ | 95 | 118 | | |
| r_i | Input resistance | $V_{IC} = 0$ | | 10 ¹² | | | Ω |
| c_i | Input capacitance | $V_{IC} = 0$, See Figure 5 | Common mode | 7.5 | | | pF |
| | | | Differential | 2.5 | | | |
| z_o | Open-loop output impedance | $f = 1\ \text{MHz}$ | | 80 | | | Ω |
| CMRR | Common-mode rejection ratio | $V_{IC} = V_{ICR\text{min}}$, | $V_O = 0$, $R_S = 50\ \Omega$ | 80 | 98 | | dB |
| k_{SVR} | Supply-voltage rejection ratio ($\Delta V_{CC\pm} / \Delta V_{IO}$) | $V_{CC\pm} = \pm 5\ \text{V}$ to $\pm 15\ \text{V}$, $V_O = 0$, $R_S = 50\ \Omega$ | | 82 | 99 | | dB |
| I_{CC} | Supply current | $V_O = 0$, | No load | 1.35 | 1.7 | 2.2 | mA |
| I_{OS} | Short-circuit output current | $V_O = 0$ | $V_{ID} = 1\ \text{V}$ | -30 | -45 | | mA |
| | | | $V_{ID} = -1\ \text{V}$ | 30 | 48 | | |

TLE208x, TLE208xA, TLE208xY EXCALIBUR HIGH-SPEED JFET-INPUT OPERATIONAL AMPLIFIERS

SLOS182B – FEBRUARY 1997 – REVISED JUNE 2001

TLE2082C electrical characteristics at specified free-air temperature, $V_{CC\pm} = \pm 5$ V (unless otherwise noted)

| PARAMETER | TEST CONDITIONS | T_A † | TLE2082C | | | TLE2082AC | | | UNIT | |
|---|--|-----------------------------------|------------|-----------|------|-----------|-----------|------------------|----------|----|
| | | | MIN | TYP | MAX | MIN | TYP | MAX | | |
| V_{IO} Input offset voltage | $V_{IC} = 0, V_O = 0, R_S = 50 \Omega$ | 25°C | 0.9 | 6 | | 0.65 | 4 | mV | | |
| | | Full range | | | 8.1 | | 5.1 | | | |
| α_{VIO} Temperature coefficient of input offset voltage | | Full range | 2.3 | 25 | | 2.3 | 25 | $\mu V/^\circ C$ | | |
| I_{IO} Input offset current | $V_{IC} = 0, V_O = 0, \text{See Figure 4}$ | 25°C | 5 | 100 | | 5 | 100 | pA | | |
| | | Full range | | | 1.4 | | 1.4 | nA | | |
| I_{IB} Input bias current | | 25°C | 15 | 175 | | 15 | 175 | pA | | |
| | | Full range | | | 5 | | 5 | nA | | |
| V_{ICR} Common-mode input voltage range | $R_S = 50 \Omega$ | 25°C | 5 to -1 | 5 to -1.9 | | 5 to -1 | 5 to -1.9 | V | | |
| | | Full range | 5 to -0.9 | | | 5 to -0.9 | | | | |
| V_{OM+} Maximum positive peak output voltage swing | $I_O = -200 \mu A$ | 25°C | 3.8 | 4.1 | | 3.8 | 4.1 | V | | |
| | | Full range | | | 3.7 | | 3.7 | | | |
| | $I_O = -2 \text{ mA}$ | 25°C | 3.5 | 3.9 | | 3.5 | 3.9 | | | |
| | | Full range | | | 3.4 | | 3.4 | | | |
| | $I_O = -20 \text{ mA}$ | 25°C | 1.5 | 2.3 | | 1.5 | 2.3 | | | |
| | | Full range | | | 1.5 | | 1.5 | | | |
| V_{OM-} Maximum negative peak output voltage swing | $I_O = 200 \mu A$ | 25°C | -3.8 | -4.2 | | -3.8 | -4.2 | V | | |
| | | Full range | | | -3.7 | | -3.7 | | | |
| | $I_O = 2 \text{ mA}$ | 25°C | -3.5 | -4.1 | | -3.5 | -4.1 | | | |
| | | Full range | | | -3.4 | | -3.4 | | | |
| | $I_O = 20 \text{ mA}$ | 25°C | -1.5 | -2.4 | | -1.5 | -2.4 | | | |
| | | Full range | | | -1.5 | | -1.5 | | | |
| A_{VD} Large-signal differential voltage amplification | $V_O = \pm 2.3 \text{ V}$ | $R_L = 600 \Omega$ | 25°C | 80 | 91 | | 80 | 91 | dB | |
| | | | Full range | | | 79 | | 79 | | |
| | | $R_L = 2 \text{ k}\Omega$ | 25°C | 90 | 100 | | 90 | 100 | | |
| | | | Full range | | | 89 | | 89 | | |
| | | $R_L = 10 \text{ k}\Omega$ | 25°C | 95 | 106 | | 95 | 106 | | |
| | | | Full range | | | 94 | | 94 | | |
| r_i Input resistance | $V_{IC} = 0$ | 25°C | 10^{12} | | | 10^{12} | | | Ω | |
| c_i Input capacitance | Common mode | $V_{IC} = 0, \text{See Figure 5}$ | 25°C | 11 | | | 11 | | | pF |
| | Differential | | 25°C | 2.5 | | | 2.5 | | | |
| z_o Open-loop output impedance | $f = 1 \text{ MHz}$ | 25°C | 80 | | | 80 | | | Ω | |
| CMRR Common-mode rejection ratio | $V_{IC} = V_{ICRmin}, V_O = 0, R_S = 50 \Omega$ | 25°C | 70 | 89 | | 70 | 89 | dB | | |
| | | Full range | | | 68 | | 68 | | | |
| k_{SVR} Supply-voltage rejection ratio ($\Delta V_{CC\pm} / \Delta V_{IO}$) | $V_{CC\pm} = \pm 5 \text{ V to } \pm 15 \text{ V}, V_O = 0, R_S = 50 \Omega$ | 25°C | 82 | 99 | | 82 | 99 | dB | | |
| | | Full range | | | 80 | | 80 | | | |
| I_{CC} Supply current (both channels) | $V_O = 0, \text{No load}$ | 25°C | 2.7 | 2.9 | 3.9 | 2.7 | 2.9 | 3.9 | mA | |
| | | Full range | | | 3.9 | | 3.9 | | | |

† Full range is 0°C to 70°C.



TLE208x, TLE208xA, TLE208xY
EXCALIBUR HIGH-SPEED JFET-INPUT
OPERATIONAL AMPLIFIERS

SLOS182B – FEBRUARY 1997 – REVISED JUNE 2001

TLE2082C electrical characteristics at specified free-air temperature, $V_{CC\pm} = \pm 5$ V (unless otherwise noted) (continued)

| PARAMETER | TEST CONDITIONS | T_A | TLE2082C | | | TLE2082AC | | | UNIT |
|---------------------------------------|-------------------------------------|-------|-----------------|-----|-----|-----------|-----|-----|------|
| | | | MIN | TYP | MAX | MIN | TYP | MAX | |
| Crosstalk attenuation | $V_{IC} = 0$, $R_L = 2$ k Ω | 25°C | 120 | | | 120 | | | dB |
| I_{OS} Short-circuit output current | $V_O = 0$ | 25°C | $V_{ID} = 1$ V | | | -35 | | | mA |
| | | | $V_{ID} = -1$ V | | | 45 | | | |

TLE2082C operating characteristics at specified free-air temperature, $V_{CC\pm} = \pm 5$ V

| PARAMETER | TEST CONDITIONS | T_A † | TLE2082C | | | TLE2082AC | | | UNIT | |
|---|--|---|------------|------------------------|-----|-----------|--------|-----|-----------------|---------|
| | | | MIN | TYP | MAX | MIN | TYP | MAX | | |
| SR+ Positive slew rate | $V_{O(PP)} = \pm 2.3$ V, $A_{VD} = -1$, $R_L = 2$ k Ω , $C_L = 100$ pF, See Figure 1 | 25°C | 35 | | | 35 | | | V/ μ s | |
| | | Full range | 22 | | | 22 | | | | |
| SR- Negative slew rate | | 25°C | 38 | | | 38 | | | V/ μ s | |
| | | Full range | 22 | | | 22 | | | | |
| t_s Settling time | $A_{VD} = -1$, 2-V step, $R_L = 1$ k Ω , $C_L = 100$ pF | 25°C | To 10 mV | | | 0.25 | | | μ s | |
| | | | To 1 mV | | | 0.4 | | | | |
| V_n Equivalent input noise voltage | $R_S = 20$ Ω , See Figure 3 | 25°C | f = 10 Hz | | | 28 | | | nV/ \sqrt{Hz} | |
| | | | f = 10 kHz | | | 11.6 | | | | |
| $V_{N(PP)}$ Peak-to-peak equivalent input noise voltage | | f = 10 Hz to 10 kHz | 25°C | 6 | | | 6 | | | μ V |
| | | | | f = 0.1 Hz to 10 Hz | | | 0.6 | | | |
| I_n Equivalent input noise current | $V_{IC} = 0$, f = 10 kHz | 25°C | 2.8 | | | 2.8 | | | fA/ \sqrt{Hz} | |
| THD + N Total harmonic distortion plus noise | $V_{O(PP)} = 5$ V, f = 1 kHz, $R_S = 25$ Ω | $A_{VD} = 10$, $R_L = 2$ k Ω , | 25°C | 0.013% | | | 0.013% | | | |
| B_1 Unity-gain bandwidth | $V_I = 10$ mV, $C_L = 25$ pF, | $R_L = 2$ k Ω , See Figure 2 | 25°C | 9.4 | | | 9.4 | | | MHz |
| B_{OM} Maximum output-swing bandwidth | $V_{O(PP)} = 4$ V, $R_L = 2$ k Ω , | $A_{VD} = -1$, $C_L = 25$ pF | 25°C | 2.8 | | | 2.8 | | | MHz |
| ϕ_m Phase margin at unity gain | $V_I = 10$ mV, $C_L = 25$ pF, | $R_L = 2$ k Ω , See Figure 2 | 25°C | 56° | | | 56° | | | |

† Full range is 0°C to 70°C.

TLE208x, TLE208xA, TLE208xY EXCALIBUR HIGH-SPEED JFET-INPUT OPERATIONAL AMPLIFIERS

SLOS182B – FEBRUARY 1997 – REVISED JUNE 2001

TLE2082C electrical characteristics at specified free-air temperature, $V_{CC\pm} = \pm 15\text{ V}$ (unless otherwise noted)

| PARAMETER | TEST CONDITIONS | T_A † | TLE2082C | | | TLE2082AC | | | UNIT | |
|---|--|-------------------------------|-------------|-------------|-----|-------------|-------------|------------------------------|----------|----|
| | | | MIN | TYP | MAX | MIN | TYP | MAX | | |
| V_{IO} Input offset voltage | $V_{IC} = 0,$ $R_S = 50\ \Omega$ $V_O = 0,$ | 25°C | 1.1 | 7 | | 0.7 | 4 | mV | | |
| | | Full range | | | 8.1 | | 5.1 | | | |
| α_{VIO} Temperature coefficient of input offset voltage | | Full range | 2.4 | 25 | | 2.4 | 25 | $\mu\text{V}/^\circ\text{C}$ | | |
| I_{IO} Input offset current | $V_{IC} = 0,$ $V_O = 0,$ See Figure 4 | 25°C | 6 | 100 | | 6 | 100 | pA | | |
| | | Full range | | | 1.4 | | 1.4 | nA | | |
| I_{IB} Input bias current | | 25°C | 20 | 175 | | 20 | 175 | pA | | |
| | | Full range | | | 5 | | 5 | nA | | |
| V_{ICR} Common-mode input voltage range | $R_S = 50\ \Omega$ | 25°C | 15 to -11 | 15 to -11.9 | | 15 to -11 | 15 to -11.9 | V | | |
| | | Full range | 15 to -10.9 | | | 15 to -10.9 | | | | |
| V_{OM+} Maximum positive peak output voltage swing | $I_O = -200\ \mu\text{A}$ | 25°C | 13.8 | 14.1 | | 13.8 | 14.1 | V | | |
| | | Full range | 13.6 | | | 13.6 | | | | |
| | $I_O = -2\ \text{mA}$ | 25°C | 13.5 | 13.9 | | 13.5 | 13.9 | | | |
| | | Full range | 13.4 | | | 13.4 | | | | |
| | $I_O = -20\ \text{mA}$ | 25°C | 11.5 | 12.3 | | 11.5 | 12.3 | | | |
| | | Full range | 11.5 | | | 11.5 | | | | |
| V_{OM-} Maximum negative peak output voltage swing | $I_O = 200\ \mu\text{A}$ | 25°C | -13.8 | -14.2 | | -13.8 | -14.2 | V | | |
| | | Full range | -13.7 | | | -13.7 | | | | |
| | $I_O = 2\ \text{mA}$ | 25°C | -13.5 | -14 | | -13.5 | -14 | | | |
| | | Full range | -13.4 | | | -13.4 | | | | |
| | $I_O = 20\ \text{mA}$ | 25°C | -11.5 | -12.4 | | -11.5 | -12.4 | | | |
| | | Full range | -11.5 | | | -11.5 | | | | |
| A_{VD} Large-signal differential voltage amplification | $V_O = \pm 10\ \text{V}$ | $R_L = 600\ \Omega$ | 25°C | 80 | 96 | | 80 | 96 | dB | |
| | | | Full range | 79 | | | 79 | | | |
| | | $R_L = 2\ \text{k}\Omega$ | 25°C | 90 | 109 | | 90 | 109 | | |
| | | | Full range | 89 | | | 89 | | | |
| | | $R_L = 10\ \text{k}\Omega$ | 25°C | 95 | 118 | | 95 | 118 | | |
| | | | Full range | 94 | | | 94 | | | |
| r_i Input resistance | $V_{IC} = 0$ | 25°C | 10^{12} | | | 10^{12} | | | Ω | |
| c_i Input capacitance | Common mode | $V_{IC} = 0,$ See Figure 5 | 25°C | 7.5 | | | 7.5 | | | pF |
| | Differential | | 25°C | 2.5 | | | 2.5 | | | |
| z_o Open-loop output impedance | $f = 1\ \text{MHz}$ | 25°C | 80 | | | 80 | | | Ω | |
| CMRR Common-mode rejection ratio | $V_{IC} = V_{ICRmin},$ $V_O = 0,$ $R_S = 50\ \Omega$ | 25°C | 80 | 98 | | 80 | 98 | dB | | |
| | | Full range | 79 | | | 79 | | | | |
| k_{SVR} Supply-voltage rejection ratio ($\Delta V_{CC\pm}/\Delta V_{IO}$) | $V_{CC\pm} = \pm 5\ \text{V}$ to $\pm 15\ \text{V},$ $V_O = 0,$ $R_S = 50\ \Omega$ | 25°C | 82 | 99 | | 82 | 99 | dB | | |
| | | Full range | 81 | | | 81 | | | | |

† Full range is 0°C to 70°C.



TLE208x, TLE208xA, TLE208xY
EXCALIBUR HIGH-SPEED JFET-INPUT
OPERATIONAL AMPLIFIERS

SLOS182B – FEBRUARY 1997 – REVISED JUNE 2001

TLE2082C electrical characteristics at specified free-air temperature, $V_{CC\pm} = \pm 15$ V (unless otherwise noted) (continued)

| PARAMETER | TEST CONDITIONS | T_A | TLE2082C | | | TLE2082AC | | | UNIT |
|---|-------------------------------------|-----------------|----------|-----|-----|-----------|-----|-----|------|
| | | | MIN | TYP | MAX | MIN | TYP | MAX | |
| I_{CC} Supply current (both channels) | $V_O = 0$, No load | 25°C | 2.7 | 3.1 | 3.9 | 2.7 | 3.1 | 3.9 | mA |
| | | Full range | 3.9 | | | 3.9 | | | |
| Crosstalk attenuation | $V_{IC} = 0$, $R_L = 2$ k Ω | 25°C | 120 | | | 120 | | | dB |
| I_{OS} Short-circuit output current | $V_O = 0$ | $V_{ID} = 1$ V | 25°C | -30 | -45 | -30 | -45 | mA | |
| | | $V_{ID} = -1$ V | 30 | 48 | 30 | 48 | | | |

TLE2082C operating characteristics at specified free-air temperature, $V_{CC\pm} = \pm 15$ V

| PARAMETER | TEST CONDITIONS | T_A † | TLE2082C | | | TLE2082AC | | | UNIT |
|---|--|---------------------|----------|-----|-----|-----------|-----|------------|-----------------|
| | | | MIN | TYP | MAX | MIN | TYP | MAX | |
| SR+ Positive slew rate | $V_{O(PP)} = 10$ V, $A_{VD} = -1$, $R_L = 2$ k Ω , $C_L = 100$ pF, See Figure 1 | 25°C | 28 | 40 | | 28 | 40 | V/ μ s | |
| | | Full range | 25 | | | 25 | | | |
| SR- Negative slew rate | | 25°C | 30 | 45 | | 30 | 45 | V/ μ s | |
| | | Full range | 25 | | | 25 | | | |
| t_s Settling time | $A_{VD} = -1$, 10-V step, $R_L = 1$ k Ω , $C_L = 100$ pF | To 10 mV | 0.4 | | | 0.4 | | | μ s |
| | | To 1 mV | 1.5 | | | 1.5 | | | |
| V_n Equivalent input noise voltage | $R_S = 20$ Ω , See Figure 3 | f = 10 Hz | 28 | | | 28 | | | nV/ \sqrt{Hz} |
| | | f = 10 kHz | 11.6 | | | 11.6 | | | |
| $V_{N(PP)}$ Peak-to-peak equivalent input noise voltage | | f = 10 Hz to 10 kHz | 6 | | | 6 | | | μ V |
| | | f = 0.1 Hz to 10 Hz | 0.6 | | | 0.6 | | | |
| I_n Equivalent input noise current | $V_{IC} = 0$, f = 10 kHz | 25°C | 2.8 | | | 2.8 | | | fA/ \sqrt{Hz} |
| THD + N Total harmonic distortion plus noise | $V_{O(PP)} = 20$ V, $A_{VD} = 10$, f = 1 kHz, $R_L = 2$ k Ω , $R_S = 25$ Ω | 25°C | 0.008% | | | 0.008% | | | |
| B_1 Unity-gain bandwidth | $V_I = 10$ mV, $R_L = 2$ k Ω , $C_L = 25$ pF, See Figure 2 | 25°C | 8 | 10 | | 8 | 10 | MHz | |
| B_{OM} Maximum output-swing bandwidth | $V_{O(PP)} = 20$ V, $A_{VD} = -1$, $R_L = 2$ k Ω , $C_L = 25$ pF | 25°C | 478 | 637 | | 478 | 637 | kHz | |
| ϕ_m Phase margin at unity gain | $V_I = 10$ mV, $R_L = 2$ k Ω , $C_L = 25$ pF, See Figure 2 | 25°C | 57° | | | 57° | | | |

† Full range is 0°C to 70°C.

TLE208x, TLE208xA, TLE208xY EXCALIBUR HIGH-SPEED JFET-INPUT OPERATIONAL AMPLIFIERS

SLOS182B – FEBRUARY 1997 – REVISED JUNE 2001

TLE2082I electrical characteristics at specified free-air temperature, $V_{CC\pm} = \pm 5\text{ V}$ (unless otherwise noted)

| PARAMETER | TEST CONDITIONS | T_A † | TLE2082I | | | TLE2082AI | | | UNIT | |
|---|---|----------------------------|------------|-----------|------|-----------|-----------|------------------------------|----------|----|
| | | | MIN | TYP | MAX | MIN | TYP | MAX | | |
| V_{IO} Input offset voltage | $V_{IC} = 0, V_O = 0, R_S = 50\ \Omega$ | 25°C | 0.9 | 7 | | 0.65 | 4 | mV | | |
| | | Full range | | | 8.5 | | 5.5 | | | |
| α_{VIO} Temperature coefficient of input offset voltage | | Full range | 2.4 | 25 | | 2.4 | 25 | $\mu\text{V}/^\circ\text{C}$ | | |
| I_{IO} Input offset current | $V_{IC} = 0, V_O = 0, \text{See Figure 4}$ | 25°C | 5 | 100 | | 5 | 100 | pA | | |
| | | Full range | | | 5 | | 5 | nA | | |
| I_{IB} Input bias current | | 25°C | 15 | 175 | | 15 | 175 | pA | | |
| | | Full range | | | 10 | | 10 | nA | | |
| V_{ICR} Common-mode input voltage range | $R_S = 50\ \Omega$ | 25°C | 5 to -1 | 5 to -1.9 | | 5 to -1 | 5 to -1.9 | V | | |
| | | Full range | 5 to -0.8 | | | 5 to -0.8 | | | | |
| V_{OM+} Maximum positive peak output voltage swing | $I_O = -200\ \mu\text{A}$ | 25°C | 3.8 | 4.1 | | 3.8 | 4.1 | V | | |
| | | Full range | | | 3.7 | | 3.7 | | | |
| | $I_O = -2\ \text{mA}$ | 25°C | 3.5 | 3.9 | | 3.5 | 3.9 | | | |
| | | Full range | | | 3.4 | | 3.4 | | | |
| | $I_O = -20\ \text{mA}$ | 25°C | 1.5 | 2.3 | | 1.5 | 2.3 | | | |
| | | Full range | | | 1.5 | | 1.5 | | | |
| V_{OM-} Maximum negative peak output voltage swing | $I_O = 200\ \mu\text{A}$ | 25°C | -3.8 | -4.2 | | -3.8 | -4.2 | V | | |
| | | Full range | | | -3.7 | | -3.7 | | | |
| | $I_O = 2\ \text{mA}$ | 25°C | -3.5 | -4.1 | | -3.5 | -4.1 | | | |
| | | Full range | | | -3.4 | | -3.4 | | | |
| | $I_O = 20\ \text{mA}$ | 25°C | -1.5 | -2.4 | | -1.5 | -2.4 | | | |
| | | Full range | | | -1.5 | | -1.5 | | | |
| A_{VD} Large-signal differential voltage amplification | $V_O = \pm 2.3\ \text{V}$ | $R_L = 600\ \Omega$ | 25°C | 80 | 91 | | 80 | 91 | dB | |
| | | | Full range | | | 79 | | 79 | | |
| | | $R_L = 2\ \text{k}\Omega$ | 25°C | 90 | 100 | | 90 | 100 | | |
| | | | Full range | | | 89 | | 89 | | |
| | | $R_L = 10\ \text{k}\Omega$ | 25°C | 95 | 106 | | 95 | 106 | | |
| | | | Full range | | | 94 | | 94 | | |
| r_i Input resistance | $V_{IC} = 0$ | 25°C | 10^{12} | | | 10^{12} | | | Ω | |
| c_i Input capacitance | Common mode | $V_{IC} = 0$ | 25°C | 11 | | | 11 | | | pF |
| | Differential | See Figure 5 | 25°C | 2.5 | | | 2.5 | | | |
| z_o Open-loop output impedance | $f = 1\ \text{MHz}$ | 25°C | 80 | | | 80 | | | Ω | |
| CMRR Common-mode rejection ratio | $V_{IC} = V_{ICRmin}, V_O = 0, R_S = 50\ \Omega$ | 25°C | 70 | 89 | | 70 | 89 | dB | | |
| | | Full range | | | 68 | | 68 | | | |
| k_{SVR} Supply-voltage rejection ratio ($\Delta V_{CC\pm}/\Delta V_{IO}$) | $V_{CC\pm} = \pm 5\ \text{V to } \pm 15\ \text{V}, V_O = 0, R_S = 50\ \Omega$ | 25°C | 82 | 99 | | 82 | 99 | dB | | |
| | | Full range | | | 80 | | 80 | | | |
| I_{CC} Supply current (both channels) | $V_O = 0, \text{No load}$ | 25°C | 2.7 | 2.9 | 3.9 | 2.7 | 2.9 | 3.9 | mA | |
| | | Full range | | | 3.9 | | 3.9 | | | |

† Full range is -40°C to 85°C .



TLE208x, TLE208xA, TLE208xY
EXCALIBUR HIGH-SPEED JFET-INPUT
OPERATIONAL AMPLIFIERS

SLOS182B – FEBRUARY 1997 – REVISED JUNE 2001

TLE2082I electrical characteristics at specified free-air temperature, $V_{CC\pm} = \pm 5\text{ V}$ (unless otherwise noted) (continued)

| PARAMETER | TEST CONDITIONS | T_A | TLE2082I | | | TLE2082AI | | | UNIT |
|---------------------------------------|---|-------|------------------------|-----|-----|-----------|-----|-----|------|
| | | | MIN | TYP | MAX | MIN | TYP | MAX | |
| Crosstalk attenuation | $V_{IC} = 0$, $R_L = 2\text{ k}\Omega$ | 25°C | 120 | | | 120 | | | dB |
| I_{OS} Short-circuit output current | $V_O = 0$ | 25°C | $V_{ID} = 1\text{ V}$ | | | -35 | | | mA |
| | | | $V_{ID} = -1\text{ V}$ | | | 45 | | | |

TLE2082I operating characteristics at specified free-air temperature, $V_{CC\pm} = \pm 5\text{ V}$

| PARAMETER | TEST CONDITIONS | T_A † | TLE2082I | | | TLE2082AI | | | UNIT | |
|---|--|---|---------------------|--------|-----|-----------|--------|-----|------------------------|-----|
| | | | MIN | TYP | MAX | MIN | TYP | MAX | | |
| SR+ Positive slew rate | $V_{O(PP)} = \pm 2.3\text{ V}$, $A_{VD} = -1$, $R_L = 2\text{ k}\Omega$, $C_L = 100\text{ pF}$, See Figure 1 | 25°C | 35 | | | 35 | | | V/ μs | |
| | | Full range | 20 | | | 20 | | | | |
| SR- Negative slew rate | | 25°C | 38 | | | 38 | | | V/ μs | |
| | | Full range | 20 | | | 20 | | | | |
| t_s Settling time | $A_{VD} = -1$, 2-V step, $R_L = 1\text{ k}\Omega$, $C_L = 100\text{ pF}$ | 25°C | To 10 mV | | | 0.25 | | | μs | |
| | | | To 1 mV | | | 0.4 | | | | |
| V_n Equivalent input noise voltage | $R_S = 20\ \Omega$, See Figure 3 | 25°C | f = 10 Hz | | | 28 | | | nV/ $\sqrt{\text{Hz}}$ | |
| | | | f = 10 kHz | | | 11.6 | | | | |
| $V_{N(PP)}$ Peak-to-peak equivalent input noise voltage | | 25°C | f = 10 Hz to 10 kHz | | | 6 | | | μV | |
| | | | f = 0.1 Hz to 10 Hz | | | 0.6 | | | | |
| I_n Equivalent input noise current | $V_{IC} = 0$, f = 10 kHz | 25°C | 2.8 | | | 2.8 | | | fA/ $\sqrt{\text{Hz}}$ | |
| THD + N Total harmonic distortion plus noise | $V_{O(PP)} = 5\text{ V}$, f = 1 kHz, $R_S = 25\ \Omega$ | $A_{VD} = 10$, $R_L = 2\text{ k}\Omega$ | 25°C | 0.013% | | | 0.013% | | | |
| B_1 Unity-gain bandwidth | $V_I = 10\text{ mV}$, $C_L = 25\text{ pF}$ | $R_L = 2\text{ k}\Omega$, See Figure 2 | 25°C | 9.4 | | | 9.4 | | | MHz |
| B_{OM} Maximum output-swing bandwidth | $V_{O(PP)} = 4\text{ V}$, $R_L = 2\text{ k}\Omega$ | $A_{VD} = -1$, $C_L = 25\text{ pF}$ | 25°C | 2.8 | | | 2.8 | | | MHz |
| ϕ_m Phase margin at unity gain | $V_I = 10\text{ mV}$, $C_L = 25\text{ pF}$ | $R_L = 2\text{ k}\Omega$, See Figure 2 | 25°C | 56° | | | 56° | | | |

† Full range is 40°C to 85°C.

TLE208x, TLE208xA, TLE208xY EXCALIBUR HIGH-SPEED JFET-INPUT OPERATIONAL AMPLIFIERS

SLOS182B – FEBRUARY 1997 – REVISED JUNE 2001

TLE2082I electrical characteristics at specified free-air temperature, $V_{CC\pm} = \pm 15\text{ V}$ (unless otherwise noted)

| PARAMETER | TEST CONDITIONS | T_A † | TLE2082I | | | TLE2082AI | | | UNIT | |
|---|---|-------------------------------|-------------|-------------|-----|-------------|-------------|------------------------------|----------|----|
| | | | MIN | TYP | MAX | MIN | TYP | MAX | | |
| V_{IO} Input offset voltage | $V_{IC} = 0,$ $R_S = 50\ \Omega$ $V_O = 0,$ | 25°C | 1.1 | 7 | | 0.7 | 4 | mV | | |
| | | Full range | | | 8.5 | | 5.5 | | | |
| α_{VIO} Temperature coefficient of input offset voltage | | Full range | 2.4 | 25 | | 2.4 | 25 | $\mu\text{V}/^\circ\text{C}$ | | |
| I_{IO} Input offset current | $V_{IC} = 0,$ $V_O = 0,$ See Figure 4 | 25°C | 6 | 100 | | 6 | 100 | pA | | |
| | | Full range | | | 5 | | 5 | nA | | |
| I_{IB} Input bias current | | 25°C | 20 | 175 | | 20 | 175 | pA | | |
| | | Full range | | | 10 | | 10 | nA | | |
| V_{ICR} Common-mode input voltage range | $R_S = 50\ \Omega$ | 25°C | 15 to -11 | 15 to -11.9 | | 15 to -11 | 15 to -11.9 | V | | |
| | | Full range | 15 to -10.8 | | | 15 to -10.8 | | | | |
| V_{OM+} Maximum positive peak output voltage swing | $I_O = -200\ \mu\text{A}$ | 25°C | 13.8 | 14.1 | | 13.8 | 14.1 | V | | |
| | | Full range | 13.7 | | | 13.7 | | | | |
| | $I_O = -2\ \text{mA}$ | 25°C | 13.5 | 13.9 | | 13.5 | 13.9 | | | |
| | | Full range | 13.4 | | | 13.4 | | | | |
| | $I_O = -20\ \text{mA}$ | 25°C | 11.5 | 12.3 | | 11.5 | 12.3 | | | |
| | | Full range | 11.5 | | | 11.5 | | | | |
| V_{OM-} Maximum negative peak output voltage swing | $I_O = 200\ \mu\text{A}$ | 25°C | -13.8 | -14.2 | | -13.8 | -14.2 | V | | |
| | | Full range | -13.7 | | | -13.7 | | | | |
| | $I_O = 2\ \text{mA}$ | 25°C | -13.5 | -14 | | -13.5 | -14 | | | |
| | | Full range | -13.4 | | | -13.4 | | | | |
| | $I_O = 20\ \text{mA}$ | 25°C | -11.5 | -12.4 | | -11.5 | -12.4 | | | |
| | | Full range | -11.5 | | | -11.5 | | | | |
| A_{VD} Large-signal differential voltage amplification | $V_O = \pm 10\ \text{V}$ | $R_L = 600\ \Omega$ | 25°C | 80 | 96 | | 80 | 96 | dB | |
| | | | Full range | 79 | | | 79 | | | |
| | | $R_L = 2\ \text{k}\Omega$ | 25°C | 90 | 109 | | 90 | 109 | | |
| | | | Full range | 89 | | | 89 | | | |
| | | $R_L = 10\ \text{k}\Omega$ | 25°C | 95 | 118 | | 95 | 118 | | |
| | | | Full range | 94 | | | 94 | | | |
| r_i Input resistance | $V_{IC} = 0$ | 25°C | 10^{12} | | | 10^{12} | | | Ω | |
| c_i Input capacitance | Common mode | $V_{IC} = 0,$ See Figure 5 | 25°C | 7.5 | | | 7.5 | | | pF |
| | Differential | | 25°C | 2.5 | | | 2.5 | | | |
| z_o Open-loop output impedance | $f = 1\ \text{MHz}$ | 25°C | 80 | | | 80 | | | Ω | |
| CMRR Common-mode rejection ratio | $V_{IC} = V_{ICRmin},$ $V_O = 0,$ $R_S = 50\ \Omega$ | 25°C | 80 | 98 | | 80 | 98 | dB | | |
| | | Full range | 79 | | | 79 | | | | |
| k_{SVR} Supply-voltage rejection ratio ($\Delta V_{CC\pm} / \Delta V_{IO}$) | $V_{CC\pm} = \pm 5\ \text{V to } \pm 15\ \text{V},$ $V_O = 0,$ $R_S = 50\ \Omega$ | 25°C | 82 | 99 | | 82 | 99 | dB | | |
| | | Full range | 80 | | | 80 | | | | |

† Full range is -40°C to 85°C .



TLE208x, TLE208xA, TLE208xY
EXCALIBUR HIGH-SPEED JFET-INPUT
OPERATIONAL AMPLIFIERS

SLOS182B – FEBRUARY 1997 – REVISED JUNE 2001

TLE2082I electrical characteristics at specified free-air temperature, $V_{CC\pm} = \pm 15$ V (unless otherwise noted) (continued)

| PARAMETER | TEST CONDITIONS | T_A | TLE2082I | | | TLE2082AI | | | UNIT |
|---|-------------------------------------|------------|-----------------|-----|-----|-----------|-----|-----|------|
| | | | MIN | TYP | MAX | MIN | TYP | MAX | |
| I_{CC} Supply current (both channels) | $V_O = 0$, No load | 25°C | 2.7 | 3.1 | 3.9 | 2.7 | 3.1 | 3.9 | mA |
| | | Full range | 3.9 | | | 3.9 | | | |
| Crosstalk attenuation | $V_{IC} = 0$, $R_L = 2$ k Ω | 25°C | 120 | | | 120 | | | dB |
| I_{OS} Short-circuit output current | $V_O = 0$ | 25°C | $V_{ID} = 1$ V | -30 | -45 | -30 | -45 | mA | |
| | | | $V_{ID} = -1$ V | 30 | 48 | 30 | 48 | | |

TLE2082I operating characteristics at specified free-air temperature, $V_{CC\pm} = \pm 15$ V

| PARAMETER | TEST CONDITIONS | T_A † | TLE2082I | | | TLE2082AI | | | UNIT |
|---|--|------------|---------------------|------|--------|-----------|------------------------|------------------------|------|
| | | | MIN | TYP | MAX | MIN | TYP | MAX | |
| SR+ Positive slew rate | $V_{O(PP)} = 10$ V, $A_{VD} = -1$, $R_L = 2$ k Ω , $C_L = 100$ pF, See Figure 1 | 25°C | 28 | 40 | | 28 | 40 | V/ μ s | |
| | | Full range | 22 | | | 22 | | | |
| SR- Negative slew rate | | 25°C | 30 | 45 | | 30 | 45 | V/ μ s | |
| | | Full range | 22 | | | 22 | | | |
| t_s Settling time | $A_{VD} = -1$, 10-V step, $R_L = 1$ k Ω , $C_L = 100$ pF | 25°C | To 10 mV | 0.4 | | 0.4 | | μ s | |
| | | | To 1 mV | 1.5 | | 1.5 | | | |
| V_n Equivalent input noise voltage | $R_S = 20$ Ω , See Figure 3 | 25°C | f = 10 Hz | 28 | | 28 | | nV/ $\sqrt{\text{Hz}}$ | |
| | | | f = 10 kHz | 11.6 | | 11.6 | | | |
| $V_{N(PP)}$ Peak-to-peak equivalent input noise voltage | | 25°C | f = 10 Hz to 10 kHz | 6 | | 6 | | μ V | |
| | | | f = 0.1 Hz to 10 Hz | 0.6 | | 0.6 | | | |
| I_n Equivalent input noise current | $V_{IC} = 0$, f = 10 kHz | 25°C | 2.8 | | 2.8 | | fA/ $\sqrt{\text{Hz}}$ | | |
| THD + N Total harmonic distortion plus noise | $V_{O(PP)} = 20$ V, $A_{VD} = 10$, f = 1 kHz, $R_L = 2$ k Ω , $R_S = 25$ Ω | 25°C | 0.008% | | 0.008% | | | | |
| B_1 Unity-gain bandwidth | $V_I = 10$ mV, $R_L = 2$ k Ω , $C_L = 25$ pF, See Figure 2 | 25°C | 8 | 10 | 8 | 10 | MHz | | |
| B_{OM} Maximum output-swing bandwidth | $V_{O(PP)} = 20$ V, $A_{VD} = -1$, $R_L = 2$ k Ω , $C_L = 25$ pF | 25°C | 478 | 637 | 478 | 637 | kHz | | |
| ϕ_m Phase margin at unity gain | $V_I = 10$ mV, $R_L = 2$ k Ω , $C_L = 25$ pF, See Figure 2 | 25°C | 57° | | 57° | | | | |

† Full range is -40°C to 85°C.



TLE208x, TLE208xA, TLE208xY EXCALIBUR HIGH-SPEED JFET-INPUT OPERATIONAL AMPLIFIERS

SLOS182B – FEBRUARY 1997 – REVISED JUNE 2001

TLE2082M electrical characteristics at specified free-air temperature, $V_{CC\pm} = \pm 5\text{ V}$ (unless otherwise noted)

| PARAMETER | TEST CONDITIONS | T_A † | TLE2082M | | | TLE2082AM | | | UNIT | |
|---|---|-----------------------------------|------------|-----------|------|-----------|-----------|------------------------------|----------|----|
| | | | MIN | TYP | MAX | MIN | TYP | MAX | | |
| V_{IO} Input offset voltage | $V_{IC} = 0, V_O = 0, R_S = 50\ \Omega$ | 25°C | 0.9 | 7 | | 0.65 | 4 | mV | | |
| | | Full range | | | 9.5 | | 6.5 | | | |
| α_{VIO} Temperature coefficient of input offset voltage | | Full range | 2.3 | 25* | | 2.3 | 25* | $\mu\text{V}/^\circ\text{C}$ | | |
| I_{IO} Input offset current | $V_{IC} = 0, V_O = 0, \text{See Figure 4}$ | 25°C | 5 | 100 | | 5 | 100 | pA | | |
| | | Full range | | | 20 | | 20 | | | |
| I_{IB} Input bias current | | 25°C | 15 | 175 | | 15 | 175 | pA | | |
| | | Full range | | | 60 | | 60 | | | |
| V_{ICR} Common-mode input voltage range | $R_S = 50\ \Omega$ | 25°C | 5 to -1 | 5 to -1.9 | | 5 to -1 | 5 to -1.9 | V | | |
| | | Full range | 5 to -0.8 | | | 5 to -0.8 | | | | |
| V_{OM+} Maximum positive peak output voltage swing | $I_O = -200\ \mu\text{A}$ | 25°C | 3.8 | 4.1 | | 3.8 | 4.1 | V | | |
| | | Full range | 3.6 | | | 3.6 | | | | |
| | $I_O = -2\ \text{mA}$ | 25°C | 3.5 | 3.9 | | 3.5 | 3.9 | | | |
| | | Full range | 3.3 | | | 3.3 | | | | |
| $I_O = -20\ \text{mA}$ | 25°C | 1.5 | 2.3 | | 1.5 | 2.3 | | | | |
| | Full range | 1.4 | | | 1.4 | | | | | |
| V_{OM-} Maximum negative peak output voltage swing | $I_O = 200\ \mu\text{A}$ | 25°C | -3.8 | -4.2 | | -3.8 | -4.2 | V | | |
| | | Full range | -3.6 | | | -3.6 | | | | |
| | $I_O = 2\ \text{mA}$ | 25°C | -3.5 | -4.1 | | -3.5 | -4.1 | | | |
| | | Full range | -3.3 | | | -3.3 | | | | |
| $I_O = 20\ \text{mA}$ | 25°C | -1.5 | -2.4 | | -1.5 | -2.4 | | | | |
| | Full range | -1.4 | | | -1.4 | | | | | |
| A_{VD} Large-signal differential voltage amplification | $V_O = \pm 2.3\ \text{V}$ | $R_L = 600\ \Omega$ | 25°C | 80 | 91 | | 80 | 91 | dB | |
| | | | Full range | 78 | | | 78 | | | |
| | | $R_L = 2\ \text{k}\Omega$ | 25°C | 90 | 100 | | 90 | 100 | | |
| | | | Full range | 88 | | | 88 | | | |
| | | $R_L = 10\ \text{k}\Omega$ | 25°C | 95 | 106 | | 95 | 106 | | |
| | | | Full range | 93 | | | 93 | | | |
| r_i Input resistance | $V_{IC} = 0$ | 25°C | 10^{12} | | | 10^{12} | | | Ω | |
| c_i Input capacitance | Common mode | $V_{IC} = 0, \text{See Figure 5}$ | 25°C | 11 | | | 11 | | | pF |
| | Differential | | 25°C | 2.5 | | | 2.5 | | | |
| z_o Open-loop output impedance | $f = 1\ \text{MHz}$ | 25°C | 80 | | | 80 | | | Ω | |
| CMRR Common-mode rejection ratio | $V_{IC} = V_{ICR\text{min}}, V_O = 0, R_S = 50\ \Omega$ | 25°C | 70 | 89 | | 70 | 89 | dB | | |
| | | Full range | 68 | | | 68 | | | | |
| k_{SVR} Supply-voltage rejection ratio ($\Delta V_{CC\pm} / \Delta V_{IO}$) | $V_{CC\pm} = \pm 5\ \text{V to } \pm 15\ \text{V}, V_O = 0, R_S = 50\ \Omega$ | 25°C | 82 | 99 | | 82 | 99 | dB | | |
| | | Full range | 80 | | | 80 | | | | |

*On products compliant with MIL-PRF-38535, Class B, this parameter is not production tested.

† Full range is -55°C to 125°C .



TLE208x, TLE208xA, TLE208xY
EXCALIBUR HIGH-SPEED JFET-INPUT
OPERATIONAL AMPLIFIERS

SLOS182B – FEBRUARY 1997 – REVISED JUNE 2001

TLE2082M electrical characteristics at specified free-air temperature, $V_{CC\pm} = \pm 5\text{ V}$ (unless otherwise noted) (continued)

| PARAMETER | TEST CONDITIONS | T_A † | TLE2082M | | | TLE2082AM | | | UNIT |
|---|---|------------|------------------------|-----|-----|-----------|-----|-----|------|
| | | | MIN | TYP | MAX | MIN | TYP | MAX | |
| I_{CC} Supply current (both channels) | $V_O = 0$, No load | 25°C | 2.7 | 2.9 | 3.6 | 2.7 | 2.9 | 3.6 | mA |
| | | Full range | 3.6 | | | 3.6 | | | |
| Crosstalk attenuation | $V_{IC} = 0$, $R_L = 2\text{ k}\Omega$ | 25°C | 120 | | | 120 | | | dB |
| I_{OS} Short-circuit output current | $V_O = 0$ | 25°C | $V_{ID} = 1\text{ V}$ | | | -35 | | | mA |
| | | | $V_{ID} = -1\text{ V}$ | | | 45 | | | |

† Full range is -55°C to 125°C .

TLE2082M operating characteristics at specified free-air temperature, $V_{CC\pm} = \pm 5\text{ V}$

| PARAMETER | TEST CONDITIONS | T_A † | TLE2082M | | | TLE2082AM | | | UNIT | |
|---|--|---|---------------------|--------|-----|-----------|--------|-----|------------------------|-----|
| | | | MIN | TYP | MAX | MIN | TYP | MAX | | |
| SR+ Positive slew rate | $V_{O(PP)} = \pm 2.3\text{ V}$, $A_{VD} = -1$, $R_L = 2\text{ k}\Omega$, $C_L = 100\text{ pF}$, See Figure 1 | 25°C | 35 | | | 35 | | | V/ μs | |
| | | Full range | 18* | | | 18* | | | | |
| SR- Negative slew rate | $V_{O(PP)} = \pm 2.3\text{ V}$, $A_{VD} = -1$, $R_L = 2\text{ k}\Omega$, $C_L = 100\text{ pF}$, See Figure 1 | 25°C | 38 | | | 38 | | | V/ μs | |
| | | Full range | 18* | | | 18* | | | | |
| t_s Settling time | $A_{VD} = -1$, 2-V step, $R_L = 1\text{ k}\Omega$, $C_L = 100\text{ pF}$ | 25°C | To 10 mV | | | 0.25 | | | μs | |
| | | | To 1 mV | | | 0.4 | | | | |
| V_n Equivalent input noise voltage | $R_S = 20\ \Omega$, See Figure 3 | 25°C | f = 10 Hz | | | 28 | | | nV/ $\sqrt{\text{Hz}}$ | |
| | | | f = 10 kHz | | | 11.6 | | | | |
| $V_{N(PP)}$ Peak-to-peak equivalent input noise voltage | $R_S = 20\ \Omega$, See Figure 3 | 25°C | f = 10 Hz to 10 kHz | | | 6 | | | μV | |
| | | | f = 0.1 Hz to 10 Hz | | | 0.6 | | | | |
| I_n Equivalent input noise current | $V_{IC} = 0$, f = 10 kHz | 25°C | 2.8 | | | 2.8 | | | fA/ $\sqrt{\text{Hz}}$ | |
| THD + N Total harmonic distortion plus noise | $V_{O(PP)} = 5\text{ V}$, f = 1 kHz, $R_S = 25\ \Omega$ | $A_{VD} = 10$, $R_L = 2\text{ k}\Omega$ | 25°C | 0.013% | | | 0.013% | | | |
| B_1 Unity-gain bandwidth | $V_I = 10\text{ mV}$, $C_L = 25\text{ pF}$ | $R_L = 2\text{ k}\Omega$, See Figure 2 | 25°C | 9.4 | | | 9.4 | | | MHz |
| B_{OM} Maximum output-swing bandwidth | $V_{O(PP)} = 4\text{ V}$, $R_L = 2\text{ k}\Omega$ | $A_{VD} = -1$, $C_L = 25\text{ pF}$ | 25°C | 2.8 | | | 2.8 | | | MHz |
| ϕ_m Phase margin at unity gain | $V_I = 10\text{ mV}$, $C_L = 25\text{ pF}$ | $R_L = 2\text{ k}\Omega$, See Figure 2 | 25°C | 56° | | | 56° | | | |

*On products compliant with MIL-PRF-38535, Class B, this parameter is not production tested.

† Full range is -55°C to 125°C .

TLE208x, TLE208xA, TLE208xY EXCALIBUR HIGH-SPEED JFET-INPUT OPERATIONAL AMPLIFIERS

SLOS182B – FEBRUARY 1997 – REVISED JUNE 2001

TLE2082M electrical characteristics at specified free-air temperature, $V_{CC\pm} = \pm 15\text{ V}$ (unless otherwise noted)

| PARAMETER | TEST CONDITIONS | T_A † | TLE2082M | | | TLE2082AM | | | UNIT | |
|---|---|-----------------------------------|-------------|-------------|-----|-------------|-------------|------------------------------|----------|----|
| | | | MIN | TYP | MAX | MIN | TYP | MAX | | |
| V_{IO} Input offset voltage | $V_{IC} = 0, V_O = 0, R_S = 50\ \Omega$ | 25°C | 1.1 | 7 | | 0.7 | 4 | mV | | |
| | | Full range | | | 9.5 | | 6.5 | | | |
| α_{VIO} Temperature coefficient of input offset voltage | | Full range | 2.4 | 25* | | 2.4 | 25* | $\mu\text{V}/^\circ\text{C}$ | | |
| I_{IO} Input offset current | $V_{IC} = 0, V_O = 0, \text{See Figure 4}$ | 25°C | 6 | 100 | | 6 | 100 | pA | | |
| | | Full range | | | 20 | | 20 | nA | | |
| I_{IB} Input bias current | | 25°C | 20 | 175 | | 20 | 175 | pA | | |
| | | Full range | | | 65 | | 65 | nA | | |
| V_{ICR} Common-mode input voltage range | $R_S = 50\ \Omega$ | 25°C | 15 to -11 | 15 to -11.9 | | 15 to -11 | 15 to -11.9 | V | | |
| | | Full range | 15 to -10.8 | | | 15 to -10.8 | | | | |
| V_{OM+} Maximum positive peak output voltage swing | $I_O = -200\ \mu\text{A}$ | 25°C | 13.8 | 14.1 | | 13.8 | 14.1 | V | | |
| | | Full range | 13.6 | | | 13.6 | | | | |
| | $I_O = -2\ \text{mA}$ | 25°C | 13.5 | 13.9 | | 13.5 | 13.9 | | | |
| | | Full range | 13.3 | | | 13.3 | | | | |
| | $I_O = -20\ \text{mA}$ | 25°C | 11.5 | 12.3 | | 11.5 | 12.3 | | | |
| | | Full range | 11.4 | | | 11.4 | | | | |
| V_{OM-} Maximum negative peak output voltage swing | $I_O = 200\ \mu\text{A}$ | 25°C | -13.8 | -14.2 | | -13.8 | -14.2 | V | | |
| | | Full range | -13.6 | | | -13.6 | | | | |
| | $I_O = 2\ \text{mA}$ | 25°C | -13.5 | -14 | | -13.5 | -14 | | | |
| | | Full range | -13.3 | | | -13.3 | | | | |
| | $I_O = 20\ \text{mA}$ | 25°C | -11.5 | -12.4 | | -11.5 | -12.4 | | | |
| | | Full range | -11.4 | | | -11.4 | | | | |
| A_{VD} Large-signal differential voltage amplification | $V_O = \pm 10\ \text{V}$ | $R_L = 600\ \Omega$ | 25°C | 80 | 96 | | 80 | 96 | dB | |
| | | | Full range | 78 | | | 78 | | | |
| | | $R_L = 2\ \text{k}\Omega$ | 25°C | 90 | 109 | | 90 | 109 | | |
| | | | Full range | 88 | | | 88 | | | |
| | | $R_L = 10\ \text{k}\Omega$ | 25°C | 95 | 118 | | 95 | 118 | | |
| | | | Full range | 93 | | | 93 | | | |
| r_i Input resistance | $V_{IC} = 0$ | 25°C | 10^{12} | | | 10^{12} | | | Ω | |
| c_i Input capacitance | Common mode | $V_{IC} = 0, \text{See Figure 5}$ | 25°C | 7.5 | | | 7.5 | | | pF |
| | Differential | | 25°C | 2.5 | | | 2.5 | | | |
| z_o Open-loop output impedance | $f = 1\ \text{MHz}$ | 25°C | 80 | | | 80 | | | Ω | |
| CMRR Common-mode rejection ratio | $V_{IC} = V_{ICRmin}, V_O = 0, R_S = 50\ \Omega$ | 25°C | 80 | 98 | | 80 | 98 | dB | | |
| | | Full range | 78 | | | 78 | | | | |
| k_{SVR} Supply-voltage rejection ratio ($\Delta V_{CC\pm}/\Delta V_{IO}$) | $V_{CC\pm} = \pm 5\ \text{V to } \pm 15\ \text{V}, V_O = 0, R_S = 50\ \Omega$ | 25°C | 82 | 99 | | 82 | 99 | dB | | |
| | | Full range | 80 | | | 80 | | | | |

*On products compliant with MIL-PRF-38535, Class B, this parameter is not production tested.

† Full range is -55°C to 125°C .



TLE208x, TLE208xA, TLE208xY
EXCALIBUR HIGH-SPEED JFET-INPUT
OPERATIONAL AMPLIFIERS

SLOS182B – FEBRUARY 1997 – REVISED JUNE 2001

TLE2082M electrical characteristics at specified free-air temperature, $V_{CC\pm} = \pm 15$ V (unless otherwise noted) (continued)

| PARAMETER | TEST CONDITIONS | T_A † | TLE2082M | | | TLE2082AM | | | UNIT |
|---|-------------------------------------|-----------------|----------|-----|-----|-----------|-----|-----|------|
| | | | MIN | TYP | MAX | MIN | TYP | MAX | |
| I_{CC} Supply current (both channels) | $V_O = 0$, No load | 25°C | 2.7 | 3.1 | 3.6 | 2.7 | 3.1 | 3.6 | mA |
| | | Full range | 3.6 | | | 3.6 | | | |
| Crosstalk attenuation | $V_{IC} = 0$, $R_L = 2$ k Ω | 25°C | 120 | | | 120 | | | dB |
| I_{OS} Short-circuit output current | $V_O = 0$ | $V_{ID} = 1$ V | 25°C | -30 | -45 | -30 | -45 | mA | |
| | | $V_{ID} = -1$ V | | 30 | 48 | | | | 30 |

† Full range is -55°C to 125°C .

TLE2082M operating characteristics at specified free-air temperature, $V_{CC\pm} = \pm 15$ V

| PARAMETER | TEST CONDITIONS | T_A † | TLE2082M | | | TLE2082AM | | | UNIT |
|---|--|------------|---------------------|-----|-----|-----------|-----|------------|------------------------|
| | | | MIN | TYP | MAX | MIN | TYP | MAX | |
| SR+ Positive slew rate | $V_{O(PP)} = 10$ V, $A_{VD} = -1$, $R_L = 2$ k Ω , $C_L = 100$ pF, See Figure 1 | 25°C | 28 | 40 | | 28 | 40 | V/ μ s | |
| | | Full range | 20 | | | 20 | | | |
| SR- Negative slew rate | | 25°C | 30 | 45 | | 30 | 45 | V/ μ s | |
| | | Full range | 20 | | | 20 | | | |
| t_s Settling time | $A_{VD} = -1$, 10-V step, $R_L = 1$ k Ω , $C_L = 100$ pF | 25°C | To 10 mV | | | 0.4 | | | μ s |
| | | | To 1 mV | | | 1.5 | | | |
| V_n Equivalent input noise voltage | $R_S = 20$ Ω , See Figure 3 | 25°C | f = 10 Hz | | | 28 | | | nV/ $\sqrt{\text{Hz}}$ |
| | | | f = 10 kHz | | | 11.6 | | | |
| $V_{N(PP)}$ Peak-to-peak equivalent input noise voltage | | 25°C | f = 10 Hz to 10 kHz | | | 6 | | | μ V |
| | | | f = 0.1 Hz to 10 Hz | | | 0.6 | | | |
| I_n Equivalent input noise current | $V_{IC} = 0$, f = 10 kHz | 25°C | 2.8 | | | 2.8 | | | fA/ $\sqrt{\text{Hz}}$ |
| THD + N Total harmonic distortion plus noise | $V_{O(PP)} = 20$ V, $A_{VD} = 10$, f = 1 kHz, $R_L = 2$ k Ω , $R_S = 25$ Ω | 25°C | 0.008% | | | 0.008% | | | |
| B_1 Unity-gain bandwidth | $V_I = 10$ mV, $R_L = 2$ k Ω , $C_L = 25$ pF, See Figure 2 | 25°C | 8* | 10 | | 8* | 10 | MHz | |
| BOM Maximum output-swing bandwidth | $V_{O(PP)} = 20$ V, $A_{VD} = -1$, $R_L = 2$ k Ω , $C_L = 25$ pF | 25°C | 478* | 637 | | 478* | 637 | kHz | |
| ϕ_m Phase margin at unity gain | $V_I = 10$ mV, $R_L = 2$ k Ω , $C_L = 25$ pF, See Figure 2 | 25°C | 57° | | | 57° | | | |

*On products compliant with MIL-PRF-38535, Class B, this parameter is not production tested.

† Full range is -55°C to 125°C .



TLE208x, TLE208xA, TLE208xY
EXCALIBUR HIGH-SPEED JFET-INPUT
OPERATIONAL AMPLIFIERS

SLOS182B – FEBRUARY 1997 – REVISED JUNE 2001

TLE2082Y electrical characteristics at $V_{CC\pm} = \pm 15\text{ V}$, $T_A = 25^\circ\text{C}$

| PARAMETER | | TEST CONDITIONS | | | TLE2082Y | | | UNIT | |
|-----------|---|---|----------------------------|--------------------|-------------------------|------------------|-----|----------|----|
| | | | | | MIN | TYP | MAX | | |
| V_{IO} | Input offset voltage | $V_{IC} = 0$, | $V_O = 0$, | $R_S = 50\ \Omega$ | 1.1 | 6 | | mV | |
| I_{IO} | Input offset current | $V_{IC} = 0$, | $V_O = 0$, | See Figure 4 | 6 | 100 | | pA | |
| I_{IB} | Input bias current | | | | 20 | 175 | | pA | |
| V_{ICR} | Common-mode input voltage range | $R_S = 50\ \Omega$ | | | 15 to -11 | 15 to 11.9 | | V | |
| V_{OM+} | Maximum positive peak output voltage swing | $I_O = -200\ \mu\text{A}$ | | | 13.8 | 14.1 | | V | |
| | | $I_O = -2\ \text{mA}$ | | | 13.5 | 13.9 | | | |
| | | $I_O = -20\ \text{mA}$ | | | 11.5 | 12.3 | | | |
| V_{OM-} | Maximum negative peak output voltage swing | $I_O = 200\ \mu\text{A}$ | | | -13.8 | -14.2 | | V | |
| | | $I_O = 2\ \text{mA}$ | | | -13.5 | -14 | | | |
| | | $I_O = 20\ \text{mA}$ | | | -11.5 | -12.4 | | | |
| A_{VD} | Large-signal differential voltage amplification | $V_O = \pm 10\ \text{V}$ | $R_L = 600\ \Omega$ | | 80 | 96 | | dB | |
| | | | $R_L = 2\ \text{k}\Omega$ | | 90 | 109 | | | |
| | | | $R_L = 10\ \text{k}\Omega$ | | 95 | 118 | | | |
| r_i | Input resistance | $V_{IC} = 0$ | | | 10 ¹² | | | Ω | |
| c_i | Input capacitance | Common mode | $V_O = 0$, See Figure 5 | | | 7.5 | | pF | |
| | | Differential | | | | 2.5 | | | |
| z_o | Open-loop output impedance | $f = 1\ \text{MHz}$ | | | 80 | | | Ω | |
| CMRR | Common-mode rejection ratio | $V_{IC} = V_{ICRmin}$, $V_O = 0$, $R_S = 50\ \Omega$ | | | 80 | 98 | | dB | |
| k_{SVR} | Supply-voltage rejection ratio ($\Delta V_{CC\pm} / \Delta V_{IO}$) | $V_{CC\pm} = \pm 5\ \text{V to } \pm 15\ \text{V}$, $V_O = 0$, $R_S = 50\ \Omega$ | | | 82 | 99 | | dB | |
| I_{CC} | Supply current (both channels) | $V_O = 0$, No load | | | 2.7 | 3.1 | 3.9 | mA | |
| I_{OS} | Short-circuit output current | $V_O = 0$ | | | $V_{ID} = 1\ \text{V}$ | | -30 | -45 | mA |
| | | | | | $V_{ID} = -1\ \text{V}$ | | 30 | 48 | |



TLE208x, TLE208xA, TLE208xY
EXCALIBUR HIGH-SPEED JFET-INPUT
OPERATIONAL AMPLIFIERS

SLOS182B – FEBRUARY 1997 – REVISED JUNE 2001

TLE2084C electrical characteristics at specified free-air temperature, $V_{CC\pm} = \pm 5\text{ V}$ (unless otherwise noted)

| PARAMETER | TEST CONDITIONS | T_A † | TLE2084C | | | TLE2084AC | | | UNIT | |
|---|---|----------------------------|------------|-----------|-----|-----------|-----------|------------------------------|----------|----|
| | | | MIN | TYP | MAX | MIN | TYP | MAX | | |
| V_{IO} Input offset voltage | $V_{IC} = 0, V_O = 0, R_S = 50\ \Omega$ | 25°C | -1.6 | 7 | | -0.5 | 4 | mV | | |
| | | Full range | | | 9.1 | | 6.1 | | | |
| α_{VIO} Temperature coefficient of input offset voltage | | Full range | 10.1 | 30 | | 10.1 | 30 | $\mu\text{V}/^\circ\text{C}$ | | |
| I_{IO} Input offset current | $V_{IC} = 0, V_O = 0, \text{See Figure 4}$ | 25°C | 15 | 100 | | 15 | 100 | pA | | |
| | | Full range | | | 1.4 | | 1.4 | nA | | |
| I_{IB} Input bias current | | 25°C | 20 | 175 | | 20 | 175 | pA | | |
| | | Full range | | | 5 | | 5 | nA | | |
| V_{ICR} Common-mode input voltage range | $R_S = 50\ \Omega$ | 25°C | 5 to -1 | 5 to -1.9 | | 5 to -1 | 5 to -1.9 | V | | |
| | | Full range | 5 to -0.9 | | | 5 to -0.9 | | | | |
| V_{OM+} Maximum positive peak output voltage swing | $I_O = -200\ \mu\text{A}$ | 25°C | 3.8 | 4.1 | | 3.8 | 4.1 | V | | |
| | | Full range | 3.7 | | | 3.7 | | | | |
| | $I_O = -2\ \text{mA}$ | 25°C | 3.5 | 3.9 | | 3.5 | 3.9 | | | |
| | | Full range | 3.4 | | | 3.4 | | | | |
| | $I_O = -20\ \text{mA}$ | 25°C | 1.5 | 2.3 | | 1.5 | 2.3 | | | |
| | | Full range | 1.5 | | | 1.5 | | | | |
| V_{OM-} Maximum negative peak output voltage swing | $I_O = 200\ \mu\text{A}$ | 25°C | -3.8 | -4.2 | | -3.8 | -4.2 | V | | |
| | | Full range | -3.7 | | | -3.7 | | | | |
| | $I_O = 2\ \text{mA}$ | 25°C | -3.5 | -4.1 | | -3.5 | -4.1 | | | |
| | | Full range | -3.4 | | | -3.4 | | | | |
| | $I_O = 20\ \text{mA}$ | 25°C | -1.5 | -2.4 | | -1.5 | -2.4 | | | |
| | | Full range | -1.5 | | | -1.5 | | | | |
| A_{VD} Large-signal differential voltage amplification | $V_O = \pm 2.3\ \text{V}$ | $R_L = 600\ \Omega$ | 25°C | 80 | 91 | | 80 | 91 | dB | |
| | | | Full range | 79 | | | 79 | | | |
| | | $R_L = 2\ \text{k}\Omega$ | 25°C | 90 | 100 | | 90 | 100 | | |
| | | | Full range | 89 | | | 89 | | | |
| | | $R_L = 10\ \text{k}\Omega$ | 25°C | 95 | 106 | | 95 | 106 | | |
| | | | Full range | 94 | | | 94 | | | |
| r_i Input resistance | $V_{IC} = 0$ | 25°C | 10^{12} | | | 10^{12} | | | Ω | |
| c_i Input capacitance | $V_{IC} = 0, \text{See Figure 5}$ | Common mode | 25°C | 11 | | | 11 | | | pF |
| | | Differential | 25°C | 2.5 | | | 2.5 | | | |
| z_o Open-loop output impedance | $f = 1\ \text{MHz}$ | 25°C | 80 | | | 80 | | | Ω | |
| CMRR Common-mode rejection ratio | $V_{IC} = V_{ICRmin}, V_O = 0, R_S = 50\ \Omega$ | 25°C | 70 | 89 | | 70 | 89 | dB | | |
| | | Full range | 68 | | | 68 | | | | |
| k_{SVR} Supply-voltage rejection ratio ($\Delta V_{CC\pm} / \Delta V_{IO}$) | $V_{CC\pm} = \pm 5\ \text{V to } \pm 15\ \text{V}, V_O = 0, R_S = 50\ \Omega$ | 25°C | 82 | 99 | | 82 | 99 | dB | | |
| | | Full range | 80 | | | 80 | | | | |
| I_{CC} Supply current (four amplifiers) | $V_O = 0, \text{No load}$ | 25°C | 5.2 | 6.3 | 7.5 | 5.2 | 6.3 | 7.5 | mA | |
| | | Full range | | | 7.5 | | | 7.5 | | |
| a_x Crosstalk attenuation | $V_{IC} = 0, R_L = 2\ \text{k}\Omega$ | 25°C | 120 | | | 120 | | | dB | |

† Full range is 0°C to 70°C.



TLE208x, TLE208xA, TLE208xY
EXCALIBUR HIGH-SPEED JFET-INPUT
OPERATIONAL AMPLIFIERS

SLOS182B – FEBRUARY 1997 – REVISED JUNE 2001

TLE2084C electrical characteristics at specified free-air temperature, $V_{CC\pm} = \pm 5\text{ V}$ (unless otherwise noted) (continued)

| PARAMETER | TEST CONDITIONS | T_A † | TLE2084C | | | TLE2084AC | | | UNIT |
|-----------|---|---------|------------------------|-----|-----|-----------|-----|-----|------|
| | | | MIN | TYP | MAX | MIN | TYP | MAX | |
| I_{OS} | Short-circuit output current $V_O = 0$ | 25°C | $V_{ID} = 1\text{ V}$ | | | -35 | | | mA |
| | | | $V_{ID} = -1\text{ V}$ | | | 45 | | | |

† Full range is 0°C to 70°C.

TLE2084C operating characteristics at specified free-air temperature, $V_{CC\pm} = \pm 5\text{ V}$

| PARAMETER | TEST CONDITIONS | T_A † | TLE2084C | | | TLE2084AC | | | UNIT |
|-------------|--|------------|---------------------|-----|-----|-----------|-----|-----|------------------------------|
| | | | MIN | TYP | MAX | MIN | TYP | MAX | |
| SR+ | Positive slew rate $V_{O(PP)} = \pm 2.3\text{ V}$, $A_{VD} = -1$, $R_L = 2\text{ k}\Omega$, $C_L = 100\text{ pF}$, See Figure 1 | 25°C | 35 | | | 35 | | | $\text{V}/\mu\text{s}$ |
| | | Full range | 22 | | | 22 | | | |
| SR- | Negative slew rate | 25°C | 38 | | | 38 | | | $\text{V}/\mu\text{s}$ |
| | | Full range | 22 | | | 22 | | | |
| t_s | Settling time $A_{VD} = -1$, 2-V step, $R_L = 1\text{ k}\Omega$, $C_L = 100\text{ pF}$ | 25°C | To 10 mV | | | 0.25 | | | μs |
| | | | To 1 mV | | | 0.4 | | | |
| V_n | Equivalent input noise voltage $R_S = 20\ \Omega$, See Figure 3 | 25°C | f = 10 Hz | | | 28 | | | $\text{nV}/\sqrt{\text{Hz}}$ |
| | | | f = 10 kHz | | | 11.6 | | | |
| $V_{N(PP)}$ | Peak-to-peak equivalent input noise voltage | 25°C | f = 10 Hz to 10 kHz | | | 6 | | | μV |
| | | | f = 0.1 Hz to 10 Hz | | | 0.6 | | | |
| I_n | Equivalent input noise current $V_{IC} = 0$, f = 10 kHz | 25°C | 2.8 | | | 2.8 | | | $\text{fA}/\sqrt{\text{Hz}}$ |
| THD + N | Total harmonic distortion plus noise $V_{O(PP)} = 5\text{ V}$, f = 1 kHz, $R_S = 25\ \Omega$ | 25°C | 0.013% | | | 0.013% | | | |
| B_1 | Unity-gain bandwidth $V_I = 10\text{ mV}$, $C_L = 25\text{ pF}$, $R_L = 2\text{ k}\Omega$, See Figure 2 | 25°C | 9.4 | | | 9.4 | | | MHz |
| BOM | Maximum output-swing bandwidth $V_{O(PP)} = 4\text{ V}$, $R_L = 2\text{ k}\Omega$, $A_{VD} = -1$, $C_L = 25\text{ pF}$ | 25°C | 2.8 | | | 2.8 | | | MHz |
| ϕ_m | Phase margin at unity gain $V_I = 10\text{ mV}$, $C_L = 25\text{ pF}$, $R_L = 2\text{ k}\Omega$, See Figure 2 | 25°C | 56° | | | 56° | | | |

† Full range is 0°C to 70°C.



TLE208x, TLE208xA, TLE208xY
EXCALIBUR HIGH-SPEED JFET-INPUT
OPERATIONAL AMPLIFIERS

SLOS182B – FEBRUARY 1997 – REVISED JUNE 2001

TLE2084C electrical characteristics at specified free-air temperature, $V_{CC\pm} = \pm 15$ V (unless otherwise noted)

| PARAMETER | TEST CONDITIONS | T_A † | TLE2084C | | | TLE2084AC | | | UNIT | |
|---|--|----------------------------|-------------|-------------|-----|-------------|-------------|------------------|----------|----|
| | | | MIN | TYP | MAX | MIN | TYP | MAX | | |
| V_{IO} Input offset voltage | $V_{IC} = 0, V_O = 0, R_S = 50 \Omega$ | 25°C | -1.6 | 7 | | -0.5 | 4 | mV | | |
| | | Full range | | | 9.1 | | 6.1 | | | |
| α_{VIO} Temperature coefficient of input offset voltage | | Full range | 10.1 | 30 | | 10.1 | 30 | $\mu V/^\circ C$ | | |
| I_{IO} Input offset current | $V_{IC} = 0, V_O = 0, \text{See Figure 4}$ | 25°C | 15 | 100 | | 15 | 100 | pA | | |
| | | Full range | | | 1.4 | | 1.4 | nA | | |
| I_{IB} Input bias current | | 25°C | 25 | 175 | | 25 | 175 | pA | | |
| | | Full range | | | 5 | | 5 | nA | | |
| V_{ICR} Common-mode input voltage range | $R_S = 50 \Omega$ | 25°C | 15 to -11 | 15 to -11.9 | | 15 to -11 | 15 to -11.9 | V | | |
| | | Full range | 15 to -10.9 | | | 15 to -10.9 | | | | |
| V_{OM+} Maximum positive peak output voltage swing | $I_O = -200 \mu A$ | 25°C | 13.8 | 14.1 | | 13.8 | 14.1 | V | | |
| | | Full range | 13.7 | | | 13.7 | | | | |
| | $I_O = -2 \text{ mA}$ | 25°C | 13.5 | 13.9 | | 13.5 | 13.9 | | | |
| | | Full range | 13.4 | | | 13.4 | | | | |
| | $I_O = -20 \text{ mA}$ | 25°C | 11.5 | 12.3 | | 11.5 | 12.3 | | | |
| | | Full range | 11.5 | | | 11.5 | | | | |
| V_{OM-} Maximum negative peak output voltage swing | $I_O = 200 \mu A$ | 25°C | -13.8 | -14.2 | | -13.8 | -14.2 | V | | |
| | | Full range | -13.7 | | | -13.7 | | | | |
| | $I_O = 2 \text{ mA}$ | 25°C | -13.7 | -14 | | -13.7 | -14 | | | |
| | | Full range | -13.6 | | | -13.6 | | | | |
| | $I_O = 20 \text{ mA}$ | 25°C | -11.5 | -12.4 | | -11.5 | -12.4 | | | |
| | | Full range | -11.5 | | | -11.5 | | | | |
| A_{VD} Large-signal differential voltage amplification | $V_O = \pm 10 \text{ V}$ | $R_L = 600 \Omega$ | 25°C | 80 | 96 | | 80 | 96 | dB | |
| | | | Full range | 79 | | | 79 | | | |
| | | $R_L = 2 \text{ k}\Omega$ | 25°C | 90 | 109 | | 90 | 109 | | |
| | | | Full range | 89 | | | 89 | | | |
| | | $R_L = 10 \text{ k}\Omega$ | 25°C | 95 | 118 | | 95 | 118 | | |
| | | | Full range | 94 | | | 94 | | | |
| r_i Input resistance | $V_{IC} = 0$ | 25°C | 10^{12} | | | 10^{12} | | | Ω | |
| c_i Input capacitance | $V_{IC} = 0, \text{See Figure 5}$ | Common mode | 25°C | 7.5 | | | 7.5 | | | pF |
| | | Differential | 25°C | 2.5 | | | 2.5 | | | |
| z_o Open-loop output impedance | $f = 1 \text{ MHz}$ | 25°C | 80 | | | 80 | | | Ω | |
| CMRR Common-mode rejection ratio | $V_{IC} = V_{ICRmin}, V_O = 0, R_S = 50 \Omega$ | 25°C | 80 | 98 | | 80 | 98 | dB | | |
| | | Full range | 79 | | | 79 | | | | |
| k_{SVR} Supply-voltage rejection ratio ($\Delta V_{CC\pm}/\Delta V_{IO}$) | $V_{CC\pm} = \pm 5 \text{ V to } \pm 15 \text{ V}, V_O = 0, R_S = 50 \Omega$ | 25°C | 82 | 99 | | 82 | 99 | dB | | |
| | | Full range | 81 | | | 81 | | | | |
| I_{CC} Supply current (four amplifiers) | $V_O = 0, \text{No load}$ | 25°C | 5.2 | 6.5 | 7.5 | 5.2 | 6.5 | 7.5 | mA | |
| | | Full range | | | 7.5 | | | 7.5 | | |
| a_x Crosstalk attenuation | $V_{IC} = 0, R_L = 2 \text{ k}\Omega$ | 25°C | 120 | | | 120 | | | dB | |

† Full range is 0°C to 70°C.



TLE208x, TLE208xA, TLE208xY
EXCALIBUR HIGH-SPEED JFET-INPUT
OPERATIONAL AMPLIFIERS

SLOS182B – FEBRUARY 1997 – REVISED JUNE 2001

TLE2084C electrical characteristics at specified free-air temperature, $V_{CC\pm} = \pm 15\text{ V}$ (unless otherwise noted) (continued)

| PARAMETER | TEST CONDITIONS | T_A † | TLE2084C | | | TLE2084AC | | | UNIT |
|-----------|---|---------|------------------------|-----|-----|------------------------|-----|-----|------|
| | | | MIN | TYP | MAX | MIN | TYP | MAX | |
| I_{OS} | Short-circuit output current $V_O = 0$ | 25°C | $V_{ID} = 1\text{ V}$ | | | $V_{ID} = 1\text{ V}$ | | | mA |
| | | | $V_{ID} = -1\text{ V}$ | | | $V_{ID} = -1\text{ V}$ | | | |

† Full range is 0°C to 70°C.

TLE2084C operating characteristics at specified free-air temperature, $V_{CC\pm} = \pm 15\text{ V}$

| PARAMETER | TEST CONDITIONS | T_A † | TLE2084C | | | TLE2084AC | | | UNIT |
|-------------|---|---------|---------------------|-----|-----|-----------|-----|-----|--------|
| | | | MIN | TYP | MAX | MIN | TYP | MAX | |
| SR+ | Positive slew rate | 25°C | 25 | | | 25 | | | V/μs |
| | | | Full range | | | 22 | | | |
| SR- | Negative slew rate | 25°C | 30 | | | 30 | | | V/μs |
| | | | Full range | | | 25 | | | |
| t_s | Settling time | 25°C | To 10 mV | | | 0.4 | | | μs |
| | | | To 1 mV | | | 1.5 | | | |
| V_n | Equivalent input noise voltage | 25°C | f = 10 Hz | | | 28 | | | nV/√Hz |
| | | | f = 10 kHz | | | 11.6 | | | |
| $V_{N(PP)}$ | Peak-to-peak equivalent input noise voltage | 25°C | f = 10 Hz to 10 kHz | | | 6 | | | μV |
| | | | f = 0.1 Hz to 10 Hz | | | 0.6 | | | |
| I_n | Equivalent input noise current | 25°C | f = 10 kHz | | | 2.8 | | | fA/√Hz |
| THD + N | Total harmonic distortion plus noise | 25°C | 0.008% | | | 0.008% | | | |
| B_1 | Unity-gain bandwidth | 25°C | 8 | | | 8 | | | MHz |
| B_{OM} | Maximum output-swing bandwidth | 25°C | 478 | | | 478 | | | kHz |
| ϕ_m | Phase margin at unity gain | 25°C | 57° | | | 57° | | | |

† Full range is 0°C to 70°C.



TLE208x, TLE208xA, TLE208xY
EXCALIBUR HIGH-SPEED JFET-INPUT
OPERATIONAL AMPLIFIERS

SLOS182B – FEBRUARY 1997 – REVISED JUNE 2001

TLE2084M electrical characteristics at specified free-air temperature, $V_{CC\pm} = \pm 5\text{ V}$ (unless otherwise noted)

| PARAMETER | TEST CONDITIONS | T_A † | TLE2084M | | | TLE2084AM | | | UNIT | |
|---|---|----------------------------|------------|-----------|------|-----------|-----------|------------------------------|----------|----|
| | | | MIN | TYP | MAX | MIN | TYP | MAX | | |
| V_{IO} Input offset voltage | $V_{IC} = 0, V_O = 0, R_S = 50\ \Omega$ | 25°C | -1.6 | 7 | | -0.5 | 4 | mV | | |
| | | Full range | | | 12.5 | | 9.5 | | | |
| α_{VIO} Temperature coefficient of input offset voltage | | Full range | 10.1 | 30* | | 10.1 | 30* | $\mu\text{V}/^\circ\text{C}$ | | |
| I_{IO} Input offset current | $V_{IC} = 0, V_O = 0, \text{See Figure 4}$ | 25°C | 15 | 100 | | 15 | 100 | pA | | |
| | | Full range | | | 20 | | 20 | nA | | |
| I_{IB} Input bias current | | 25°C | 20 | 175 | | 20 | 175 | pA | | |
| | | Full range | | | 65 | | 65 | nA | | |
| V_{ICR} Common-mode input voltage range | $R_S = 50\ \Omega$ | 25°C | 5 to -1 | 5 to -1.9 | | 5 to -1 | 5 to -1.9 | V | | |
| | | Full range | 5 to -0.8 | | | 5 to -0.8 | | | | |
| V_{OM+} Maximum positive peak output voltage swing | $I_O = -200\ \mu\text{A}$ | 25°C | 3.8 | 4.1 | | 3.8 | 4.1 | V | | |
| | | Full range | 3.6 | | | 3.6 | | | | |
| | $I_O = -2\ \text{mA}$ | 25°C | 3.5 | 3.9 | | 3.5 | 3.9 | | | |
| | | Full range | 3.3 | | | 3.3 | | | | |
| | $I_O = -20\ \text{mA}$ | 25°C | 1.5 | 2.3 | | 1.5 | 2.3 | | | |
| | | Full range | 1.4 | | | 1.4 | | | | |
| V_{OM-} Maximum negative peak output voltage swing | $I_O = 200\ \mu\text{A}$ | 25°C | -3.8 | -4.2 | | -3.8 | -4.2 | V | | |
| | | Full range | -3.6 | | | -3.6 | | | | |
| | $I_O = 2\ \text{mA}$ | 25°C | -3.5 | -4.1 | | -3.5 | -4.1 | | | |
| | | Full range | -3.3 | | | -3.3 | | | | |
| | $I_O = 20\ \text{mA}$ | 25°C | -1.5 | -2.4 | | -1.5 | -2.4 | | | |
| | | Full range | -1.4 | | | -1.4 | | | | |
| A_{VD} Large-signal differential voltage amplification | $V_O = \pm 2.3\ \text{V}$ | $R_L = 600\ \Omega$ | 25°C | 80 | 91 | | 80 | 91 | dB | |
| | | | Full range | 78 | | | 78 | | | |
| | | $R_L = 2\ \text{k}\Omega$ | 25°C | 90 | 100 | | 90 | 100 | | |
| | | | Full range | 88 | | | 88 | | | |
| | | $R_L = 10\ \text{k}\Omega$ | 25°C | 95 | 106 | | 95 | 106 | | |
| | | | Full range | 93 | | | 93 | | | |
| r_i Input resistance | $V_{IC} = 0$ | 25°C | 10^{12} | | | 10^{12} | | | Ω | |
| c_i Input capacitance | $V_{IC} = 0, \text{See Figure 5}$ | Common mode | 25°C | 11 | | | 11 | | | pF |
| | | Differential | 25°C | 2.5 | | | 2.5 | | | |
| z_o Open-loop output impedance | $f = 1\ \text{MHz}$ | 25°C | 80 | | | 80 | | | Ω | |
| CMRR Common-mode rejection ratio | $V_{IC} = V_{ICR\text{min}}, V_O = 0, R_S = 50\ \Omega$ | 25°C | 70 | 89 | | 70 | 89 | dB | | |
| | | Full range | 68 | | | 68 | | | | |
| k_{SVR} Supply-voltage rejection ratio ($\Delta V_{CC\pm} / \Delta V_{IO}$) | $V_{CC\pm} = \pm 5\ \text{V to } \pm 15\ \text{V}, V_O = 0, R_S = 50\ \Omega$ | 25°C | 82 | 99 | | 82 | 99 | dB | | |
| | | Full range | 80 | | | 80 | | | | |
| I_{CC} Supply current (four amplifiers) | $V_O = 0, \text{No load}$ | 25°C | 5.2 | 6.3 | 7.5 | 5.2 | 6.3 | 7.5 | mA | |
| | | Full range | | | 7.5 | | | 7.5 | | |
| a_x Crosstalk attenuation | $V_{IC} = 0, R_L = 2\ \text{k}\Omega$ | 25°C | 120 | | | 120 | | | dB | |

*On products compliant with MIL-PRF-38535, Class B, this parameter is not production tested.

† Full range is -55°C to 125°C .



TLE208x, TLE208xA, TLE208xY
EXCALIBUR HIGH-SPEED JFET-INPUT
OPERATIONAL AMPLIFIERS

SLOS182B – FEBRUARY 1997 – REVISED JUNE 2001

TLE2084M electrical characteristics at specified free-air temperature, $V_{CC\pm} = \pm 5\text{ V}$ (unless otherwise noted) (continued)

| PARAMETER | TEST CONDITIONS | T_A | TLE2084M | | | TLE2084AM | | | UNIT | |
|-----------|------------------------------|-----------|------------------------|-----|-----|-----------|-----|-----|------|----|
| | | | MIN | TYP | MAX | MIN | TYP | MAX | | |
| I_{OS} | Short-circuit output current | $V_O = 0$ | $V_{ID} = 1\text{ V}$ | –35 | | | –35 | | | mA |
| | | | $V_{ID} = -1\text{ V}$ | 45 | | | 45 | | | |

TLE2084M operating characteristics at specified free-air temperature, $V_{CC\pm} = \pm 5\text{ V}$

| PARAMETER | TEST CONDITIONS | T_A † | TLE2084M | | | TLE2084AM | | | UNIT | |
|-------------|---|--|---------------------|--------|-----|-----------|--------|-----|------|------------------------|
| | | | MIN | TYP | MAX | MIN | TYP | MAX | | |
| SR+ | Positive slew rate | $V_{O(PP)} = \pm 2.3\text{ V}$, $A_{VD} = -1$, $R_L = 2\text{ k}\Omega$, $C_L = 100\text{ pF}$, See Figure 1 | 25°C | 35 | | | 35 | | | V/ μ s |
| | | | Full range | 18* | | | 18* | | | |
| SR– | Negative slew rate | $V_{O(PP)} = \pm 2.3\text{ V}$, $A_{VD} = -1$, $R_L = 2\text{ k}\Omega$, $C_L = 100\text{ pF}$, See Figure 1 | 25°C | 38 | | | 38 | | | V/ μ s |
| | | | Full range | 18* | | | 18* | | | |
| t_s | Settling time | $A_{VD} = -1$, 2-V step, $R_L = 1\text{ k}\Omega$, $C_L = 100\text{ pF}$ | To 10 mV | 0.25 | | | 0.25 | | | μ s |
| | | | To 1 mV | 0.4 | | | 0.4 | | | |
| V_n | Equivalent input noise voltage | $R_S = 20\ \Omega$, See Figure 3 | f = 10 Hz | 28 | | | 28 | | | nV/ $\sqrt{\text{Hz}}$ |
| | | | f = 10 kHz | 11.6 | | | 11.6 | | | |
| $V_{N(PP)}$ | Peak-to-peak equivalent input noise voltage | $R_S = 20\ \Omega$, See Figure 3 | f = 10 Hz to 10 kHz | 6 | | | 6 | | | μ V |
| | | | f = 0.1 Hz to 10 Hz | 0.6 | | | 0.6 | | | |
| I_n | Equivalent input noise current | $V_{IC} = 0$, f = 10 kHz | 25°C | 2.8 | | | 2.8 | | | fA/ $\sqrt{\text{Hz}}$ |
| THD + N | Total harmonic distortion plus noise | $V_{O(PP)} = 5\text{ V}$, $A_{VD} = 10$, f = 1 kHz, $R_L = 2\text{ k}\Omega$, $R_S = 25\ \Omega$ | 25°C | 0.013% | | | 0.013% | | | |
| B_1 | Unity-gain bandwidth | $V_I = 10\text{ mV}$, $R_L = 2\text{ k}\Omega$, $C_L = 25\text{ pF}$, See Figure 2 | 25°C | 9.4 | | | 9.4 | | | MHz |
| BOM | Maximum output-swing bandwidth | $V_{O(PP)} = 4\text{ V}$, $A_{VD} = -1$, $R_L = 2\text{ k}\Omega$, $C_L = 25\text{ pF}$ | 25°C | 2.8 | | | 2.8 | | | MHz |
| ϕ_m | Phase margin at unity gain | $V_I = 10\text{ mV}$, $R_L = 2\text{ k}\Omega$, $C_L = 25\text{ pF}$, See Figure 2 | 25°C | 56° | | | 56° | | | |

*On products compliant with MIL-PRF-38535, Class B, this parameter is not production tested.

† Full range is –55°C to 125°C.



TLE208x, TLE208xA, TLE208xY
EXCALIBUR HIGH-SPEED JFET-INPUT
OPERATIONAL AMPLIFIERS

SLOS182B – FEBRUARY 1997 – REVISED JUNE 2001

TLE2084M electrical characteristics at specified free-air temperature, $V_{CC\pm} = \pm 15$ V (unless otherwise noted)

| PARAMETER | TEST CONDITIONS | T_A † | TLE2084M | | | TLE2084AM | | | UNIT | |
|---|--|----------------------------|-------------|-------------|------|-------------|-------------|------------------|----------|----|
| | | | MIN | TYP | MAX | MIN | TYP | MAX | | |
| V_{IO} Input offset voltage | $V_{IC} = 0, V_O = 0, R_S = 50 \Omega$ | 25°C | -1.6 | 7 | | -0.5 | 4 | mV | | |
| | | Full range | | | 12.5 | | 7.5 | | | |
| α_{VIO} Temperature coefficient of input offset voltage | | Full range | 10.1 | 30* | | 10.1 | 30* | $\mu V/^\circ C$ | | |
| I_{IO} Input offset current | $V_{IC} = 0, V_O = 0, \text{See Figure 4}$ | 25°C | 15 | 100 | | 15 | 100 | pA | | |
| | | Full range | | | 20 | | 20 | nA | | |
| I_{IB} Input bias current | | 25°C | 25 | 175 | | 25 | 175 | pA | | |
| | | Full range | | | 65 | | 65 | nA | | |
| V_{ICR} Common-mode input voltage range | $R_S = 50 \Omega$ | 25°C | 15 to -11 | 15 to -11.9 | | 15 to -11 | 15 to -11.9 | V | | |
| | | Full range | 15 to -10.8 | | | 15 to -10.8 | | | | |
| V_{OM+} Maximum positive peak output voltage swing | $I_O = -200 \mu A$ | 25°C | 13.8 | 14.1 | | 13.8 | 14.1 | V | | |
| | | Full range | 13.6 | | | 13.6 | | | | |
| | $I_O = -2 \text{ mA}$ | 25°C | 13.5 | 13.9 | | 13.5 | 13.9 | | | |
| | | Full range | 13.3 | | | 13.3 | | | | |
| | $I_O = -20 \text{ mA}$ | 25°C | 11.5 | 12.3 | | 11.5 | 12.3 | | | |
| | | Full range | 11.4 | | | 11.4 | | | | |
| V_{OM-} Maximum negative peak output voltage swing | $I_O = 200 \mu A$ | 25°C | -13.8 | -14.2 | | -13.8 | -14.2 | V | | |
| | | Full range | -13.6 | | | -13.6 | | | | |
| | $I_O = 2 \text{ mA}$ | 25°C | -13.5 | -14 | | -13.5 | -14 | | | |
| | | Full range | -13.3 | | | -13.3 | | | | |
| | $I_O = 20 \text{ mA}$ | 25°C | -11.5 | -12.4 | | -11.5 | -12.4 | | | |
| | | Full range | -11.4 | | | -11.4 | | | | |
| A_{VD} Large-signal differential voltage amplification | $V_O = \pm 10 \text{ V}$ | $R_L = 600 \Omega$ | 25°C | 80 | 96 | | 80 | 96 | dB | |
| | | | Full range | 78 | | | 78 | | | |
| | | $R_L = 2 \text{ k}\Omega$ | 25°C | 90 | 109 | | 90 | 109 | | |
| | | | Full range | 88 | | | 88 | | | |
| | | $R_L = 10 \text{ k}\Omega$ | 25°C | 95 | 118 | | 95 | 118 | | |
| | | | Full range | 93 | | | 93 | | | |
| r_i Input resistance | $V_{IC} = 0$ | 25°C | 10^{12} | | | 10^{12} | | | Ω | |
| c_i Input capacitance | $V_{IC} = 0, \text{See Figure 5}$ | Common mode | 25°C | 7.5 | | | 7.5 | | | pF |
| | | Differential | 25°C | 2.5 | | | 2.5 | | | |
| z_o Open-loop output impedance | $f = 1 \text{ MHz}$ | 25°C | 80 | | | 80 | | | Ω | |
| CMRR Common-mode rejection ratio | $V_{IC} = V_{ICRmin}, V_O = 0, R_S = 50 \Omega$ | 25°C | 80 | 98 | | 80 | 98 | dB | | |
| | | Full range | 78 | | | 78 | | | | |
| k_{SVR} Supply-voltage rejection ratio ($\Delta V_{CC\pm}/\Delta V_{IO}$) | $V_{CC\pm} = \pm 5 \text{ V to } \pm 15 \text{ V}, V_O = 0, R_S = 50 \Omega$ | 25°C | 82 | 99 | | 82 | 99 | dB | | |
| | | Full range | 80 | | | 80 | | | | |
| I_{CC} Supply current (four amplifiers) | $V_O = 0, \text{No load}$ | 25°C | 5.2 | 6.5 | 7.5 | 5.2 | 6.5 | 7.5 | mA | |
| | | Full range | | | 7.5 | | | 7.5 | | |
| a_x Crosstalk attenuation | $V_{IC} = 0, R_L = 2 \text{ k}\Omega$ | 25°C | 120 | | | 120 | | | dB | |

*On products compliant with MIL-PRF-38535, Class B, this parameter is not production tested.

† Full range is $-55^\circ C$ to $125^\circ C$.



TLE208x, TLE208xA, TLE208xY
EXCALIBUR HIGH-SPEED JFET-INPUT
OPERATIONAL AMPLIFIERS

SLOS182B – FEBRUARY 1997 – REVISED JUNE 2001

TLE2084M electrical characteristics at specified free-air temperature, $V_{CC\pm} = \pm 15\text{ V}$ (unless otherwise noted) (continued)

| PARAMETER | TEST CONDITIONS | T_A | TLE2084M | | | TLE2084AM | | | UNIT |
|-----------|---|-------|-----------------------|-----|-----|------------------------|-----|-----|------|
| | | | MIN | TYP | MAX | MIN | TYP | MAX | |
| I_{OS} | Short-circuit output current $V_O = 0$ | 25°C | $V_{ID} = 1\text{ V}$ | | | $V_{ID} = -1\text{ V}$ | | | mA |
| | | | -30 | -45 | | -30 | -45 | | |
| | | | 30 | 48 | | 30 | 48 | | |

TLE2084M operating characteristics at specified free-air temperature, $V_{CC\pm} = \pm 15\text{ V}$

| PARAMETER | TEST CONDITIONS | T_A † | TLE2084M | | | TLE2084AM | | | UNIT |
|-------------|---|---------|---------------------|-----|-----|---------------------|-----|-----|------------------------------|
| | | | MIN | TYP | MAX | MIN | TYP | MAX | |
| SR+ | Positive slew rate | 25°C | Full range | | | Full range | | | $V/\mu\text{s}$ |
| | | | 25 | 40 | | 25 | 40 | | |
| SR- | Negative slew rate | 25°C | Full range | | | Full range | | | $V/\mu\text{s}$ |
| | | | 30 | 45 | | 30 | 45 | | |
| t_s | Settling time | 25°C | To 10 mV | | | To 10 mV | | | μs |
| | | | To 1 mV | | | To 1 mV | | | |
| V_n | Equivalent input noise voltage | 25°C | f = 10 Hz | | | f = 10 Hz | | | $\text{nV}/\sqrt{\text{Hz}}$ |
| | | | f = 10 kHz | | | f = 10 kHz | | | |
| $V_{N(PP)}$ | Peak-to-peak equivalent input noise voltage | 25°C | f = 10 Hz to 10 kHz | | | f = 10 Hz to 10 kHz | | | μV |
| | | | f = 0.1 Hz to 10 Hz | | | f = 0.1 Hz to 10 Hz | | | |
| I_n | Equivalent input noise current | 25°C | f = 10 kHz | | | f = 10 kHz | | | $\text{fA}/\sqrt{\text{Hz}}$ |
| THD + N | Total harmonic distortion plus noise | 25°C | 0.008% | | | 0.008% | | | |
| B_1 | Unity-gain bandwidth | 25°C | 8* | 10 | | 8* | 10 | MHz | |
| B_{OM} | Maximum output-swing bandwidth | 25°C | 478* | 637 | | 478* | 637 | kHz | |
| ϕ_m | Phase margin at unity gain | 25°C | 57° | | | 57° | | | |

*On products compliant with MIL-PRF-38535, Class B, this parameter is not production tested.

† Full range is -55°C to 125°C.



TLE208x, TLE208xA, TLE208xY
EXCALIBUR HIGH-SPEED JFET-INPUT
OPERATIONAL AMPLIFIERS

SLOS182B – FEBRUARY 1997 – REVISED JUNE 2001

TLE2084Y electrical characteristics at $V_{CC\pm} = \pm 15\text{ V}$, $T_A = 25^\circ\text{C}$ (unless otherwise noted)

| PARAMETER | | TEST CONDITIONS | | TLE2084Y | | | UNIT |
|-----------|---|---|----------------------------|------------------|------------------|-----|----------|
| | | | | MIN | TYP | MAX | |
| V_{IO} | Input offset voltage | $V_{IC} = 0$, $R_S = 50\ \Omega$ | $V_O = 0$, | | | 7 | mV |
| I_{IO} | Input offset current | $V_{IC} = 0$, | $V_O = 0$, | | 15 | 100 | pA |
| I_{IB} | Input bias current | See Figure 4 | | | 25 | 175 | pA |
| V_{ICR} | Common-mode input voltage range | $R_S = 50\ \Omega$ | | 15 to -11 | 15 to 11.9 | | V |
| V_{OM+} | Maximum positive peak output voltage swing | $I_O = -200\ \mu\text{A}$ | | 13.8 | 14.1 | | V |
| | | $I_O = -2\ \text{mA}$ | | 13.5 | 13.9 | | |
| | | $I_O = -20\ \text{mA}$ | | 11.5 | 12.3 | | |
| V_{OM-} | Maximum negative peak output voltage swing | $I_O = 200\ \mu\text{A}$ | | -13.8 | -14.2 | | V |
| | | $I_O = 2\ \text{mA}$ | | -13.5 | -14 | | |
| | | $I_O = 20\ \text{mA}$ | | -11.5 | -12.4 | | |
| A_{VD} | Large-signal differential voltage amplification | $V_O = \pm 10\ \text{V}$ | $R_L = 600\ \Omega$ | 80 | 96 | | dB |
| | | | $R_L = 2\ \text{k}\Omega$ | 90 | 109 | | |
| | | | $R_L = 10\ \text{k}\Omega$ | 95 | 118 | | |
| r_i | Input resistance | $V_{IC} = 0$ | | 10 ¹² | | | Ω |
| c_i | Input capacitance | $V_{IC} = 0$, See Figure 5 | Common mode | 7.5 | | | pF |
| | | | Differential | 2.5 | | | |
| z_o | Open-loop output impedance | $f = 1\ \text{MHz}$ | | 80 | | | Ω |
| CMRR | Common-mode rejection ratio | $V_{IC} = V_{ICRmin}$, $R_S = 50\ \Omega$ | $V_O = 0$, | 80 | 98 | | dB |
| k_{SVR} | Supply-voltage rejection ratio ($\Delta V_{CC\pm} / \Delta V_{IO}$) | $V_{CC\pm} = \pm 5\ \text{V}$ to $\pm 15\ \text{V}$, $V_O = 0$, $R_S = 50\ \Omega$ | | 82 | 99 | | dB |
| I_{CC} | Supply current (four amplifiers) | $V_O = 0$, | No load | 5.2 | 6.5 | 7.5 | mA |
| I_{OS} | Short-circuit output current | $V_O = 0$ | $V_{ID} = 1\ \text{V}$ | -30 | -45 | | mA |
| | | | $V_{ID} = -1\ \text{V}$ | 30 | 48 | | |

TLE208x, TLE208xA, TLE208xY EXCALIBUR HIGH-SPEED JFET-INPUT OPERATIONAL AMPLIFIERS

SLOS182B – FEBRUARY 1997 – REVISED JUNE 2001

PARAMETER MEASUREMENT INFORMATION

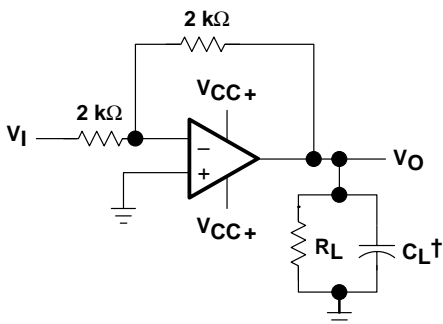

† Includes fixture capacitance

Figure 1. Slew-Rate Test Circuit



† Includes fixture capacitance

Figure 2. Unity-Gain Bandwidth and Phase-Margin Test Circuit

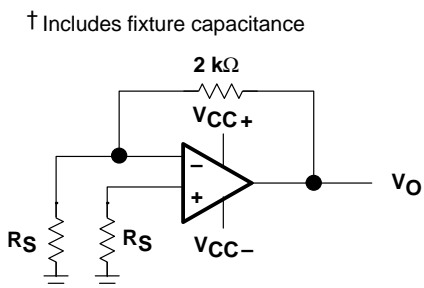

† Includes fixture capacitance

Figure 3. Noise-Voltage Test Circuit

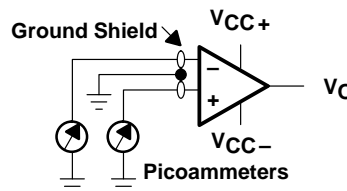

Figure 4. Input-Bias and Offset-Current Test Circuit

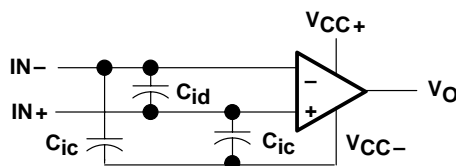

Figure 5. Internal Input Capacitance

typical values

Typical values presented in this data sheet represent the median (50% point) of device parametric performance.

input bias and offset current

At the picoampere bias-current level typical of the TLE208x and TLE208xA, accurate measurement of the bias becomes difficult. Not only does this measurement require a picoammeter, but test socket leakages can easily exceed the actual device bias currents. To accurately measure these small currents, Texas Instruments uses a two-step process. The socket leakage is measured using picoammeters with bias voltages applied but with no device in the socket. The device is then inserted in the socket and a second test is performed that measures both the socket leakage and the device input bias current. The two measurements are then subtracted algebraically to determine the bias current of the device.

TYPICAL CHARACTERISTICS

Table of Graphs

| | | | FIGURE |
|----------------|---|--|-------------------------------------|
| V_{IO} | Input offset voltage | Distribution | 6, 7, 8 |
| α_{VIO} | Input offset voltage temperature coefficient | Distribution | 9, 10, 11 |
| I_{IO} | Input offset current | vs Free-air temperature | 12 – 15 |
| I_{IB} | Input bias current | vs Free-air temperature vs Supply voltage | 12 – 15 16 |
| V_{ICR} | Common-mode input voltage range | vs Free-air temperature | 17 |
| V_{ID} | Differential input voltage | vs Output voltage | 18, 19 |
| V_{OM+} | Maximum positive peak output voltage | vs Output current vs Free-air temperature vs Supply voltage | 20, 21 24, 25 26 |
| V_{OM-} | Maximum negative peak output voltage | vs Output current vs Free-air temperature vs Supply voltage | 22, 23 24, 25 26 |
| $V_{O(PP)}$ | Maximum peak-to-peak output voltage | vs Frequency | 27 |
| V_O | Output voltage | vs Settling time | 28 |
| A_{VD} | Large-signal differential voltage amplification | vs Load resistance vs Free-air temperature | 29 30, 31 |
| A_{VD} | Small-signal differential voltage amplification | vs Frequency | 32, 33 |
| $CMRR$ | Common-mode rejection ratio | vs Frequency vs Free-air temperature | 34 35 |
| k_{SVR} | Supply-voltage rejection ratio | vs Frequency vs Free-air temperature | 36 37 |
| I_{CC} | Supply current | vs Supply voltage vs Free-air temperature vs Differential input voltage | 38, 39, 40 41, 42, 43 44 – 49 |
| I_{OS} | Short-circuit output current | vs Supply voltage vs Elapsed time vs Free-air temperature | 50 51 52 |
| SR | Slew rate | vs Free-air temperature vs Load resistance vs Differential input voltage | 53, 54 55 56 |
| V_n | Equivalent input noise voltage | vs Frequency | 57 |
| V_n | Input-referred noise voltage | vs Noise bandwidth frequency Over a 10-second time interval | 58 59 |
| | Third-octave spectral noise density | vs Frequency bands | 60 |
| $THD + N$ | Total harmonic distortion plus noise | vs Frequency | 61, 62 |
| B_1 | Unity-gain bandwidth | vs Load capacitance | 63 |
| | Gain-bandwidth product | vs Free-air temperature vs Supply voltage | 64 65 |
| | Gain margin | vs Load capacitance | 66 |
| ϕ_m | Phase margin | vs Free-air temperature vs Supply voltage vs Load capacitance | 67 68 69 |
| | Phase shift | vs Frequency | 32, 33 |

TLE208x, TLE208xA, TLE208xY
EXCALIBUR HIGH-SPEED JFET-INPUT
OPERATIONAL AMPLIFIERS

SLOS182B – FEBRUARY 1997 – REVISED JUNE 2001

TYPICAL CHARACTERISTICS

Table of Graphs (Continued)

| | | FIGURE |
|--|---|--------|
| Noninverting large-signal pulse response | vs Time | 70 |
| Small-signal pulse response | vs Time | 71 |
| z_o | Closed-loop output impedance vs Frequency | 72 |
| a_x | Crosstalk attenuation vs Frequency | 73 |

**DISTRIBUTION OF TLE2081
INPUT OFFSET VOLTAGE**

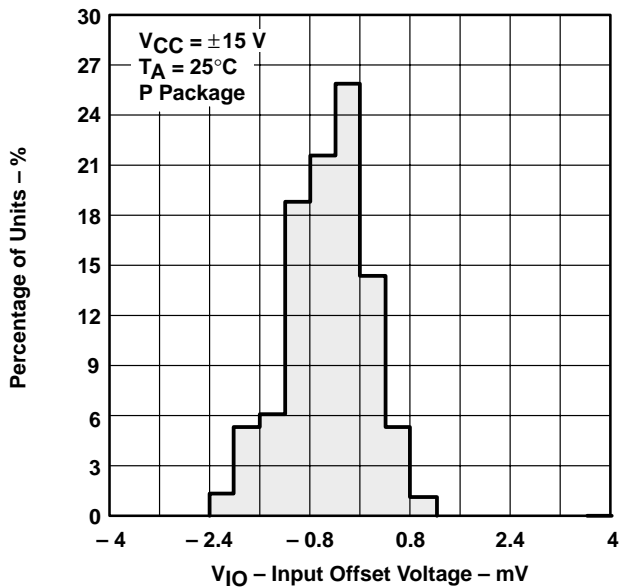

Figure 6

**DISTRIBUTION OF TLE2082
INPUT OFFSET VOLTAGE**

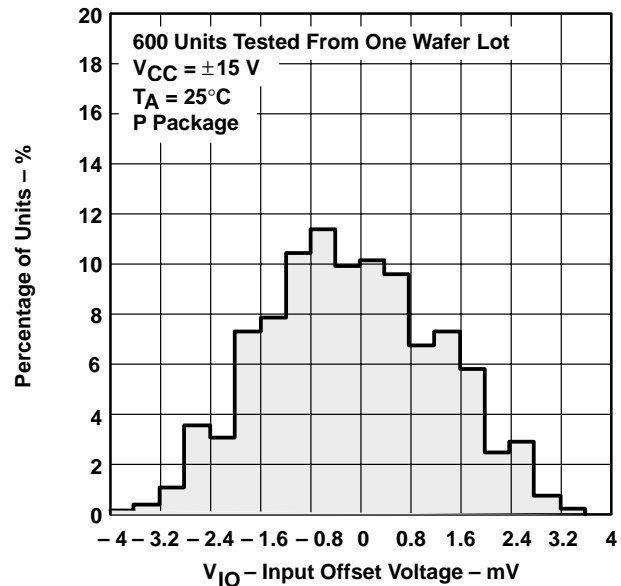

Figure 7

TYPICAL CHARACTERISTICS

DISTRIBUTION OF TLE2084
INPUT OFFSET VOLTAGE



Figure 8

DISTRIBUTION OF TLE2081 INPUT OFFSET
VOLTAGE TEMPERATURE COEFFICIENT



Figure 9

DISTRIBUTION OF TLE2082 INPUT OFFSET
VOLTAGE TEMPERATURE COEFFICIENT

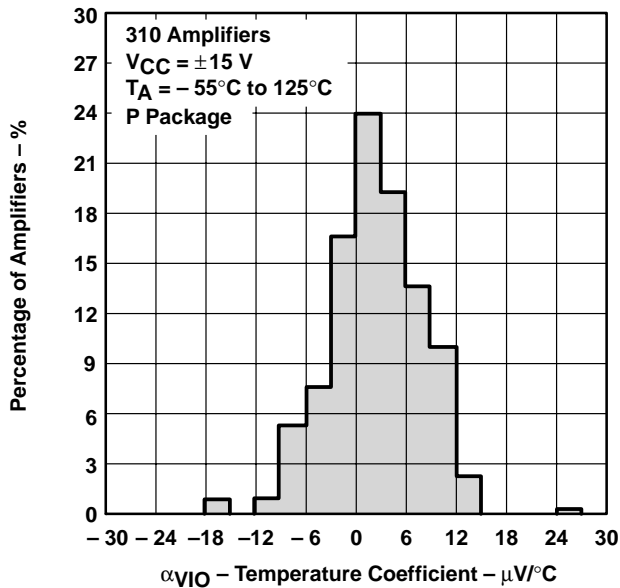

Figure 10

DISTRIBUTION OF TLE2084 INPUT OFFSET
VOLTAGE TEMPERATURE COEFFICIENT



Figure 11

TLE208x, TLE208xA, TLE208xY
EXCALIBUR HIGH-SPEED JFET-INPUT
OPERATIONAL AMPLIFIERS

SLOS182B – FEBRUARY 1997 – REVISED JUNE 2001

TYPICAL CHARACTERISTICS†

TLE2081 AND TLE2082
INPUT BIAS CURRENT AND INPUT OFFSET CURRENT
vs
FREE-AIR TEMPERATURE

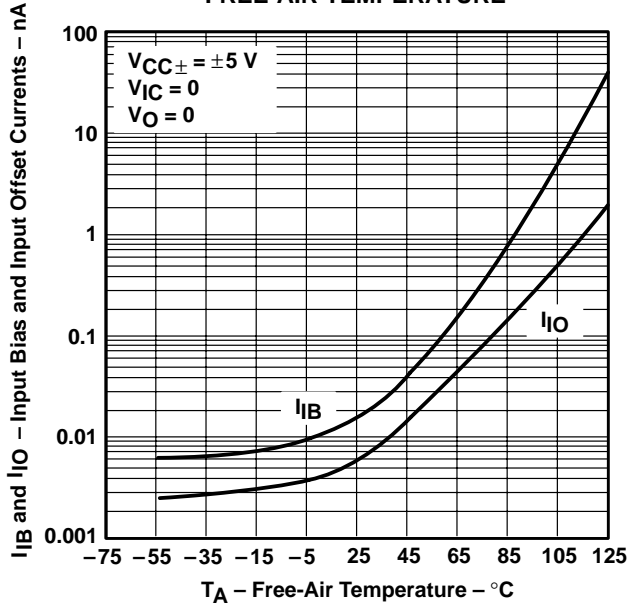

Figure 12

TLE2084
INPUT BIAS CURRENT AND INPUT OFFSET CURRENT
vs
FREE-AIR TEMPERATURE

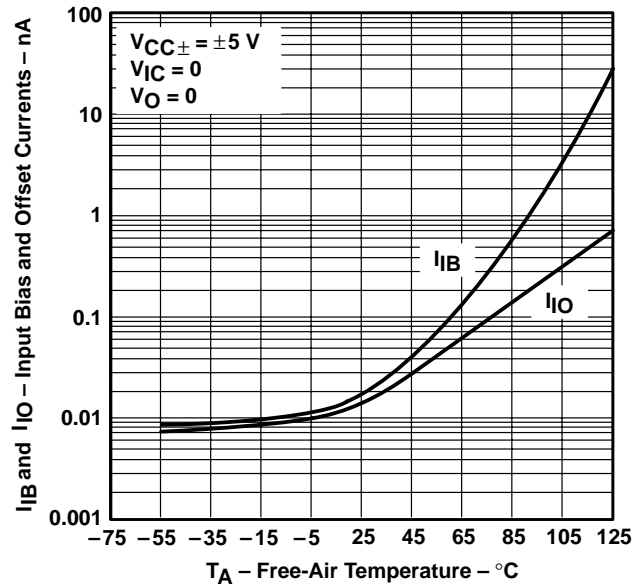

Figure 13

TLE2081 AND TLE2082
INPUT BIAS CURRENT AND INPUT OFFSET CURRENT
vs
FREE-AIR TEMPERATURE

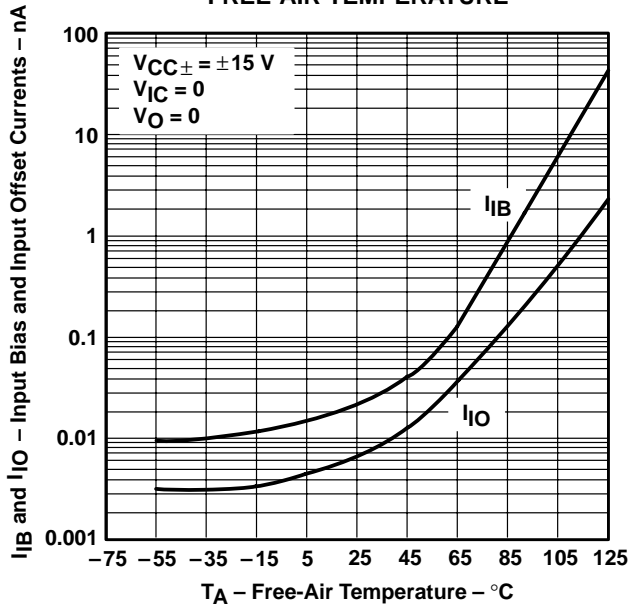

Figure 14

TLE2084
INPUT BIAS CURRENT AND INPUT OFFSET CURRENT
vs
FREE-AIR TEMPERATURE

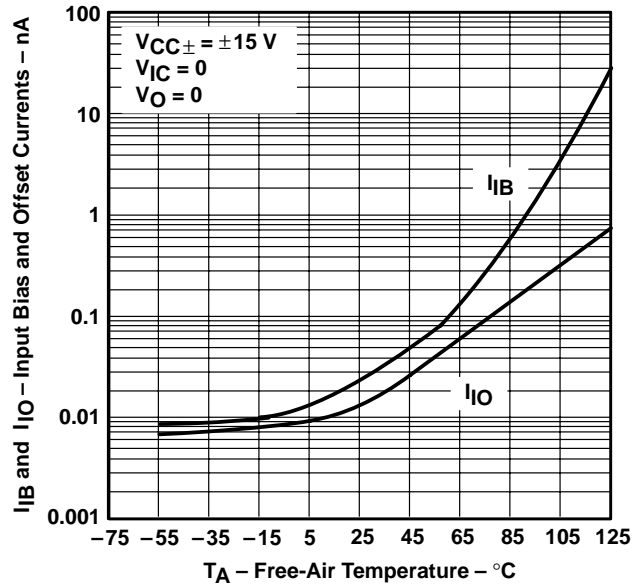
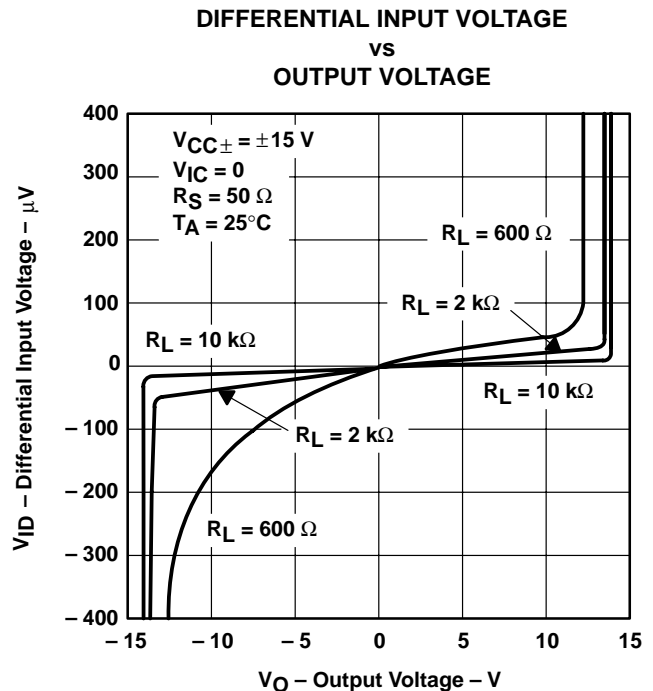
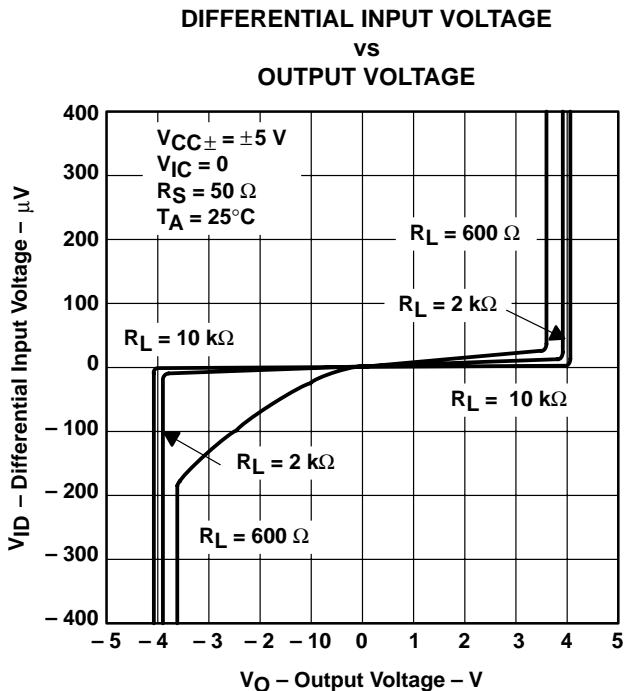
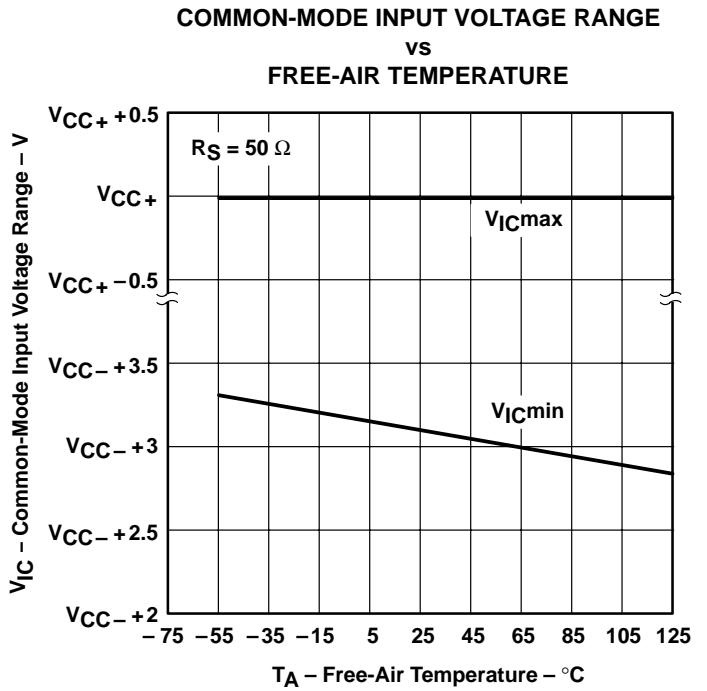
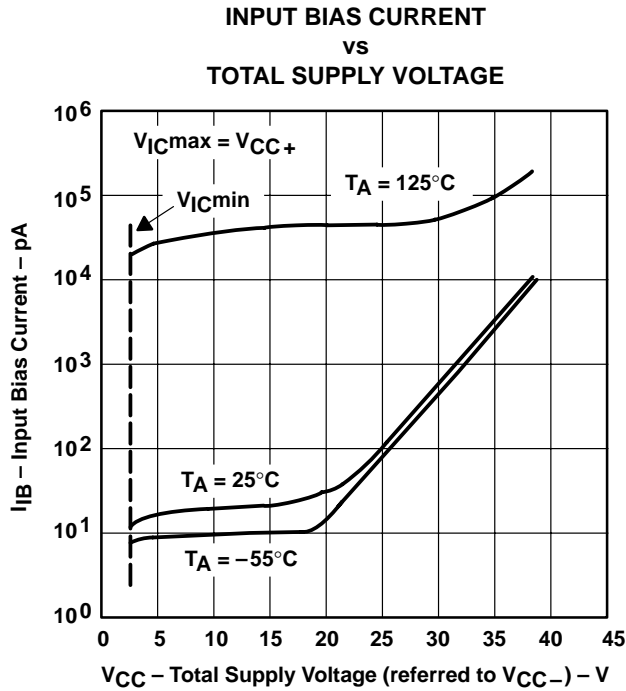

Figure 15

† Data at high and low temperatures are applicable only within the rated operating free-air temperature ranges of the various devices.

TYPICAL CHARACTERISTICS†



† Data at high and low temperatures are applicable only within the rated operating free-air temperature ranges of the various devices.

TLE208x, TLE208xA, TLE208xY EXCALIBUR HIGH-SPEED JFET-INPUT OPERATIONAL AMPLIFIERS

SLOS182B – FEBRUARY 1997 – REVISED JUNE 2001

TYPICAL CHARACTERISTICS†

**TLE2081 AND TLE2082
MAXIMUM POSITIVE PEAK OUTPUT VOLTAGE
vs
OUTPUT CURRENT**

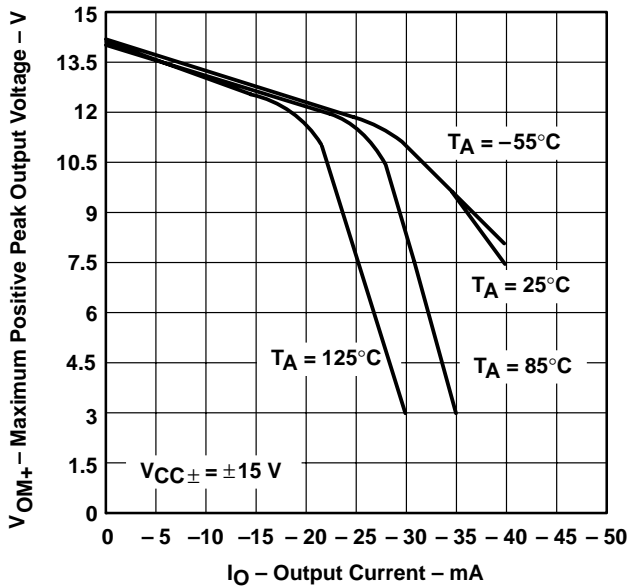

Figure 20

**TLE2084
MAXIMUM POSITIVE PEAK OUTPUT VOLTAGE
vs
OUTPUT CURRENT**

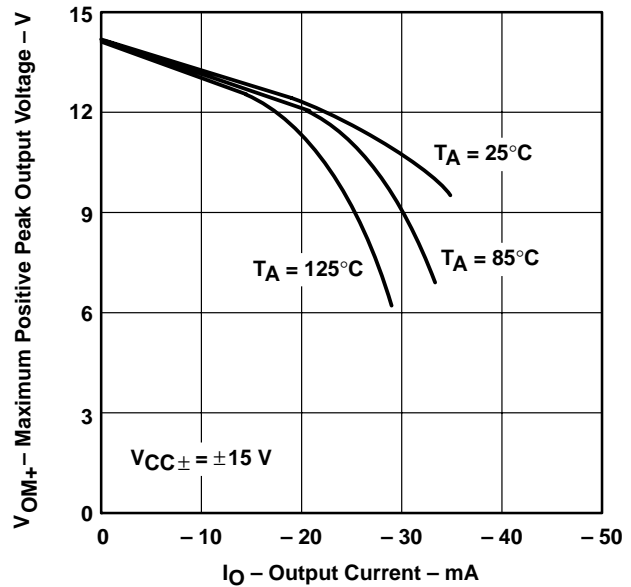

Figure 21

**TLE2081 AND TLE2082
MAXIMUM NEGATIVE PEAK OUTPUT VOLTAGE
vs
OUTPUT CURRENT**

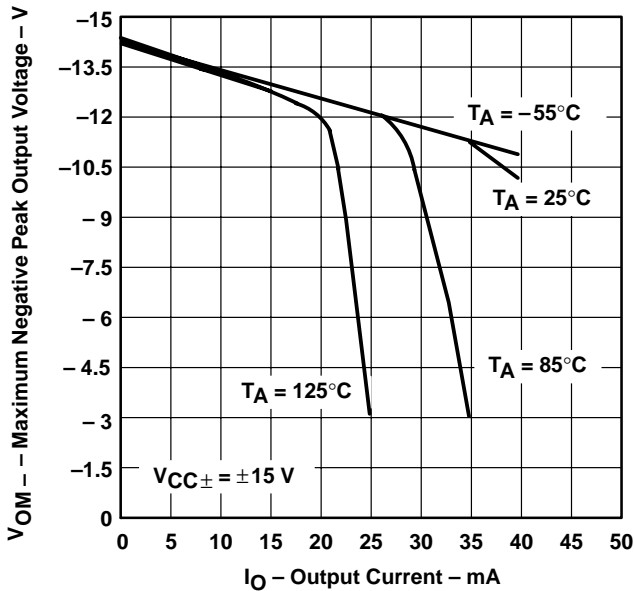

Figure 22

**TLE2084
MAXIMUM NEGATIVE PEAK OUTPUT VOLTAGE
vs
OUTPUT CURRENT**

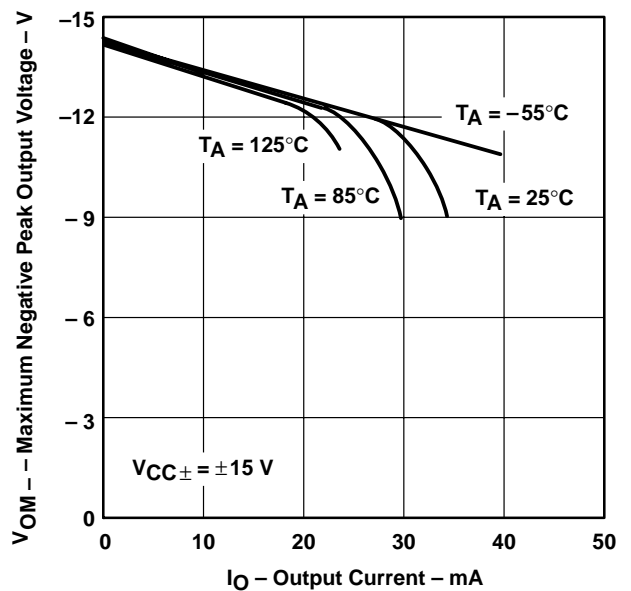

Figure 23

† Data at high and low temperatures are applicable only within the rated operating free-air temperature ranges of the various devices.



TYPICAL CHARACTERISTICS†

MAXIMUM PEAK OUTPUT VOLTAGE
vs
FREE-AIR TEMPERATURE

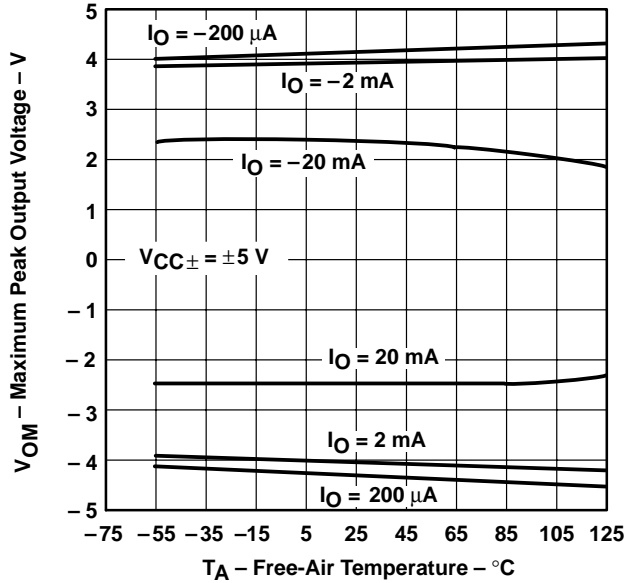

Figure 24

MAXIMUM PEAK OUTPUT VOLTAGE
vs
FREE-AIR TEMPERATURE

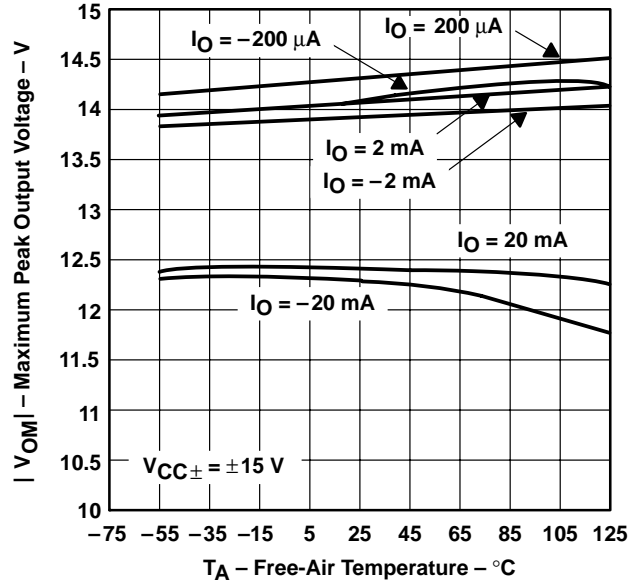

Figure 25

MAXIMUM PEAK OUTPUT VOLTAGE
vs
SUPPLY VOLTAGE



Figure 26

MAXIMUM PEAK-TO-PEAK OUTPUT VOLTAGE
vs
FREQUENCY

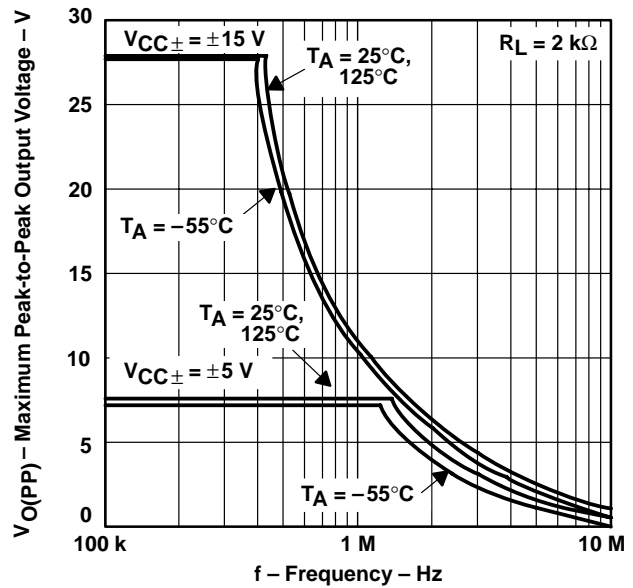

Figure 27

† Data at high and low temperatures are applicable only within the rated operating free-air temperature ranges of the various devices.

TLE208x, TLE208xA, TLE208xY EXCALIBUR HIGH-SPEED JFET-INPUT OPERATIONAL AMPLIFIERS

SLOS182B – FEBRUARY 1997 – REVISED JUNE 2001

TYPICAL CHARACTERISTICS†

OUTPUT VOLTAGE
vs
SETTLING TIME

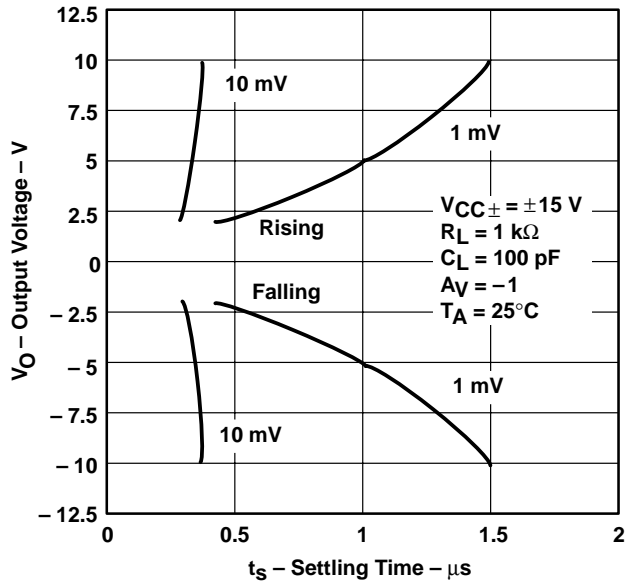

Figure 28

LARGE-SIGNAL DIFFERENTIAL
VOLTAGE AMPLIFICATION
vs
LOAD RESISTANCE

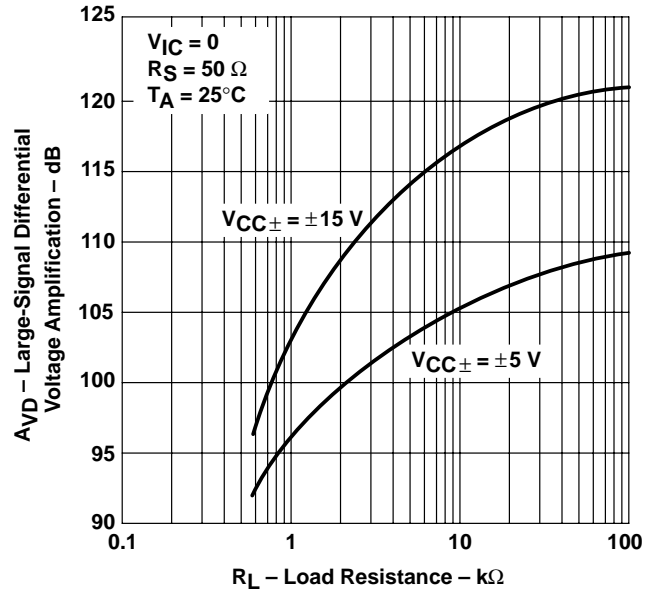

Figure 29

LARGE-SIGNAL DIFFERENTIAL
VOLTAGE AMPLIFICATION
vs
FREE-AIR TEMPERATURE

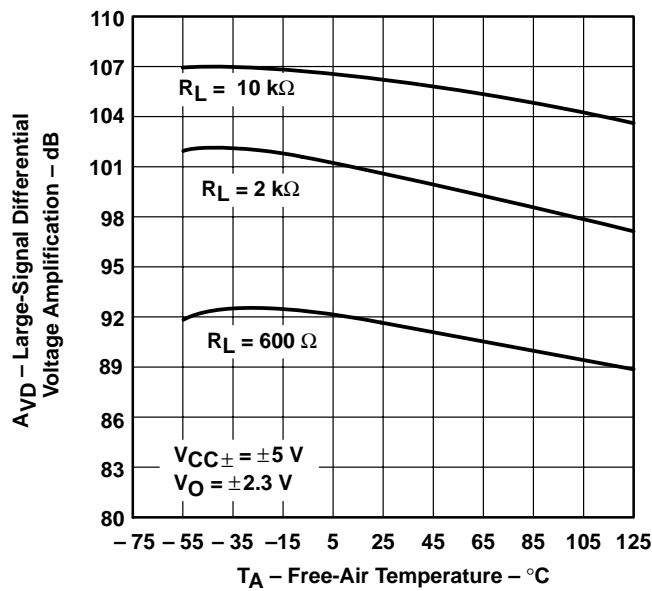

Figure 30

LARGE-SIGNAL DIFFERENTIAL
VOLTAGE AMPLIFICATION
vs
FREE-AIR TEMPERATURE

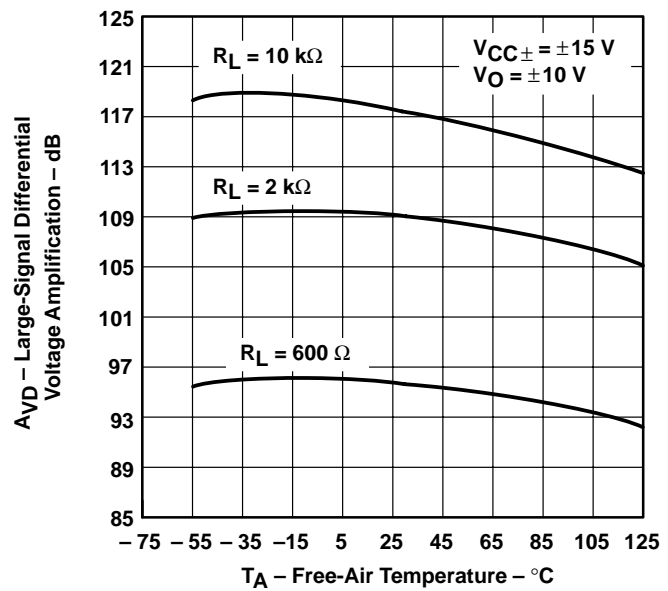

Figure 31

† Data at high and low temperatures are applicable only within the rated operating free-air temperature ranges of the various devices.

TYPICAL CHARACTERISTICS

SMALL-SIGNAL DIFFERENTIAL VOLTAGE
 AMPLIFICATION AND PHASE SHIFT
 vs
 FREQUENCY

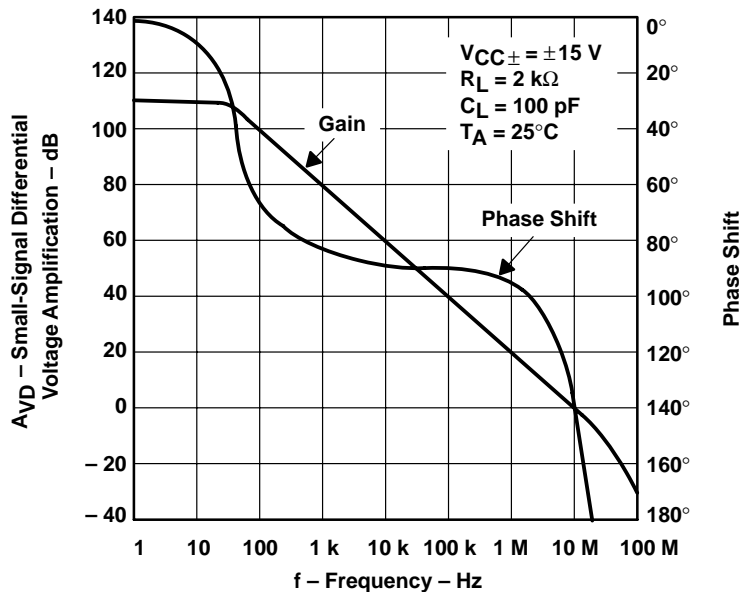

Figure 32

SMALL-SIGNAL DIFFERENTIAL VOLTAGE
 AMPLIFICATION AND PHASE SHIFT
 vs
 FREQUENCY

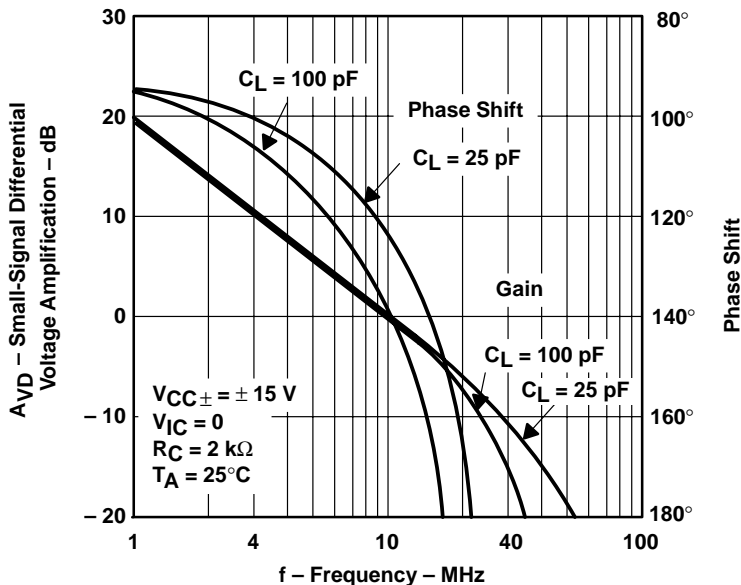

Figure 33

TLE208x, TLE208xA, TLE208xY EXCALIBUR HIGH-SPEED JFET-INPUT OPERATIONAL AMPLIFIERS

SLOS182B – FEBRUARY 1997 – REVISED JUNE 2001

TYPICAL CHARACTERISTICS†



Figure 34



Figure 35



Figure 36



Figure 37

† Data at high and low temperatures are applicable only within the rated operating free-air temperature ranges of the various devices.

TYPICAL CHARACTERISTICS†



† Data at high and low temperatures are applicable only within the rated operating free-air temperature ranges of the various devices.

TLE208x, TLE208xA, TLE208xY EXCALIBUR HIGH-SPEED JFET-INPUT OPERATIONAL AMPLIFIERS

SLOS182B – FEBRUARY 1997 – REVISED JUNE 2001

TYPICAL CHARACTERISTICS†

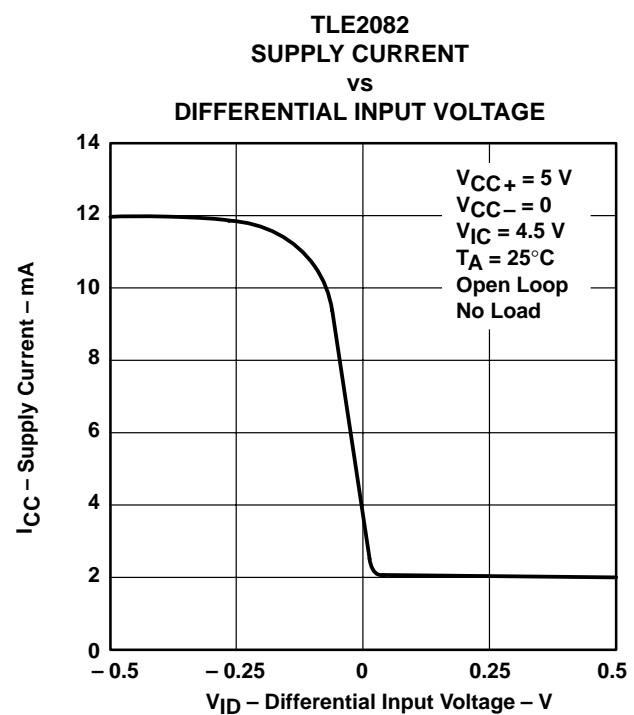
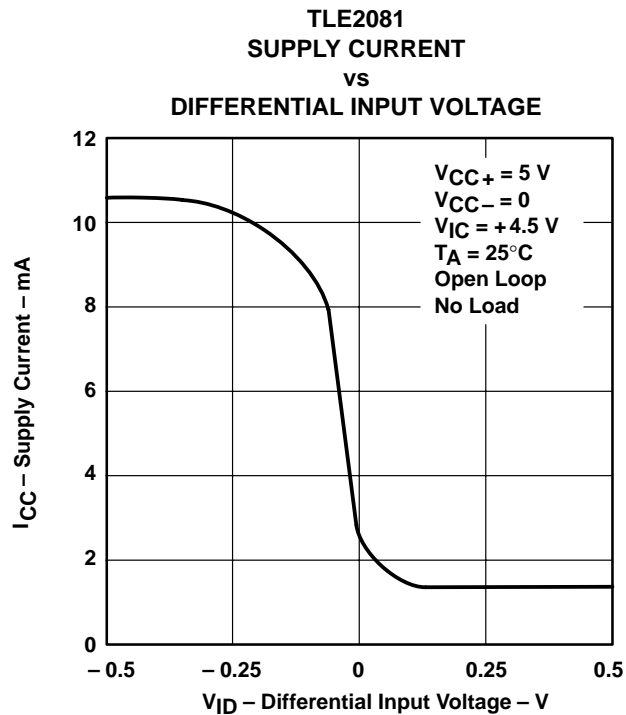
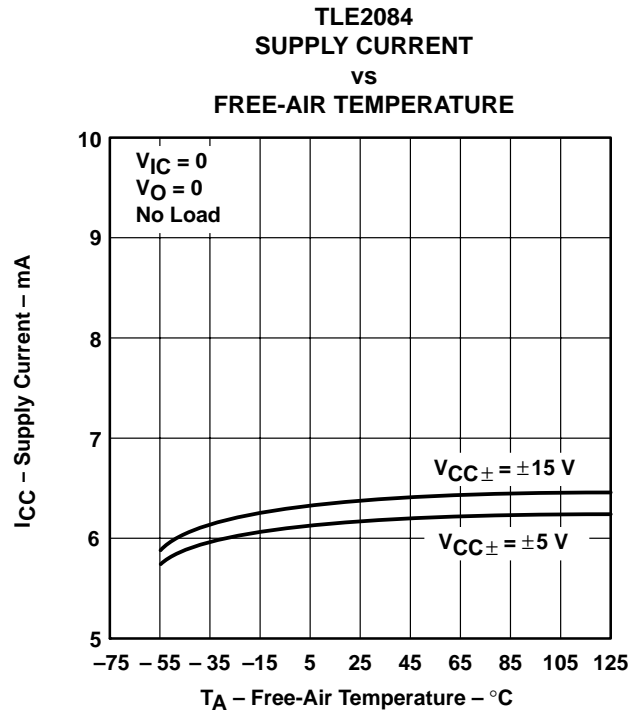

† Data at high and low temperatures are applicable only within the rated operating free-air temperature ranges of the various devices.

TYPICAL CHARACTERISTICS

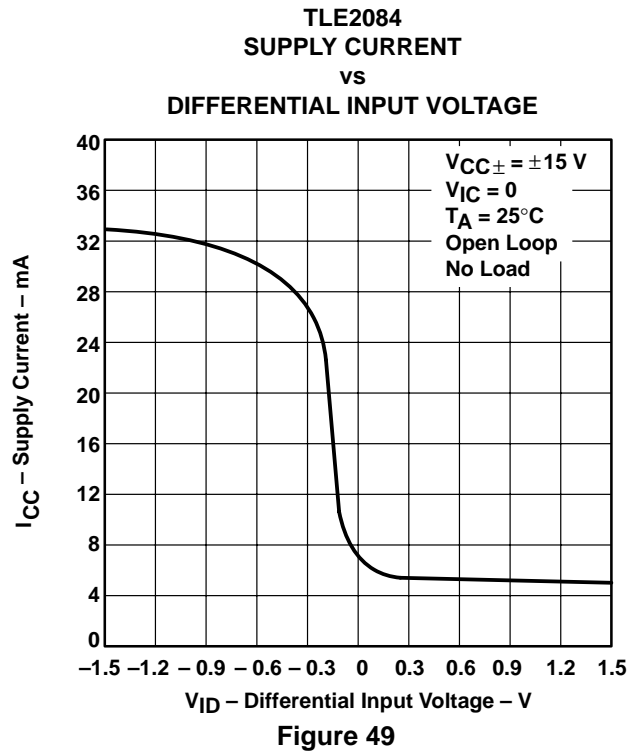
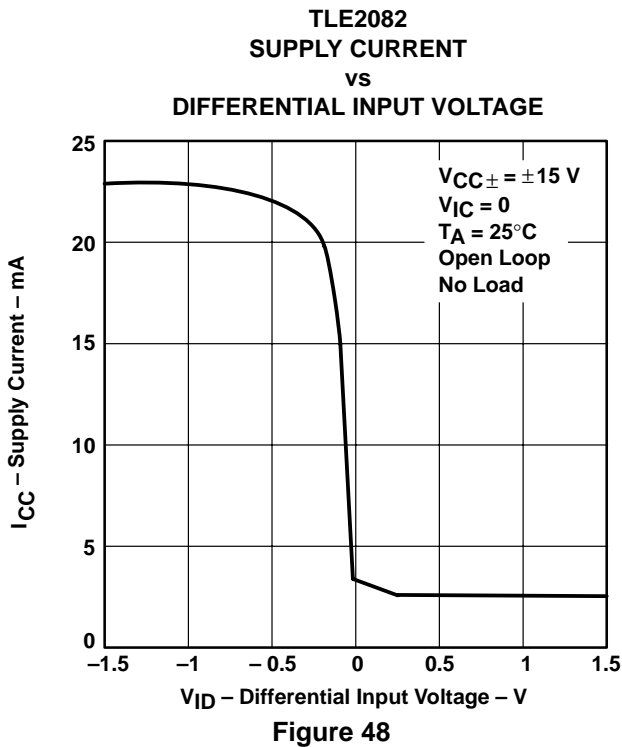
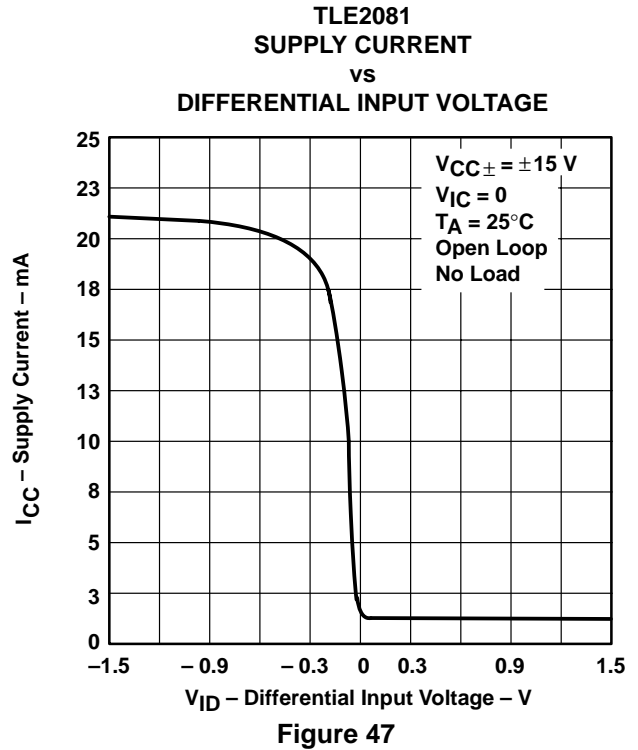

TLE208x, TLE208xA, TLE208xY EXCALIBUR HIGH-SPEED JFET-INPUT OPERATIONAL AMPLIFIERS

SLOS182B – FEBRUARY 1997 – REVISED JUNE 2001

TYPICAL CHARACTERISTICS†

SHORT-CIRCUIT OUTPUT CURRENT
vs
SUPPLY VOLTAGE

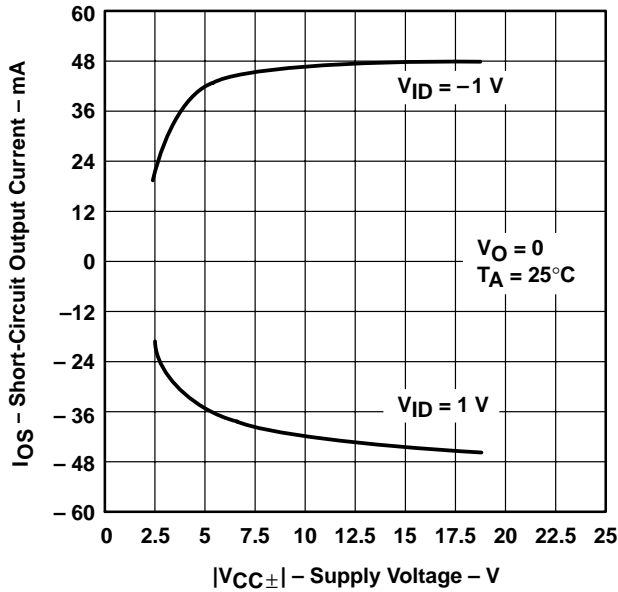

Figure 50

SHORT-CIRCUIT OUTPUT CURRENT
vs
ELAPSED TIME

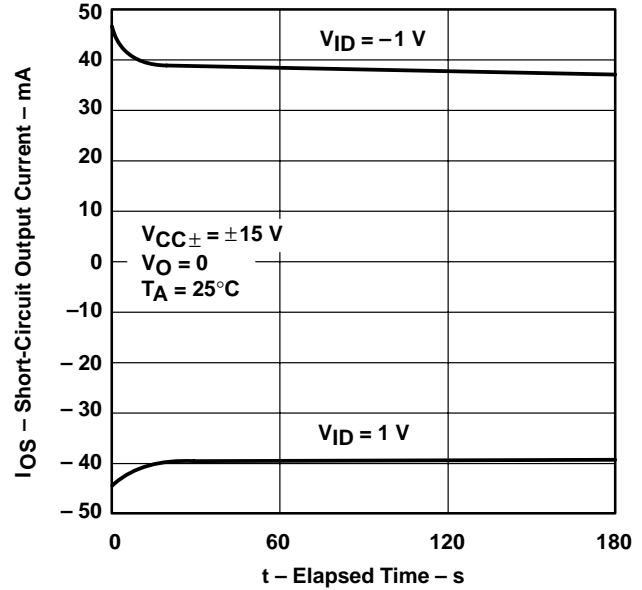

Figure 51

SHORT-CIRCUIT OUTPUT CURRENT
vs
FREE-AIR TEMPERATURE

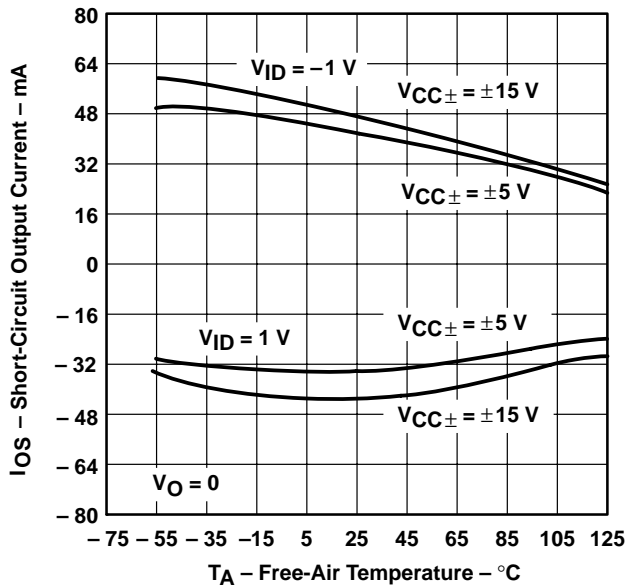

Figure 52

SLEW RATE
vs
FREE-AIR TEMPERATURE

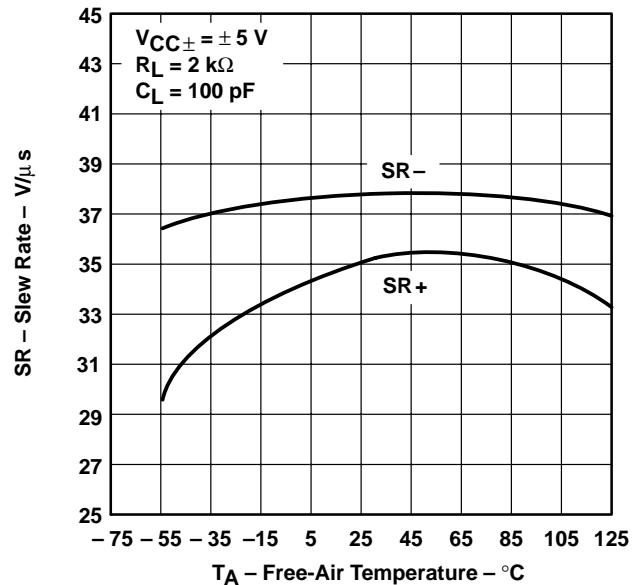

Figure 53

† Data at high and low temperatures are applicable only within the rated operating free-air temperature ranges of the various devices.

TYPICAL CHARACTERISTICS†

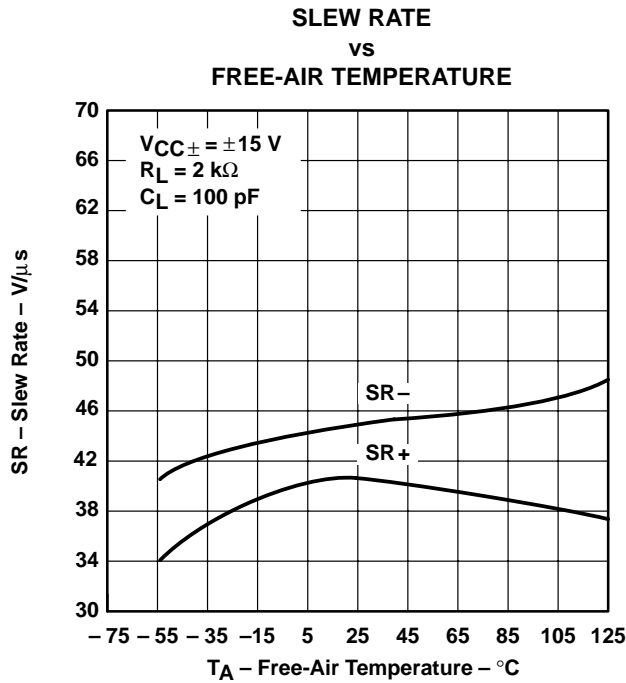

Figure 54

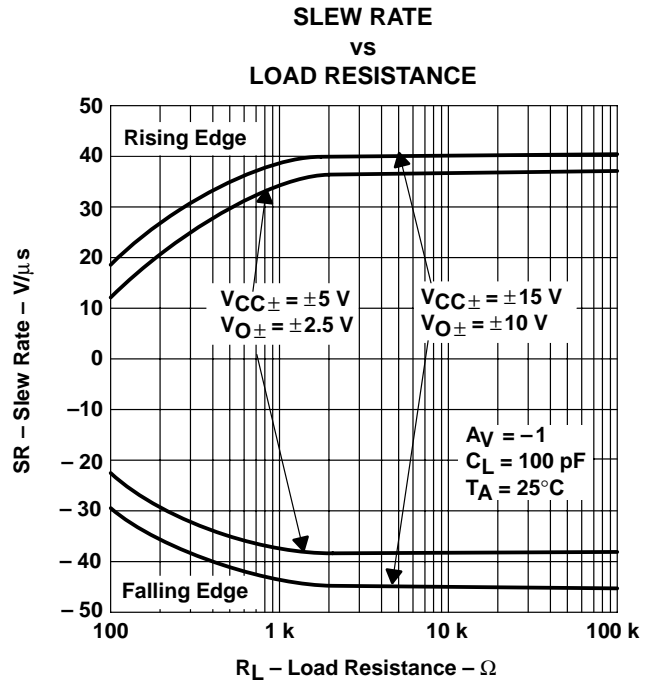

Figure 55

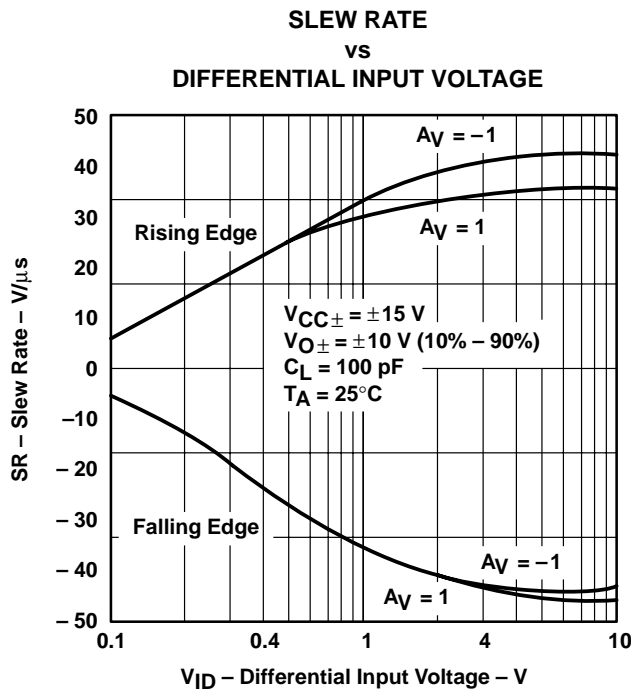

Figure 56

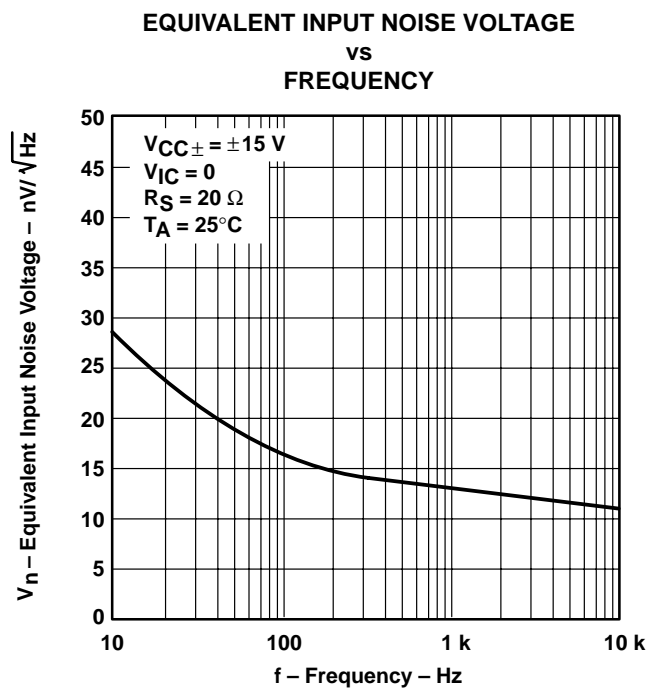

Figure 57

† Data at high and low temperatures are applicable only within the rated operating free-air temperature ranges of the various devices.

TLE208x, TLE208xA, TLE208xY
EXCALIBUR HIGH-SPEED JFET-INPUT
OPERATIONAL AMPLIFIERS

SLOS182B – FEBRUARY 1997 – REVISED JUNE 2001

TYPICAL CHARACTERISTICS

INPUT-REFERRED NOISE VOLTAGE
vs
NOISE BANDWIDTH FREQUENCY

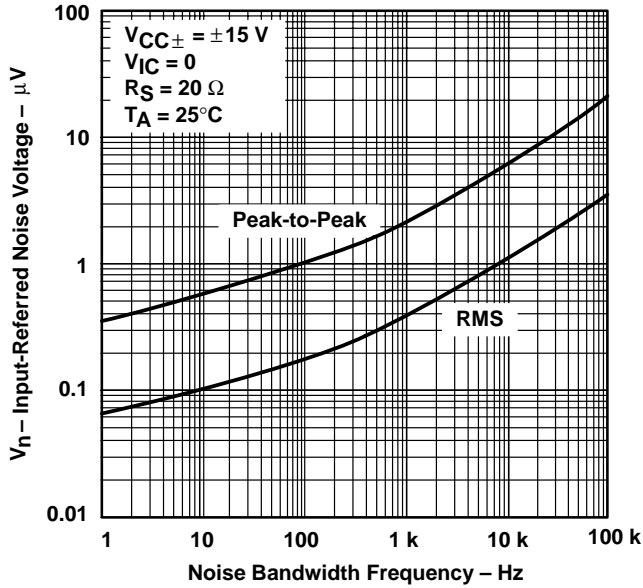

Figure 58

INPUT-REFERRED NOISE VOLTAGE
OVER A 10-SECOND TIME INTERVAL

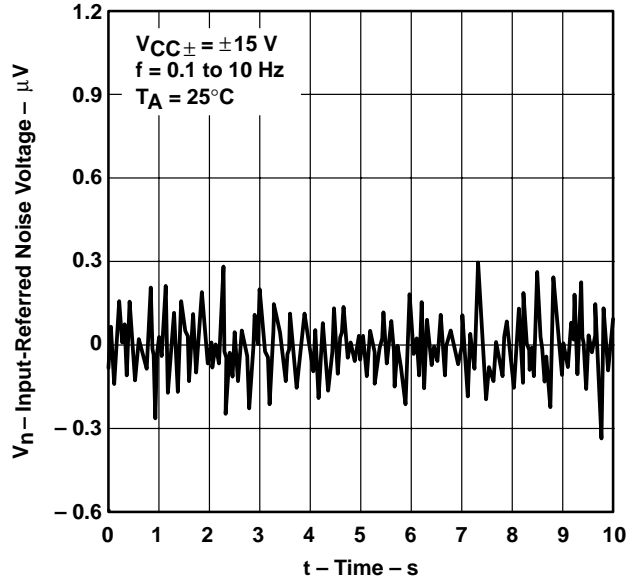

Figure 59

THIRD-OCTAVE SPECTRAL NOISE DENSITY
vs
FREQUENCY BANDS

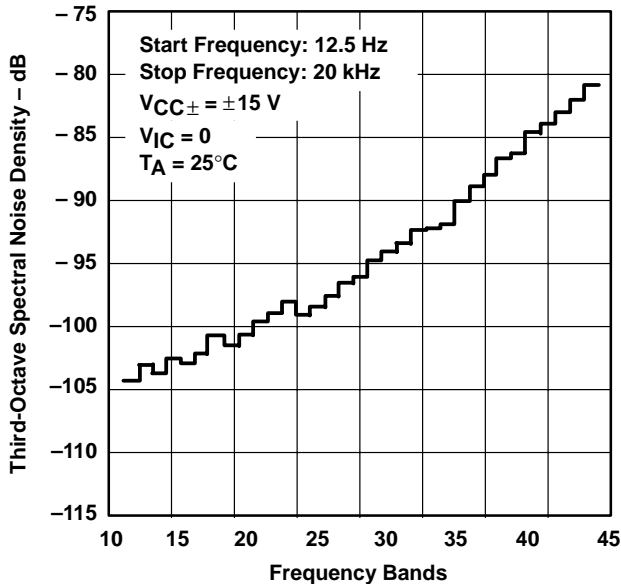

Figure 60

TOTAL HARMONIC DISTORTION PLUS NOISE
vs
FREQUENCY

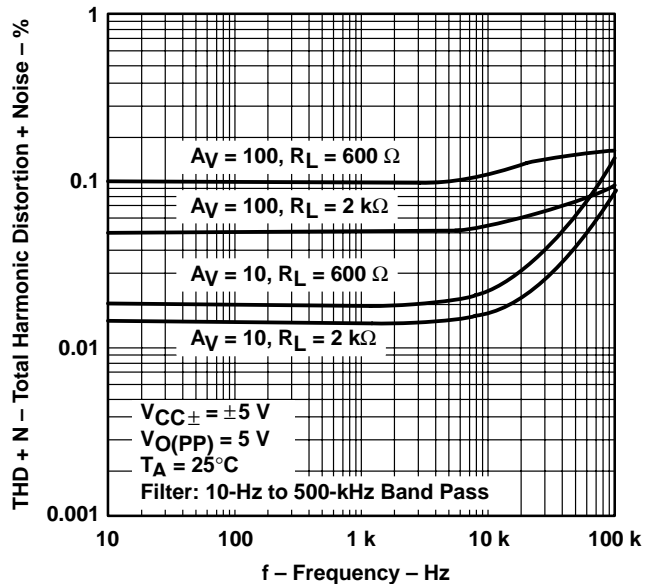

Figure 61



TYPICAL CHARACTERISTICS†

TOTAL HARMONIC DISTORTION PLUS NOISE
vs
FREQUENCY

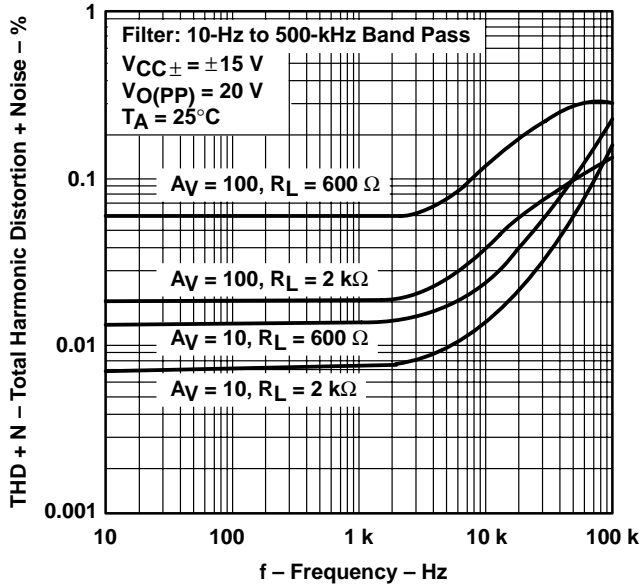

Figure 62

UNITY-GAIN BANDWIDTH
vs
LOAD CAPACITANCE

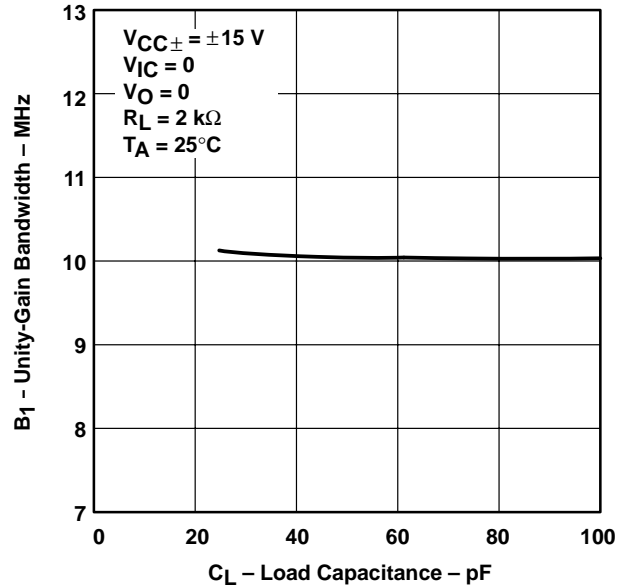

Figure 63

GAIN-BANDWIDTH PRODUCT
vs
FREE-AIR TEMPERATURE

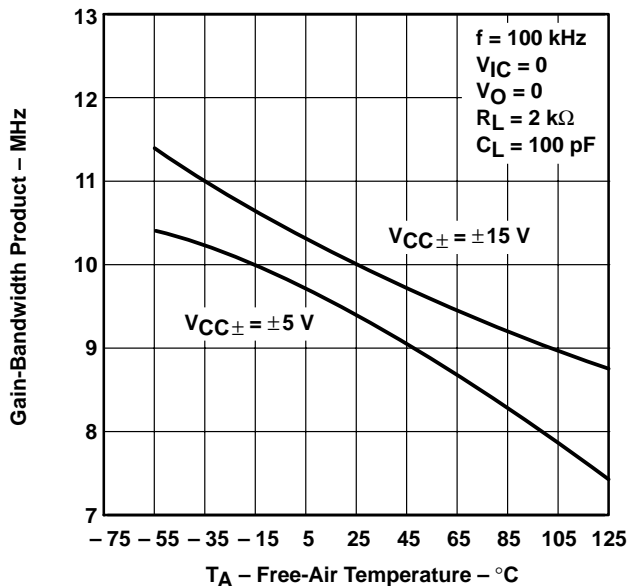

Figure 64

GAIN-BANDWIDTH PRODUCT
vs
SUPPLY VOLTAGE

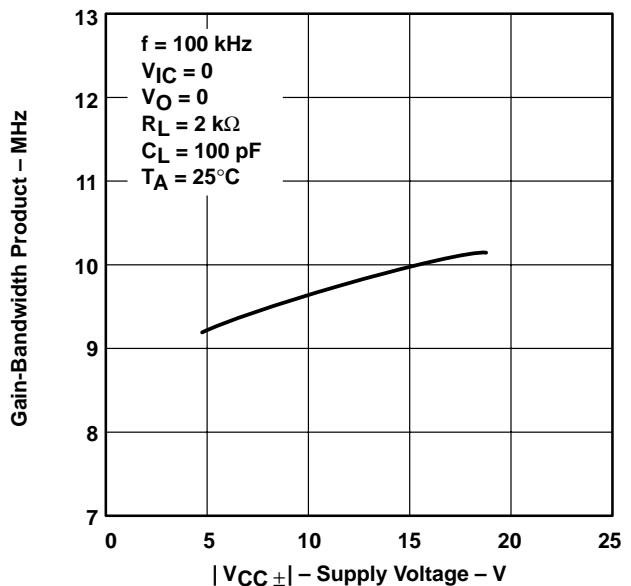

Figure 65

† Data at high and low temperatures are applicable only within the rated operating free-air temperature ranges of the various devices.

TLE208x, TLE208xA, TLE208xY EXCALIBUR HIGH-SPEED JFET-INPUT OPERATIONAL AMPLIFIERS

SLOS182B – FEBRUARY 1997 – REVISED JUNE 2001

TYPICAL CHARACTERISTICS†

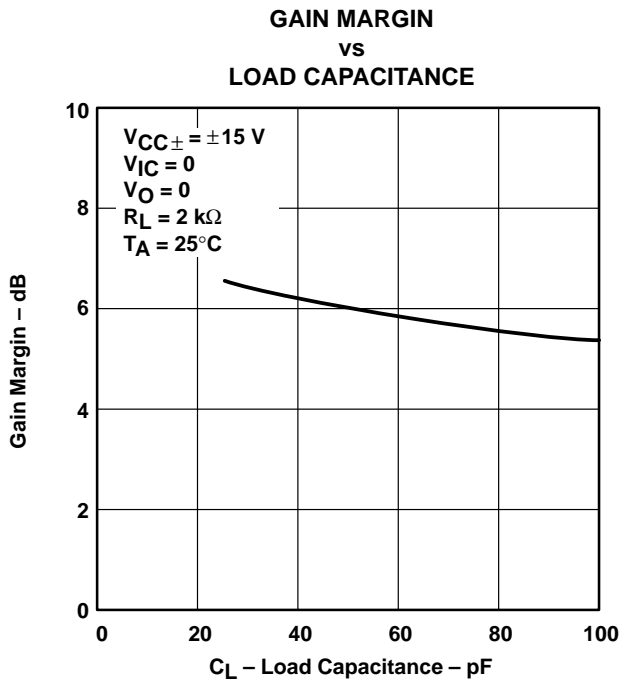

Figure 66

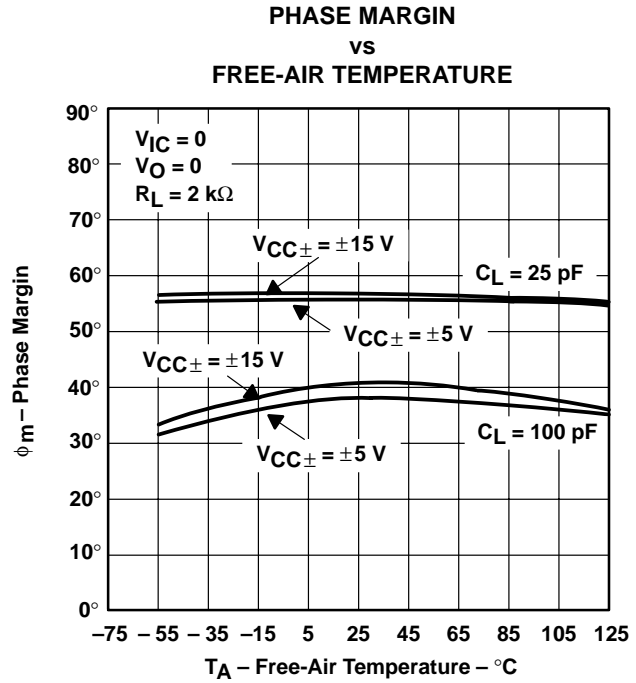

Figure 67

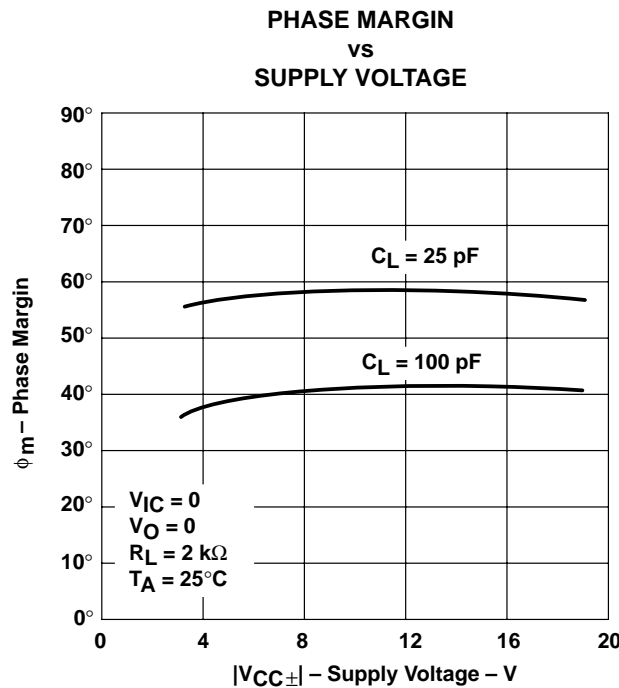

Figure 68

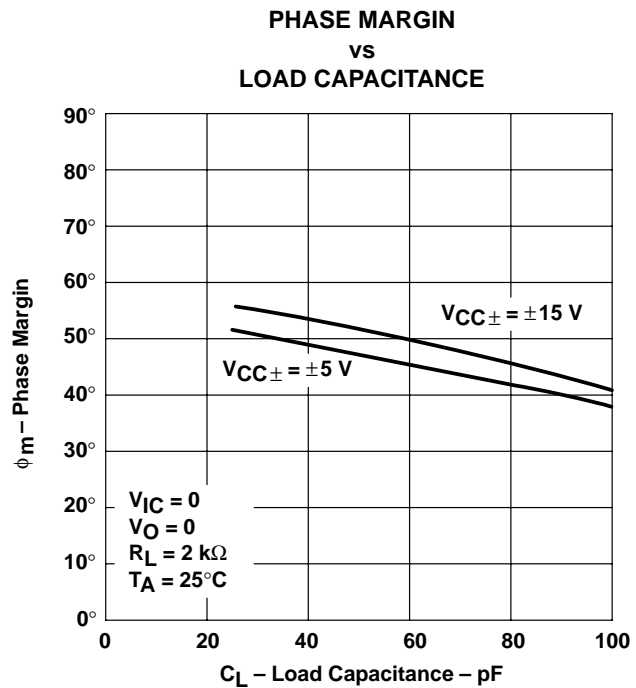

Figure 69

† Data at high and low temperatures are applicable only within the rated operating free-air temperature ranges of the various devices.

TYPICAL CHARACTERISTICS†

NONINVERTING LARGE-SIGNAL
PULSE RESPONSE

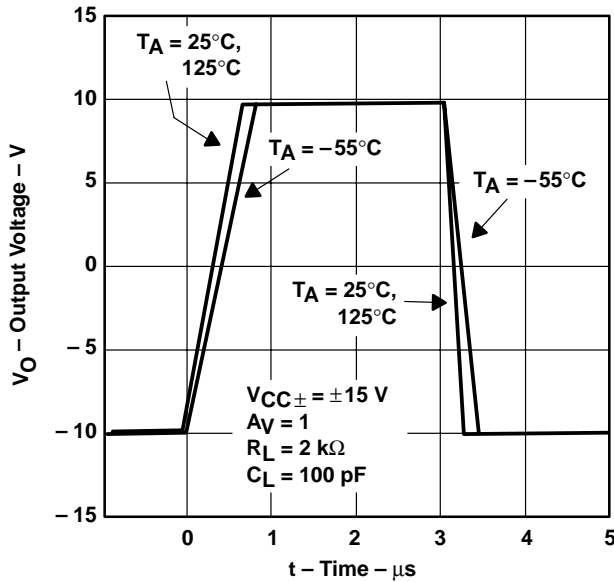

Figure 70

SMALL-SIGNAL PULSE RESPONSE



Figure 71

CLOSED-LOOP OUTPUT IMPEDANCE
vs
FREQUENCY

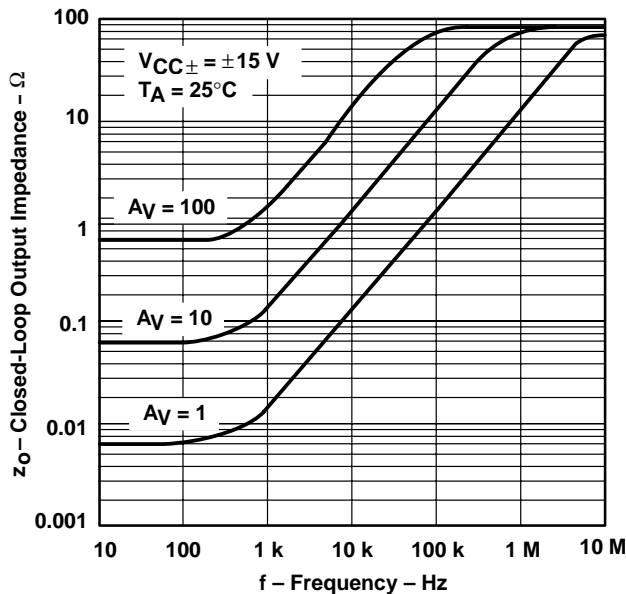

Figure 72

TLE2082 AND TLE2084
CROSSTALK ATTENUATION
vs
FREQUENCY



Figure 73

† Data at high and low temperatures are applicable only within the rated operating free-air temperature ranges of the various devices.

TLE208x, TLE208xA, TLE208xY EXCALIBUR HIGH-SPEED JFET-INPUT OPERATIONAL AMPLIFIERS

SLOS182B – FEBRUARY 1997 – REVISED JUNE 2001

APPLICATION INFORMATION

input characteristics

The TLE208x, TLE208xA, and TLE208xB are specified with a minimum and a maximum input voltage that if exceeded at either input could cause the device to malfunction. Because of the extremely high input impedance and resulting low bias current requirements, the TLE208x, TLE208xA, and TLE208xB are well suited for low-level signal processing; however, leakage currents on printed-circuit boards and sockets can easily exceed bias current requirements and cause degradation in system performance. It is good practice to include guard rings around inputs (see Figure 74). These guards should be driven from a low-impedance source at the same voltage level as the common-mode input.

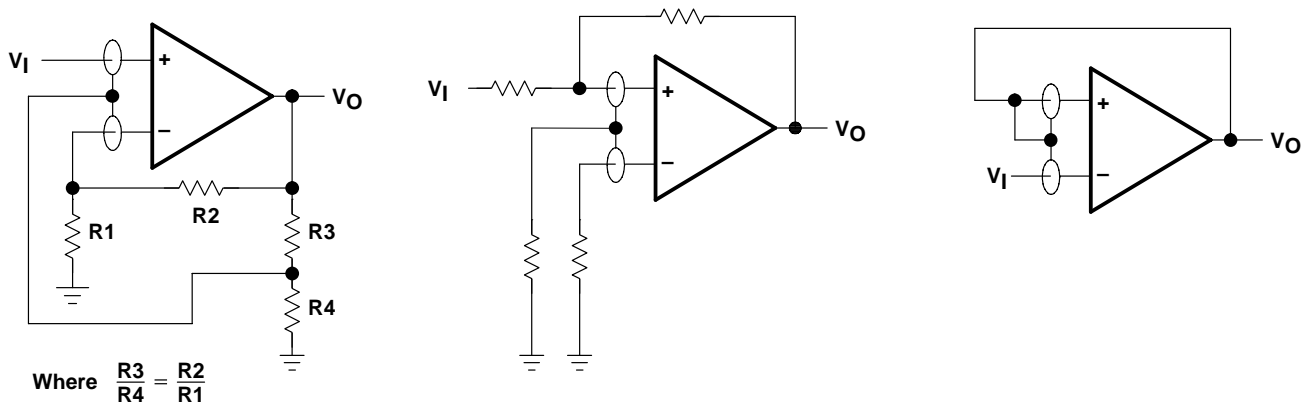

Figure 74. Use of Guard Rings

TLE2081 input offset voltage nulling

The TLE2061 series offers external null pins that can be used to further reduce the input offset voltage. The circuit of Figure 75 can be connected as shown if the feature is desired. When external nulling is not needed, the null pins may be left unconnected.

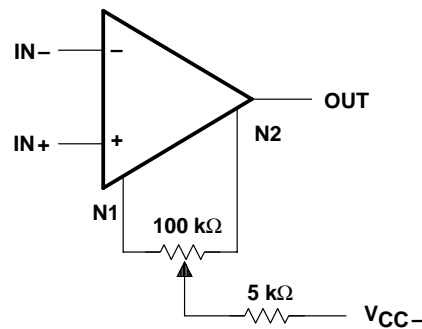

Figure 75. Input Offset Voltage Nulling

APPLICATION INFORMATION

macromodel information

Macromodel information provided was derived using *PSpice™ Parts™* model generation software. The Boyle macromodel (see Note 4) and subcircuit in Figure 58 were generated using the TLE208x typical electrical and operating characteristics at $T_A = 25^\circ\text{C}$. Using this information, output simulations of the following key parameters can be generated to a tolerance of 20% (in most cases):

- Maximum positive output voltage swing
- Maximum negative output voltage swing
- Slew rate
- Quiescent power dissipation
- Input bias current
- Open-loop voltage amplification
- Unity-gain frequency
- Common-mode rejection ratio
- Phase margin
- DC output resistance
- AC output resistance
- Short-circuit output current limit

NOTE 4: G.R. Boyle, B.M. Cohn, D. O. Pederson, and J. E. Solomon, "Macromodeling of Integrated Circuit Operational Amplifiers", *IEEE Journal of Solid-State Circuits*, SC-9, 353 (1974).

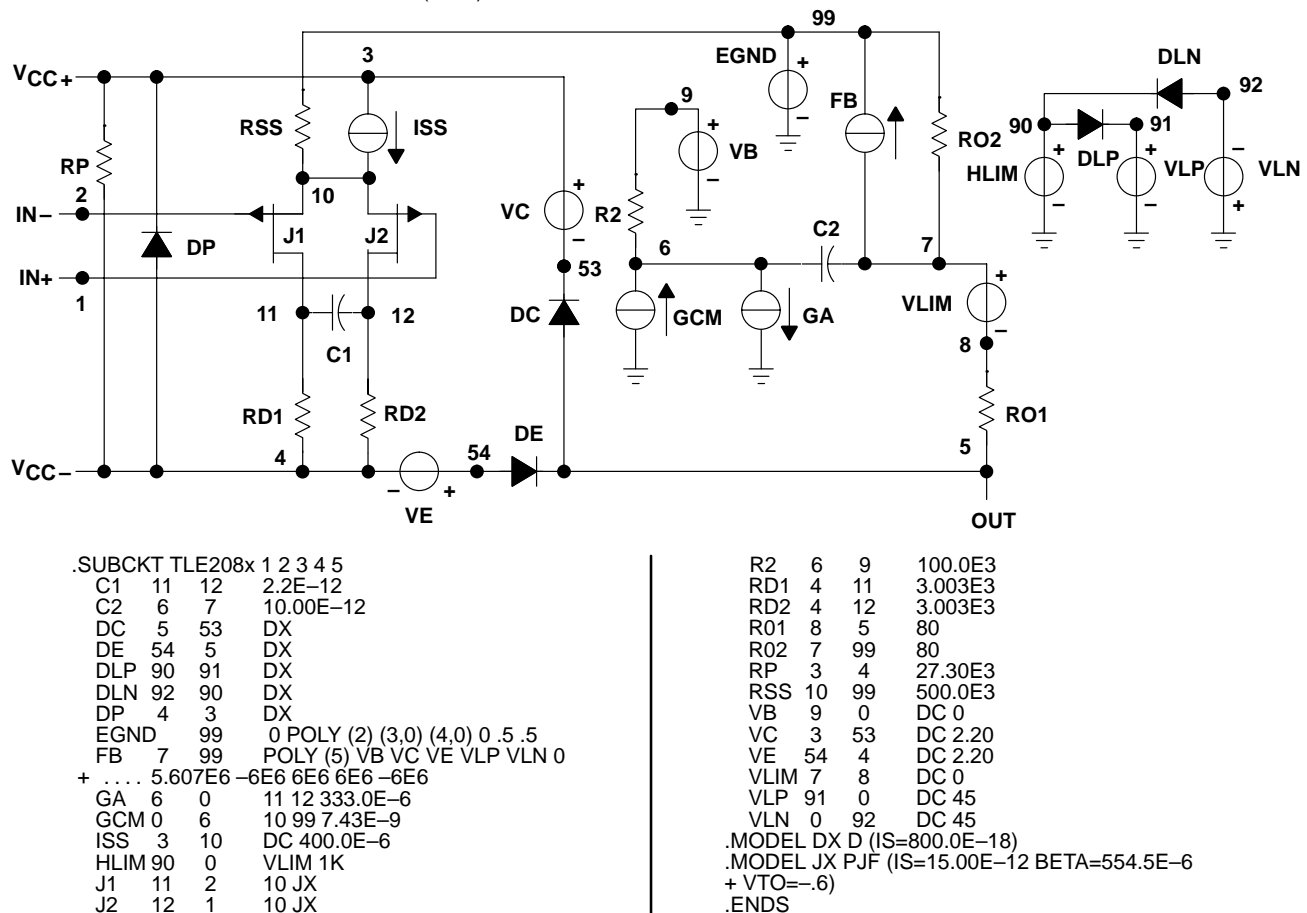

Figure 76. Boyle Macromodel and Subcircuit

PSpice and *Parts* are trademarks of MicroSim Corporation.

PACKAGING INFORMATION

| Orderable Device | Status ⁽¹⁾ | Package Type | Package Drawing | Pins | Package Qty | Eco Plan ⁽²⁾ | Lead/ Ball Finish | MSL Peak Temp ⁽³⁾ | Samples (Requires Login) |
|------------------|-----------------------|--------------|-----------------|------|-------------|----------------------------|----------------------|------------------------------|-----------------------------|
| TLE2081ACD | ACTIVE | SOIC | D | 8 | 75 | Green (RoHS & no Sb/Br) | CU NIPDAU | Level-1-260C-UNLIM | |
| TLE2081ACDG4 | ACTIVE | SOIC | D | 8 | 75 | Green (RoHS & no Sb/Br) | CU NIPDAU | Level-1-260C-UNLIM | |
| TLE2081ACDR | ACTIVE | SOIC | D | 8 | 2500 | Green (RoHS & no Sb/Br) | CU NIPDAU | Level-1-260C-UNLIM | |
| TLE2081ACDRG4 | ACTIVE | SOIC | D | 8 | 2500 | Green (RoHS & no Sb/Br) | CU NIPDAU | Level-1-260C-UNLIM | |
| TLE2081ACP | ACTIVE | PDIP | P | 8 | 50 | Pb-Free (RoHS) | CU NIPDAU | N / A for Pkg Type | |
| TLE2081ACPE4 | ACTIVE | PDIP | P | 8 | 50 | Pb-Free (RoHS) | CU NIPDAU | N / A for Pkg Type | |
| TLE2081AID | ACTIVE | SOIC | D | 8 | 75 | Green (RoHS & no Sb/Br) | CU NIPDAU | Level-1-260C-UNLIM | |
| TLE2081AIDG4 | ACTIVE | SOIC | D | 8 | 75 | Green (RoHS & no Sb/Br) | CU NIPDAU | Level-1-260C-UNLIM | |
| TLE2081AIP | ACTIVE | PDIP | P | 8 | 50 | Pb-Free (RoHS) | CU NIPDAU | N / A for Pkg Type | |
| TLE2081AIPe4 | ACTIVE | PDIP | P | 8 | 50 | Pb-Free (RoHS) | CU NIPDAU | N / A for Pkg Type | |
| TLE2081CD | ACTIVE | SOIC | D | 8 | 75 | Green (RoHS & no Sb/Br) | CU NIPDAU | Level-1-260C-UNLIM | |
| TLE2081CDG4 | ACTIVE | SOIC | D | 8 | 75 | Green (RoHS & no Sb/Br) | CU NIPDAU | Level-1-260C-UNLIM | |
| TLE2081CDR | ACTIVE | SOIC | D | 8 | 2500 | Green (RoHS & no Sb/Br) | CU NIPDAU | Level-1-260C-UNLIM | |
| TLE2081CDRG4 | ACTIVE | SOIC | D | 8 | 2500 | Green (RoHS & no Sb/Br) | CU NIPDAU | Level-1-260C-UNLIM | |
| TLE2081CP | ACTIVE | PDIP | P | 8 | 50 | Pb-Free (RoHS) | CU NIPDAU | N / A for Pkg Type | |
| TLE2081CPE4 | ACTIVE | PDIP | P | 8 | 50 | Pb-Free (RoHS) | CU NIPDAU | N / A for Pkg Type | |
| TLE2081ID | ACTIVE | SOIC | D | 8 | 75 | Green (RoHS & no Sb/Br) | CU NIPDAU | Level-1-260C-UNLIM | |
| TLE2081IDG4 | ACTIVE | SOIC | D | 8 | 75 | Green (RoHS & no Sb/Br) | CU NIPDAU | Level-1-260C-UNLIM | |
| TLE2081IDR | ACTIVE | SOIC | D | 8 | 2500 | Green (RoHS & no Sb/Br) | CU NIPDAU | Level-1-260C-UNLIM | |

| Orderable Device | Status ⁽¹⁾ | Package Type | Package Drawing | Pins | Package Qty | Eco Plan ⁽²⁾ | Lead/ Ball Finish | MSL Peak Temp ⁽³⁾ | Samples (Requires Login) |
|------------------|-----------------------|--------------|-----------------|------|-------------|-------------------------|----------------------|------------------------------|-----------------------------|
| TLE2081IDRG4 | ACTIVE | SOIC | D | 8 | 2500 | Green (RoHS & no Sb/Br) | CU NIPDAU | Level-1-260C-UNLIM | |
| TLE2081IP | ACTIVE | PDIP | P | 8 | 50 | Pb-Free (RoHS) | CU NIPDAU | N / A for Pkg Type | |
| TLE2081IPE4 | ACTIVE | PDIP | P | 8 | 50 | Pb-Free (RoHS) | CU NIPDAU | N / A for Pkg Type | |
| TLE2082ACD | ACTIVE | SOIC | D | 8 | 75 | Green (RoHS & no Sb/Br) | CU NIPDAU | Level-1-260C-UNLIM | |
| TLE2082ACDG4 | ACTIVE | SOIC | D | 8 | 75 | Green (RoHS & no Sb/Br) | CU NIPDAU | Level-1-260C-UNLIM | |
| TLE2082ACDR | ACTIVE | SOIC | D | 8 | 2500 | Green (RoHS & no Sb/Br) | CU NIPDAU | Level-1-260C-UNLIM | |
| TLE2082ACDRG4 | ACTIVE | SOIC | D | 8 | 2500 | Green (RoHS & no Sb/Br) | CU NIPDAU | Level-1-260C-UNLIM | |
| TLE2082ACP | ACTIVE | PDIP | P | 8 | 50 | Pb-Free (RoHS) | CU NIPDAU | N / A for Pkg Type | |
| TLE2082ACPE4 | ACTIVE | PDIP | P | 8 | 50 | Pb-Free (RoHS) | CU NIPDAU | N / A for Pkg Type | |
| TLE2082AID | ACTIVE | SOIC | D | 8 | 75 | Green (RoHS & no Sb/Br) | CU NIPDAU | Level-1-260C-UNLIM | |
| TLE2082AIDG4 | ACTIVE | SOIC | D | 8 | 75 | Green (RoHS & no Sb/Br) | CU NIPDAU | Level-1-260C-UNLIM | |
| TLE2082AIDR | ACTIVE | SOIC | D | 8 | 2500 | Green (RoHS & no Sb/Br) | CU NIPDAU | Level-1-260C-UNLIM | |
| TLE2082AIDRG4 | ACTIVE | SOIC | D | 8 | 2500 | Green (RoHS & no Sb/Br) | CU NIPDAU | Level-1-260C-UNLIM | |
| TLE2082AIP | ACTIVE | PDIP | P | 8 | 50 | Pb-Free (RoHS) | CU NIPDAU | N / A for Pkg Type | |
| TLE2082AIPE4 | ACTIVE | PDIP | P | 8 | 50 | Pb-Free (RoHS) | CU NIPDAU | N / A for Pkg Type | |
| TLE2082AMFKB | NRND | LCCC | FK | 20 | 1 | TBD | POST-PLATE | N / A for Pkg Type | |
| TLE2082AMJGB | ACTIVE | CDIP | JG | 8 | 1 | TBD | A42 | N / A for Pkg Type | |
| TLE2082AMP | OBSOLETE | PDIP | P | 8 | | TBD | Call TI | Call TI | |
| TLE2082CD | ACTIVE | SOIC | D | 8 | 75 | Green (RoHS & no Sb/Br) | CU NIPDAU | Level-1-260C-UNLIM | |
| TLE2082CDG4 | ACTIVE | SOIC | D | 8 | 75 | Green (RoHS & no Sb/Br) | CU NIPDAU | Level-1-260C-UNLIM | |
| TLE2082CDR | ACTIVE | SOIC | D | 8 | 2500 | Green (RoHS & no Sb/Br) | CU NIPDAU | Level-1-260C-UNLIM | |
| TLE2082CDRG4 | ACTIVE | SOIC | D | 8 | 2500 | Green (RoHS & no Sb/Br) | CU NIPDAU | Level-1-260C-UNLIM | |

| Orderable Device | Status ⁽¹⁾ | Package Type | Package Drawing | Pins | Package Qty | Eco Plan ⁽²⁾ | Lead/ Ball Finish | MSL Peak Temp ⁽³⁾ | Samples (Requires Login) |
|------------------|-----------------------|--------------|-----------------|------|-------------|----------------------------|----------------------|------------------------------|-----------------------------|
| TLE2082CP | ACTIVE | PDIP | P | 8 | 50 | Pb-Free (RoHS) | CU NIPDAU | N / A for Pkg Type | |
| TLE2082CPE4 | ACTIVE | PDIP | P | 8 | 50 | Pb-Free (RoHS) | CU NIPDAU | N / A for Pkg Type | |
| TLE2082ID | ACTIVE | SOIC | D | 8 | 75 | Green (RoHS & no Sb/Br) | CU NIPDAU | Level-1-260C-UNLIM | |
| TLE2082IDG4 | ACTIVE | SOIC | D | 8 | 75 | Green (RoHS & no Sb/Br) | CU NIPDAU | Level-1-260C-UNLIM | |
| TLE2082IDR | ACTIVE | SOIC | D | 8 | 2500 | Green (RoHS & no Sb/Br) | CU NIPDAU | Level-1-260C-UNLIM | |
| TLE2082IDRG4 | ACTIVE | SOIC | D | 8 | 2500 | Green (RoHS & no Sb/Br) | CU NIPDAU | Level-1-260C-UNLIM | |
| TLE2082IP | ACTIVE | PDIP | P | 8 | 50 | Pb-Free (RoHS) | CU NIPDAU | N / A for Pkg Type | |
| TLE2082IPE4 | ACTIVE | PDIP | P | 8 | 50 | Pb-Free (RoHS) | CU NIPDAU | N / A for Pkg Type | |
| TLE2082MFKB | ACTIVE | LCCC | FK | 20 | 1 | TBD | POST-PLATE | N / A for Pkg Type | |
| TLE2082MJGB | OBSOLETE | CDIP | JG | 8 | | TBD | Call TI | Call TI | |
| TLE2082MP | OBSOLETE | PDIP | P | 8 | | TBD | Call TI | Call TI | |
| TLE2084ACDW | ACTIVE | SOIC | DW | 16 | 40 | Green (RoHS & no Sb/Br) | CU NIPDAU | Level-1-260C-UNLIM | |
| TLE2084ACDWG4 | ACTIVE | SOIC | DW | 16 | 40 | Green (RoHS & no Sb/Br) | CU NIPDAU | Level-1-260C-UNLIM | |
| TLE2084ACN | ACTIVE | PDIP | N | 14 | 25 | Pb-Free (RoHS) | CU NIPDAU | N / A for Pkg Type | |
| TLE2084ACNE4 | ACTIVE | PDIP | N | 14 | 25 | Pb-Free (RoHS) | CU NIPDAU | N / A for Pkg Type | |
| TLE2084CDW | ACTIVE | SOIC | DW | 16 | 40 | Green (RoHS & no Sb/Br) | CU NIPDAU | Level-1-260C-UNLIM | |
| TLE2084CDWG4 | ACTIVE | SOIC | DW | 16 | 40 | Green (RoHS & no Sb/Br) | CU NIPDAU | Level-1-260C-UNLIM | |
| TLE2084CDWR | ACTIVE | SOIC | DW | 16 | 2000 | Green (RoHS & no Sb/Br) | CU NIPDAU | Level-1-260C-UNLIM | |
| TLE2084CDWRG4 | ACTIVE | SOIC | DW | 16 | 2000 | Green (RoHS & no Sb/Br) | CU NIPDAU | Level-1-260C-UNLIM | |
| TLE2084CN | ACTIVE | PDIP | N | 14 | 25 | Pb-Free (RoHS) | CU NIPDAU | N / A for Pkg Type | |
| TLE2084CNE4 | ACTIVE | PDIP | N | 14 | 25 | Pb-Free (RoHS) | CU NIPDAU | N / A for Pkg Type | |
| TLE2084IDW | ACTIVE | SOIC | DW | 16 | 40 | Green (RoHS & no Sb/Br) | CU NIPDAU | Level-1-260C-UNLIM | |

| Orderable Device | Status ⁽¹⁾ | Package Type | Package Drawing | Pins | Package Qty | Eco Plan ⁽²⁾ | Lead/ Ball Finish | MSL Peak Temp ⁽³⁾ | Samples (Requires Login) |
|------------------|-----------------------|--------------|-----------------|------|-------------|----------------------------|----------------------|------------------------------|-----------------------------|
| TLE2084IDWG4 | ACTIVE | SOIC | DW | 16 | 40 | Green (RoHS & no Sb/Br) | CU NIPDAU | Level-1-260C-UNLIM | |
| TLE2084IDWR | OBSOLETE | SOIC | DW | 16 | | TBD | Call TI | Call TI | |

⁽¹⁾ The marketing status values are defined as follows:

ACTIVE: Product device recommended for new designs.

LIFEBUY: TI has announced that the device will be discontinued, and a lifetime-buy period is in effect.

NRND: Not recommended for new designs. Device is in production to support existing customers, but TI does not recommend using this part in a new design.

PREVIEW: Device has been announced but is not in production. Samples may or may not be available.

OBSOLETE: TI has discontinued the production of the device.

⁽²⁾ Eco Plan - The planned eco-friendly classification: Pb-Free (RoHS), Pb-Free (RoHS Exempt), or Green (RoHS & no Sb/Br) - please check <http://www.ti.com/productcontent> for the latest availability information and additional product content details.

TBD: The Pb-Free/Green conversion plan has not been defined.

Pb-Free (RoHS): TI's terms "Lead-Free" or "Pb-Free" mean semiconductor products that are compatible with the current RoHS requirements for all 6 substances, including the requirement that lead not exceed 0.1% by weight in homogeneous materials. Where designed to be soldered at high temperatures, TI Pb-Free products are suitable for use in specified lead-free processes.

Pb-Free (RoHS Exempt): This component has a RoHS exemption for either 1) lead-based flip-chip solder bumps used between the die and package, or 2) lead-based die adhesive used between the die and leadframe. The component is otherwise considered Pb-Free (RoHS compatible) as defined above.

Green (RoHS & no Sb/Br): TI defines "Green" to mean Pb-Free (RoHS compatible), and free of Bromine (Br) and Antimony (Sb) based flame retardants (Br or Sb do not exceed 0.1% by weight in homogeneous material)

⁽³⁾ MSL, Peak Temp. -- The Moisture Sensitivity Level rating according to the JEDEC industry standard classifications, and peak solder temperature.

Important Information and Disclaimer: The information provided on this page represents TI's knowledge and belief as of the date that it is provided. TI bases its knowledge and belief on information provided by third parties, and makes no representation or warranty as to the accuracy of such information. Efforts are underway to better integrate information from third parties. TI has taken and continues to take reasonable steps to provide representative and accurate information but may not have conducted destructive testing or chemical analysis on incoming materials and chemicals. TI and TI suppliers consider certain information to be proprietary, and thus CAS numbers and other limited information may not be available for release.

In no event shall TI's liability arising out of such information exceed the total purchase price of the TI part(s) at issue in this document sold by TI to Customer on an annual basis.

OTHER QUALIFIED VERSIONS OF TLE2082, TLE2082A, TLE2082AM, TLE2082M :

● Catalog: [TLE2082A](#), [TLE2082](#)

● Military: [TLE2082M](#), [TLE2082AM](#)

NOTE: Qualified Version Definitions:

- Catalog - TI's standard catalog product
- Military - QML certified for Military and Defense Applications

TAPE AND REEL INFORMATION



QUADRANT ASSIGNMENTS FOR PIN 1 ORIENTATION IN TAPE



*All dimensions are nominal

| Device | Package Type | Package Drawing | Pins | SPQ | Reel Diameter (mm) | Reel Width W1 (mm) | A0 (mm) | B0 (mm) | K0 (mm) | P1 (mm) | W (mm) | Pin1 Quadrant |
|-------------|--------------|-----------------|------|------|--------------------|--------------------|---------|---------|---------|---------|--------|---------------|
| TLE2081ACDR | SOIC | D | 8 | 2500 | 330.0 | 12.4 | 6.4 | 5.2 | 2.1 | 8.0 | 12.0 | Q1 |
| TLE2081CDR | SOIC | D | 8 | 2500 | 330.0 | 12.4 | 6.4 | 5.2 | 2.1 | 8.0 | 12.0 | Q1 |
| TLE2081IDR | SOIC | D | 8 | 2500 | 330.0 | 12.4 | 6.4 | 5.2 | 2.1 | 8.0 | 12.0 | Q1 |
| TLE2081IDR | SOIC | D | 8 | 2500 | 330.0 | 12.4 | 6.4 | 5.2 | 2.1 | 8.0 | 12.0 | Q1 |
| TLE2082ACDR | SOIC | D | 8 | 2500 | 330.0 | 12.4 | 6.4 | 5.2 | 2.1 | 8.0 | 12.0 | Q1 |
| TLE2082AIDR | SOIC | D | 8 | 2500 | 330.0 | 12.4 | 6.4 | 5.2 | 2.1 | 8.0 | 12.0 | Q1 |
| TLE2082AIDR | SOIC | D | 8 | 2500 | 330.0 | 12.4 | 6.4 | 5.2 | 2.1 | 8.0 | 12.0 | Q1 |
| TLE2082CDR | SOIC | D | 8 | 2500 | 330.0 | 12.4 | 6.4 | 5.2 | 2.1 | 8.0 | 12.0 | Q1 |
| TLE2082IDR | SOIC | D | 8 | 2500 | 330.0 | 12.4 | 6.4 | 5.2 | 2.1 | 8.0 | 12.0 | Q1 |
| TLE2084CDWR | SOIC | DW | 16 | 2000 | 330.0 | 16.4 | 10.75 | 10.7 | 2.7 | 12.0 | 16.0 | Q1 |

TAPE AND REEL BOX DIMENSIONS

*All dimensions are nominal

| Device | Package Type | Package Drawing | Pins | SPQ | Length (mm) | Width (mm) | Height (mm) |
|-------------|--------------|-----------------|------|------|-------------|------------|-------------|
| TLE2081ACDR | SOIC | D | 8 | 2500 | 340.5 | 338.1 | 20.6 |
| TLE2081CDR | SOIC | D | 8 | 2500 | 340.5 | 338.1 | 20.6 |
| TLE2081IDR | SOIC | D | 8 | 2500 | 340.5 | 338.1 | 20.6 |
| TLE2081IDR | SOIC | D | 8 | 2500 | 346.0 | 346.0 | 29.0 |
| TLE2082ACDR | SOIC | D | 8 | 2500 | 340.5 | 338.1 | 20.6 |
| TLE2082AIDR | SOIC | D | 8 | 2500 | 346.0 | 346.0 | 29.0 |
| TLE2082AIDR | SOIC | D | 8 | 2500 | 340.5 | 338.1 | 20.6 |
| TLE2082CDR | SOIC | D | 8 | 2500 | 340.5 | 338.1 | 20.6 |
| TLE2082IDR | SOIC | D | 8 | 2500 | 340.5 | 338.1 | 20.6 |
| TLE2084CDWR | SOIC | DW | 16 | 2000 | 346.0 | 346.0 | 33.0 |

JG (R-GDIP-T8)

CERAMIC DUAL-IN-LINE



- NOTES: A. All linear dimensions are in inches (millimeters).
 B. This drawing is subject to change without notice.
 C. This package can be hermetically sealed with a ceramic lid using glass frit.
 D. Index point is provided on cap for terminal identification.
 E. Falls within MIL STD 1835 GDIP1-T8

FK (S-CQCC-N**)

LEADLESS CERAMIC CHIP CARRIER

28 TERMINAL SHOWN



| NO. OF TERMINALS ** | A | | B | |
|---------------------|------------------|------------------|------------------|------------------|
| | MIN | MAX | MIN | MAX |
| 20 | 0.342 (8,69) | 0.358 (9,09) | 0.307 (7,80) | 0.358 (9,09) |
| 28 | 0.442 (11,23) | 0.458 (11,63) | 0.406 (10,31) | 0.458 (11,63) |
| 44 | 0.640 (16,26) | 0.660 (16,76) | 0.495 (12,58) | 0.560 (14,22) |
| 52 | 0.740 (18,78) | 0.761 (19,32) | 0.495 (12,58) | 0.560 (14,22) |
| 68 | 0.938 (23,83) | 0.962 (24,43) | 0.850 (21,6) | 0.858 (21,8) |
| 84 | 1.141 (28,99) | 1.165 (29,59) | 1.047 (26,6) | 1.063 (27,0) |



4040140/D 01/11

- NOTES:
- All linear dimensions are in inches (millimeters).
 - This drawing is subject to change without notice.
 - This package can be hermetically sealed with a metal lid.
 - Falls within JEDEC MS-004

P (R-PDIP-T8)

PLASTIC DUAL-IN-LINE PACKAGE



- NOTES:
- A. All linear dimensions are in inches (millimeters).
 - B. This drawing is subject to change without notice.
 - C. Falls within JEDEC MS-001 variation BA.

D (R-PDSO-G8)

PLASTIC SMALL OUTLINE



- NOTES:
- A. All linear dimensions are in inches (millimeters).
 - B. This drawing is subject to change without notice.
 - $\triangle C$ Body length does not include mold flash, protrusions, or gate burrs. Mold flash, protrusions, or gate burrs shall not exceed 0.006 (0,15) each side.
 - $\triangle D$ Body width does not include interlead flash. Interlead flash shall not exceed 0.017 (0,43) each side.
 - E. Reference JEDEC MS-012 variation AA.

D (R-PDSO-G8)

PLASTIC SMALL OUTLINE



4211283-2/D 06/11

- NOTES:
- All linear dimensions are in millimeters.
 - This drawing is subject to change without notice.
 - Publication IPC-7351 is recommended for alternate designs.
 - Laser cutting apertures with trapezoidal walls and also rounding corners will offer better paste release. Customers should contact their board assembly site for stencil design recommendations. Refer to IPC-7525 for other stencil recommendations.
 - Customers should contact their board fabrication site for solder mask tolerances between and around signal pads.

DW (R-PDSO-G16)

PLASTIC SMALL OUTLINE



- NOTES:
- A. All linear dimensions are in inches (millimeters). Dimensioning and tolerancing per ASME Y14.5M-1994.
 - B. This drawing is subject to change without notice.
 - C. Body dimensions do not include mold flash or protrusion not to exceed 0.006 (0,15).
 - D. Falls within JEDEC MS-013 variation AA.

IMPORTANT NOTICE

Texas Instruments Incorporated and its subsidiaries (TI) reserve the right to make corrections, modifications, enhancements, improvements, and other changes to its products and services at any time and to discontinue any product or service without notice. Customers should obtain the latest relevant information before placing orders and should verify that such information is current and complete. All products are sold subject to TI's terms and conditions of sale supplied at the time of order acknowledgment.

TI warrants performance of its hardware products to the specifications applicable at the time of sale in accordance with TI's standard warranty. Testing and other quality control techniques are used to the extent TI deems necessary to support this warranty. Except where mandated by government requirements, testing of all parameters of each product is not necessarily performed.

TI assumes no liability for applications assistance or customer product design. Customers are responsible for their products and applications using TI components. To minimize the risks associated with customer products and applications, customers should provide adequate design and operating safeguards.

TI does not warrant or represent that any license, either express or implied, is granted under any TI patent right, copyright, mask work right, or other TI intellectual property right relating to any combination, machine, or process in which TI products or services are used. Information published by TI regarding third-party products or services does not constitute a license from TI to use such products or services or a warranty or endorsement thereof. Use of such information may require a license from a third party under the patents or other intellectual property of the third party, or a license from TI under the patents or other intellectual property of TI.

Reproduction of TI information in TI data books or data sheets is permissible only if reproduction is without alteration and is accompanied by all associated warranties, conditions, limitations, and notices. Reproduction of this information with alteration is an unfair and deceptive business practice. TI is not responsible or liable for such altered documentation. Information of third parties may be subject to additional restrictions.

Resale of TI products or services with statements different from or beyond the parameters stated by TI for that product or service voids all express and any implied warranties for the associated TI product or service and is an unfair and deceptive business practice. TI is not responsible or liable for any such statements.

TI products are not authorized for use in safety-critical applications (such as life support) where a failure of the TI product would reasonably be expected to cause severe personal injury or death, unless officers of the parties have executed an agreement specifically governing such use. Buyers represent that they have all necessary expertise in the safety and regulatory ramifications of their applications, and acknowledge and agree that they are solely responsible for all legal, regulatory and safety-related requirements concerning their products and any use of TI products in such safety-critical applications, notwithstanding any applications-related information or support that may be provided by TI. Further, Buyers must fully indemnify TI and its representatives against any damages arising out of the use of TI products in such safety-critical applications.

TI products are neither designed nor intended for use in military/aerospace applications or environments unless the TI products are specifically designated by TI as military-grade or "enhanced plastic." Only products designated by TI as military-grade meet military specifications. Buyers acknowledge and agree that any such use of TI products which TI has not designated as military-grade is solely at the Buyer's risk, and that they are solely responsible for compliance with all legal and regulatory requirements in connection with such use.

TI products are neither designed nor intended for use in automotive applications or environments unless the specific TI products are designated by TI as compliant with ISO/TS 16949 requirements. Buyers acknowledge and agree that, if they use any non-designated products in automotive applications, TI will not be responsible for any failure to meet such requirements.

Following are URLs where you can obtain information on other Texas Instruments products and application solutions:

Products

| | |
|------------------------|--|
| Audio | www.ti.com/audio |
| Amplifiers | amplifier.ti.com |
| Data Converters | dataconverter.ti.com |
| DLP® Products | www.dlp.com |
| DSP | dsp.ti.com |
| Clocks and Timers | www.ti.com/clocks |
| Interface | interface.ti.com |
| Logic | logic.ti.com |
| Power Mgmt | power.ti.com |
| Microcontrollers | microcontroller.ti.com |
| RFID | www.ti-rfid.com |
| OMAP Mobile Processors | www.ti.com/omap |
| Wireless Connectivity | www.ti.com/wirelessconnectivity |

Applications

| | |
|-------------------------------|--|
| Automotive and Transportation | www.ti.com/automotive |
| Communications and Telecom | www.ti.com/communications |
| Computers and Peripherals | www.ti.com/computers |
| Consumer Electronics | www.ti.com/consumer-apps |
| Energy and Lighting | www.ti.com/energy |
| Industrial | www.ti.com/industrial |
| Medical | www.ti.com/medical |
| Security | www.ti.com/security |
| Space, Avionics and Defense | www.ti.com/space-avionics-defense |
| Video and Imaging | www.ti.com/video |

TI E2E Community Home Page

e2e.ti.com

Mailing Address: Texas Instruments, Post Office Box 655303, Dallas, Texas 75265
Copyright © 2012, Texas Instruments Incorporated