

TPA6101A2

50-mW ULTRALOW-VOLTAGE, FIXED-GAIN STEREO HEADPHONE AUDIO POWER AMPLIFIER

SLOS331B – AUGUST 2000 – REVISED SEPTEMBER 2004

- Minimal External Components Required
- 1.6-V to 3.6-V Supply Voltage Range
- 50-mW Stereo Output
- Low Supply Current . . . 0.75 mA
- Low Shutdown Current . . . 50 nA
- Gain Set Internally to 2 dB
- Pop Reduction Circuitry
- Internal Mid-Rail Generation
- Thermal and Short-Circuit Protection
- Surface-Mount Packaging
 - MSOP
 - SOIC

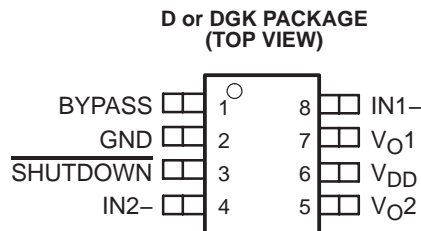

description

The TPA6101A2 is a stereo audio power amplifier packaged in either an 8-pin SOIC package or an 8-pin MOSP package capable of delivering 50 mW of continuous RMS power per channel into 16-Ω loads. Amplifier gain is internally set to 2 dB (inverting) to save board space by eliminating six external resistors.

The TPA6101A2 is optimized for battery applications because of its low-supply current, shutdown current, and THD+N. To obtain the low-supply voltage range, the TPA6101A2 biases BYPASS to $V_{DD}/4$.

When driving a 16-Ω load with 40-mW output power from 3.3 V, THD+N is 0.08% at 1 kHz, and less than 0.2% across the audio band of 20 Hz to 20 kHz. For 30 mW into 32-Ω loads, the THD+N is reduced to less than 0.06% at 1 kHz, and is less than 0.3% across the audio band of 20 Hz to 20 kHz.

typical application circuit

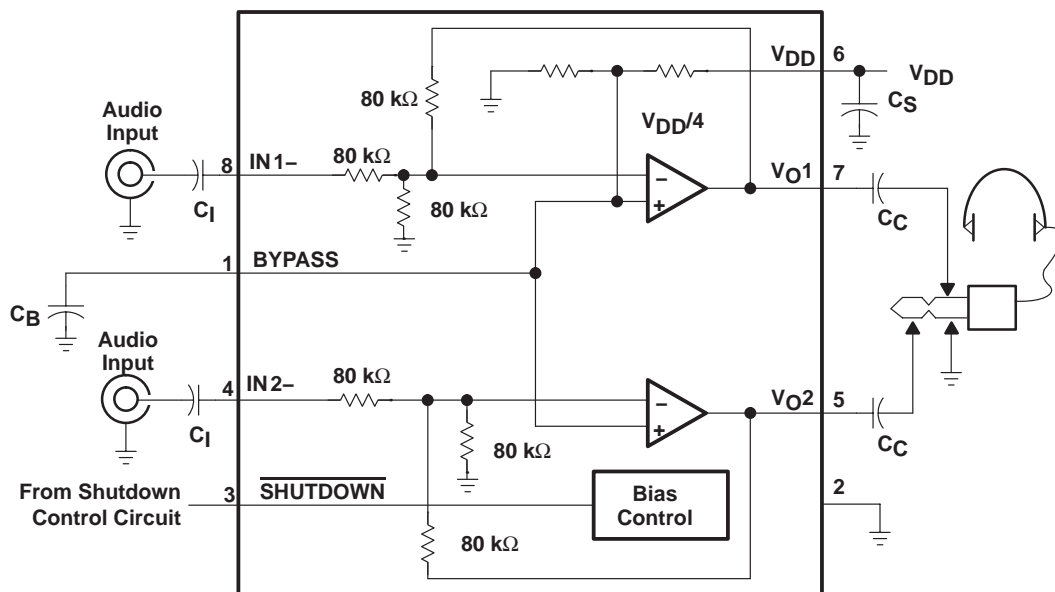

NOTE: All internal resistor values are $\pm 20\%$.



Please be aware that an important notice concerning availability, standard warranty, and use in critical applications of Texas Instruments semiconductor products and disclaimers thereto appears at the end of this data sheet.

PRODUCTION DATA information is current as of publication date. Products conform to specifications per the terms of Texas Instruments standard warranty. Production processing does not necessarily include testing of all parameters.

**TEXAS
INSTRUMENTS**

POST OFFICE BOX 655303 • DALLAS, TEXAS 75265

Copyright © 2004, Texas Instruments Incorporated

TPA6101A2
50-mW ULTRALOW-VOLTAGE, FIXED-GAIN STEREO HEADPHONE
AUDIO POWER AMPLIFIER

SLOS331B – AUGUST 2000 – REVISED SEPTEMBER 2004

AVAILABLE OPTIONS

T _A	PACKAGED DEVICE		MSOP SYMBOLIZATION
	SMALL OUTLINE (D)	MSOP (DGK)	
-40°C to 85°C	TPA6101A2D	TPA6101A2DGK	AJM

Terminal Functions

TERMINAL NAME	NO.	I/O	DESCRIPTION
BYPASS	1	I	Tap to voltage divider for internal mid-supply bias supply. BYPASS is set at V _{DD} /4. Connect to a 0.1-μF to 1-μF low-ESR capacitor for best performance.
GND	2	I	GND is the ground connection.
IN1-	8	I	IN1- is the inverting input for channel 1.
IN2-	4	I	IN2- is the inverting input for channel 2.
SHUTDOWN	3	I	Active-low input. When held low, the device is placed in a low-supply current mode.
V _{DD}	6	I	V _{DD} is the supply voltage terminal.
V _{O1}	7	O	V _{O1} is the audio output for channel 1.
V _{O2}	5	O	V _{O2} is the audio output for channel 2.

absolute maximum ratings over operating free-air temperature (unless otherwise noted)†

Supply voltage, V _{DD}	4 V
Input voltage, V _I	-0.3 V to V _{DD} + 0.3 V
Continuous total power dissipation	Internally Limited
Operating junction temperature range, T _J	-40°C to 150°C
Storage temperature range, T _{stg}	-65°C to 150°C
Lead temperature 1,6 mm (1/16 inch) from case for 10 seconds	260°C

† Stresses beyond those listed under “absolute maximum ratings” may cause permanent damage to the device. These are stress ratings only, and functional operation of the device at these or any other conditions beyond those indicated under “recommended operating conditions” is not implied. Exposure to absolute-maximum-rated conditions for extended periods may affect device reliability.

DISSIPATION RATING TABLE

PACKAGE	T _A ≤ 25°C POWER RATING	DERATING FACTOR ABOVE T _A = 25°C	T _A = 70°C POWER RATING	T _A = 85°C POWER RATING
D	710 mW	5.68 mW/°C	454 mW	369 mW
DGK	469 mW	3.75 mW/°C	300 mW	244 mW

recommended operating conditions

	MIN	MAX	UNIT
Supply voltage, V _{DD}	1.6	3.6	V
High-level input voltage, V _{IH} (SHUTDOWN)	60% x V _{DD}		V
Low-level input voltage, V _{IL} (SHUTDOWN)		25% x V _{DD}	V
Operating free-air temperature, T _A	-40	85	°C



TPA6101A2
50-mW ULTRALOW-VOLTAGE, FIXED-GAIN STEREO HEADPHONE
AUDIO POWER AMPLIFIER

SLOS331B – AUGUST 2000 – REVISED SEPTEMBER 2004

dc electrical characteristics at $T_A = 25^\circ\text{C}$, $V_{DD} = 3.6\text{ V}$ (unless otherwise noted)

PARAMETER		TEST CONDITIONS	MIN	TYP	MAX	UNIT
V_{OO}	Output offset voltage	$A_V = 2\text{ dB}$		5	40	mV
PSRR	Power supply rejection ratio	$V_{DD} = 3\text{ V to } 3.6\text{ V}$		72		dB
I_{DD}	Supply current	$\overline{\text{SHUTDOWN}} = 3.6\text{ V}$		0.75	1.5	mA
$I_{DD}(\text{SD})$	Supply current in $\overline{\text{SHUTDOWN}}$ mode	$\overline{\text{SHUTDOWN}} = 0\text{ V}$		50	250	nA
$ I_{IH} $	High-level input current ($\overline{\text{SHUTDOWN}}$)	$V_{DD} = 3.6\text{ V}$, $V_I = V_{DD}$			1	μA
$ I_{IL} $	Low-level input current ($\overline{\text{SHUTDOWN}}$)	$V_{DD} = 3.6\text{ V}$, $V_I = 0\text{ V}$			1	μA
Z_I	Input impedance			80		$\text{k}\Omega$

ac operating characteristics, $V_{DD} = 3.3\text{ V}$, $T_A = 25^\circ\text{C}$, $R_L = 16\ \Omega$

PARAMETER		TEST CONDITIONS	MIN	TYP	MAX	UNIT
G	Gain			2		dB
P_O	Output power (each channel)	$\text{THD} \leq 0.1\%$, $f = 1\text{ kHz}$		50		mW
THD+N	Total harmonic distortion + noise	$P_O = 45\text{ mW}$, $20\text{--}20\text{ kHz}$		0.4%		
B_{OM}	Maximum output power BW	$\text{THD} < 0.5\%$		> 20		kHz
k_{SVR}	Supply ripple rejection ratio	$f = 1\text{ kHz}$		47		dB
SNR	Signal-to-noise ratio	$P_O = 50\text{ mW}$		86		dB
V_n	Noise output voltage (no-noise weighting filter)			45		$\mu\text{V}(\text{rms})$

ac operating characteristics, $V_{DD} = 3.3\text{ V}$, $T_A = 25^\circ\text{C}$, $R_L = 32\ \Omega$

PARAMETER		TEST CONDITIONS	MIN	TYP	MAX	UNIT
G	Gain			2		dB
P_O	Output power (each channel)	$\text{THD} \leq 0.1\%$, $f = 1\text{ kHz}$		35		mW
THD+N	Total harmonic distortion + noise	$P_O = 30\text{ mW}$, $20\text{--}20\text{ kHz}$		0.4%		
B_{OM}	Maximum output power BW	$\text{THD} < 0.4\%$		> 20		kHz
k_{SVR}	Supply ripple rejection ratio	$f = 1\text{ kHz}$		47		dB
SNR	Signal-to-noise ratio	$P_O = 30\text{ mW}$		86		dB
V_n	Noise output voltage (no-noise weighting filter)			50		$\mu\text{V}(\text{rms})$

TPA6101A2

50-mW ULTRALOW-VOLTAGE, FIXED-GAIN STEREO HEADPHONE AUDIO POWER AMPLIFIER

SLOS331B – AUGUST 2000 – REVISED SEPTEMBER 2004

dc electrical characteristics at $T_A = 25^\circ\text{C}$, $V_{DD} = 1.6\text{ V}$ (unless otherwise noted)

PARAMETER		TEST CONDITIONS	MIN	TYP	MAX	UNIT
V_{OO}	Output offset voltage	$A_V = 2\text{ dB}$		5	40	mV
PSRR	Power supply rejection ratio	$V_{DD} = 1.4\text{ V to } 1.8\text{ V}$		80		dB
I_{DD}	Supply current	$\overline{\text{SHUTDOWN}} = 1.6\text{ V}$		0.65	1.2	mA
$I_{DD}(\text{SD})$	Supply current in SHUTDOWN mode	$\overline{\text{SHUTDOWN}} = 0\text{ V}$		50	250	nA
$ I_{IH} $	High-level input current (SHUTDOWN)	$V_{DD} = 1.6\text{ V}, V_I = V_{DD}$			1	μA
$ I_{IL} $	Low-level input current (SHUTDOWN)	$V_{DD} = 1.6\text{ V}, V_I = 0\text{ V}$			1	μA
Z_I	Input impedance			80		k Ω

ac operating characteristics, $V_{DD} = 1.6\text{ V}$, $T_A = 25^\circ\text{C}$, $R_L = 16\ \Omega$

PARAMETER		TEST CONDITIONS	MIN	TYP	MAX	UNIT
G	Gain			2		dB
P_O	Output power (each channel)	THD $\leq 0.5\%$, $f = 1\text{ kHz}$		10		mW
THD+N	Total harmonic distortion + noise	$P_O = 9.5\text{ mW}$, $20\text{--}20\text{ kHz}$		0.06%		
B_{OM}	Maximum output power BW	THD $< 1\%$		> 20		kHz
k_{SVR}	Supply ripple rejection ratio	$f = 1\text{ kHz}$		47		dB
SNR	Signal-to-noise ratio	$P_O = 10\text{ mW}$		82		dB
V_n	Noise output voltage (no-noise weighting filter)			32		$\mu\text{V}(\text{rms})$

ac operating characteristics, $V_{DD} = 1.6\text{ V}$, $T_A = 25^\circ\text{C}$, $R_L = 32\ \Omega$

PARAMETER		TEST CONDITIONS	MIN	TYP	MAX	UNIT
G	Gain			2		dB
P_O	Output power (each channel)	THD $\leq 0.5\%$, $f = 1\text{ kHz}$		7.5		mW
THD+N	Total harmonic distortion + noise	$P_O = 6.5\text{ mW}$, $20\text{--}20\text{ kHz}$		0.05%		
B_{OM}	Maximum output power BW	THD $< 1\%$		> 20		kHz
k_{SVR}	Supply ripple rejection ratio	$f = 1\text{ kHz}$		47		dB
SNR	Signal-to-noise ratio	$P_O = 7.5\text{ mW}$		84		dB
V_n	Noise output voltage (no-noise weighting filter)			32		$\mu\text{V}(\text{rms})$

TYPICAL CHARACTERISTICS

Table of Graphs

		FIGURE
THD+N	Total harmonic distortion plus noise	vs Frequency
		1, 3, 5, 7, 9, 11
		vs Output power
		2, 4, 6, 8, 10, 12
		vs Output voltage
		13, 14
P_O	Output power	vs Load resistance
		15, 16
k_{SVR}	Supply ripple rejection ratio	vs Frequency
		17, 18
V_n	Output noise voltage	vs Frequency
		19, 20
	Crosstalk	vs Frequency
		21, 22
	Closed-loop gain and phase	vs Frequency
		23, 24, 25, 26
I_{DD}	Supply current	vs Supply voltage
		27
P_D	Power dissipation	vs Output power
		28



TPA6101A2
50-mW ULTRALOW-VOLTAGE, FIXED-GAIN STEREO HEADPHONE
AUDIO POWER AMPLIFIER

SLOS331B – AUGUST 2000 – REVISED SEPTEMBER 2004

TYPICAL CHARACTERISTICS

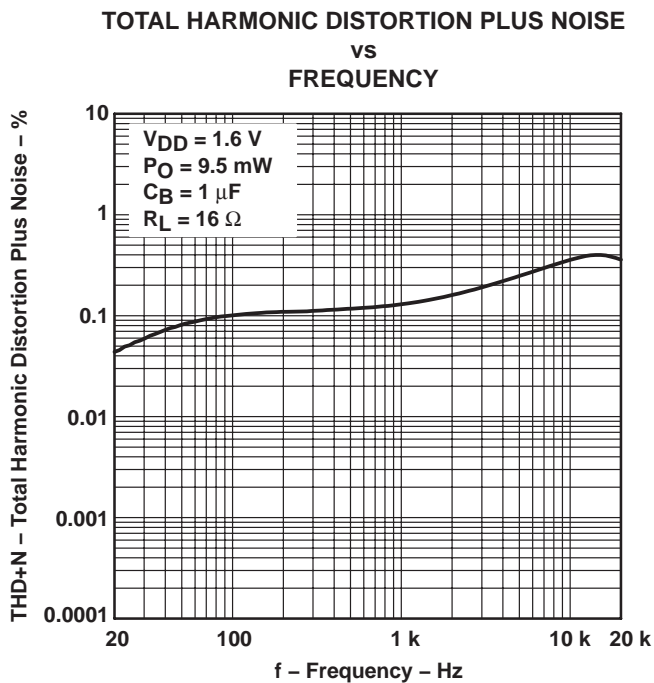

Figure 1

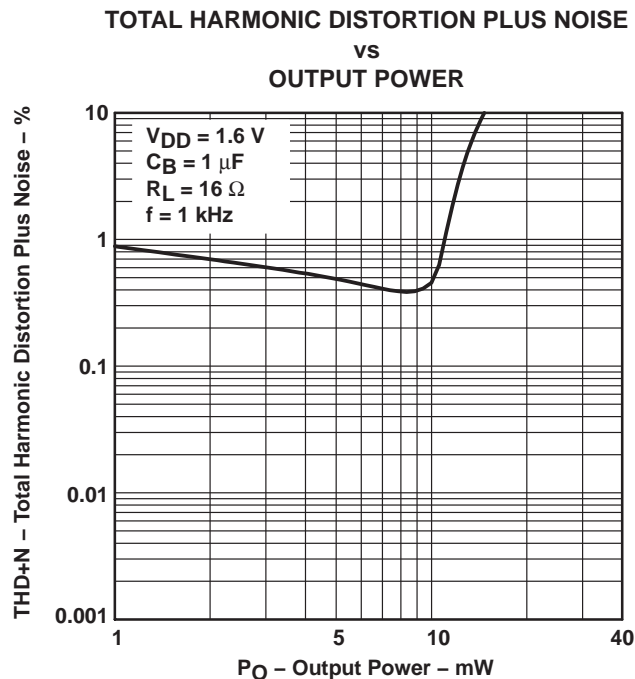

Figure 2

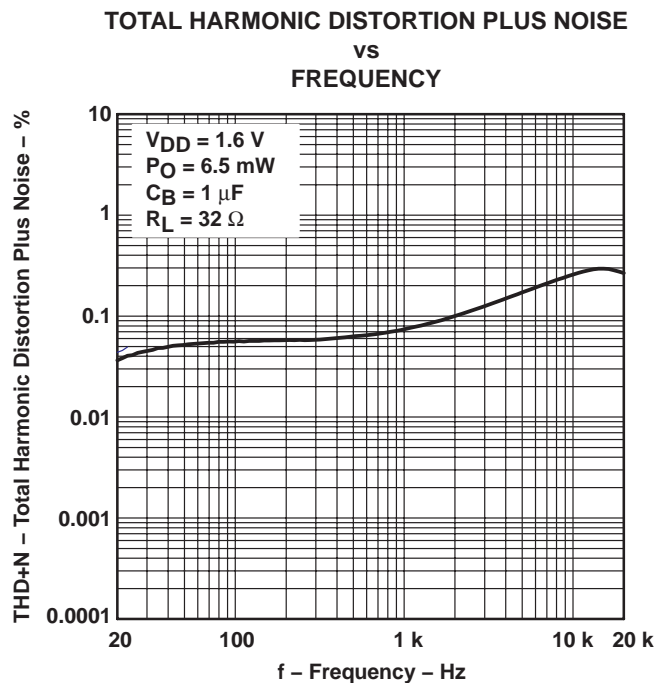

Figure 3

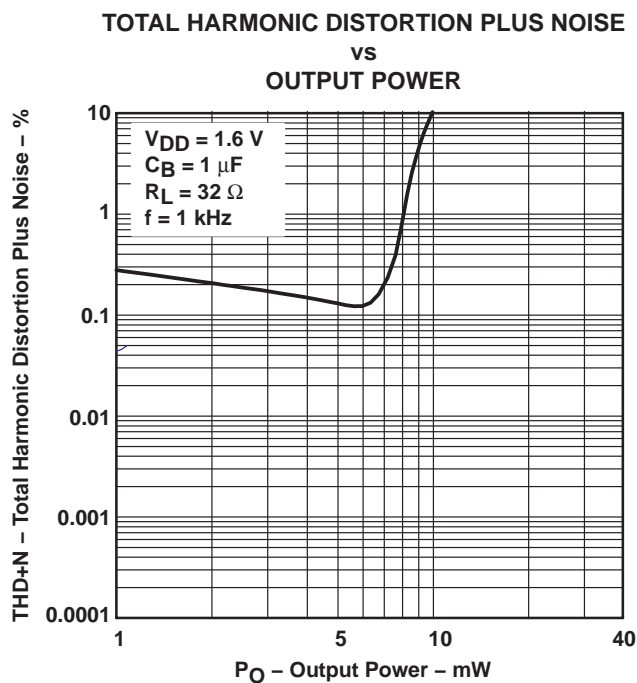

Figure 4

TYPICAL CHARACTERISTICS

TOTAL HARMONIC DISTORTION PLUS NOISE
vs
FREQUENCY

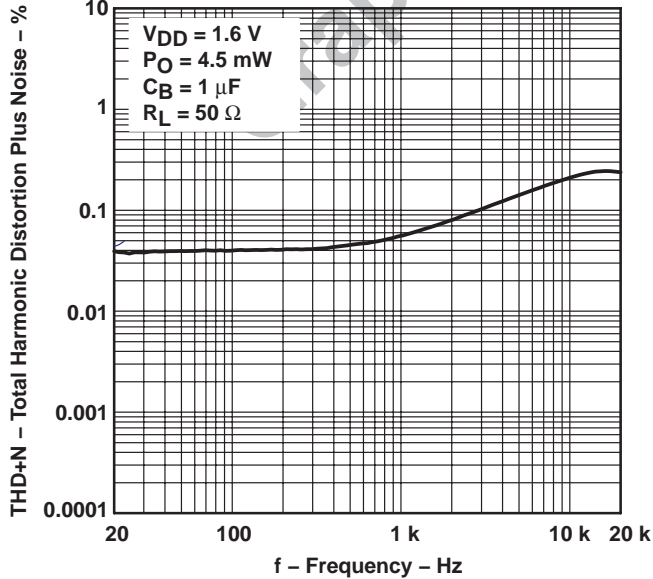

Figure 5

TOTAL HARMONIC DISTORTION PLUS NOISE
vs
OUTPUT POWER

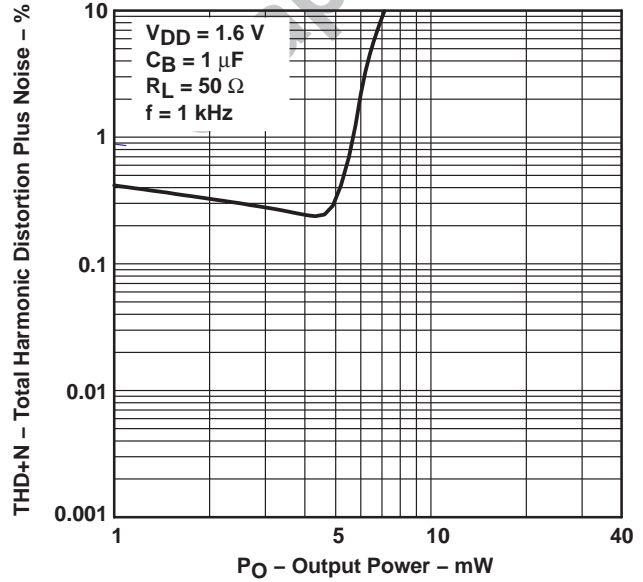

Figure 6

TOTAL HARMONIC DISTORTION PLUS NOISE
vs
FREQUENCY

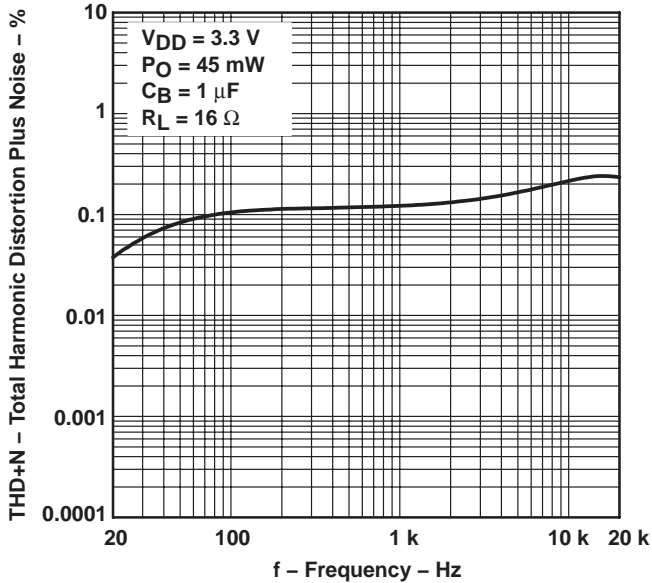

Figure 7

TOTAL HARMONIC DISTORTION PLUS NOISE
vs
OUTPUT POWER

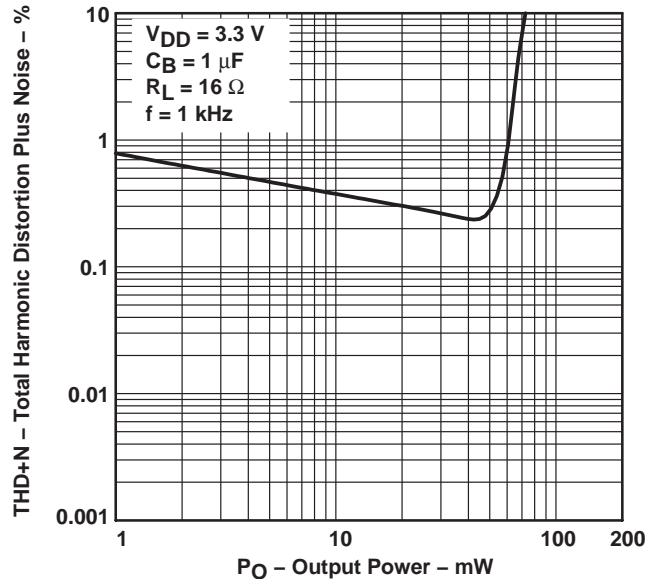

Figure 8

TPA6101A2
50-mW ULTRALOW-VOLTAGE, FIXED-GAIN STEREO HEADPHONE
AUDIO POWER AMPLIFIER

SLOS331B – AUGUST 2000 – REVISED SEPTEMBER 2004

TYPICAL CHARACTERISTICS

**TOTAL HARMONIC DISTORTION PLUS NOISE
vs
FREQUENCY**

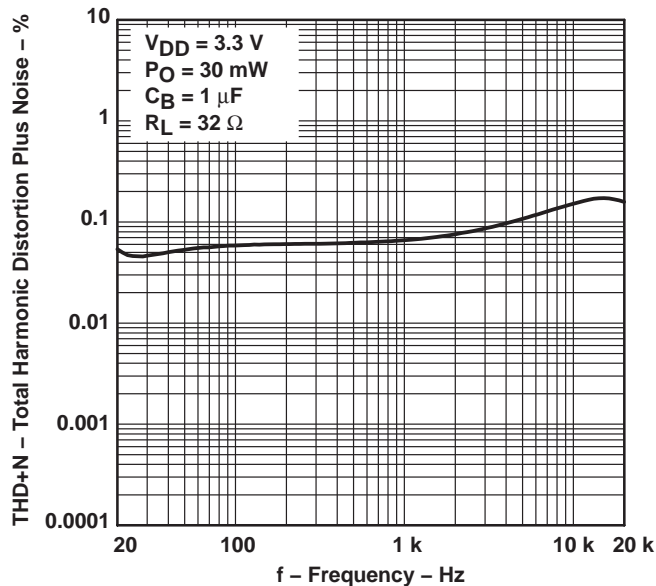

Figure 9

**TOTAL HARMONIC DISTORTION PLUS NOISE
vs
OUTPUT POWER**

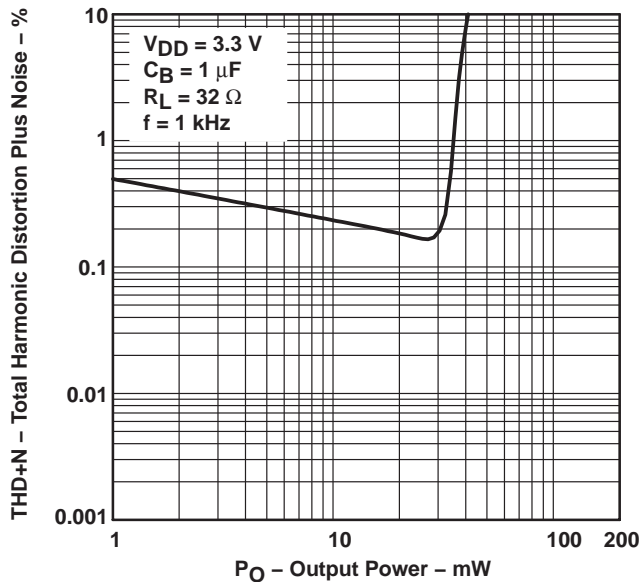

Figure 10

**TOTAL HARMONIC DISTORTION PLUS NOISE
vs
FREQUENCY**

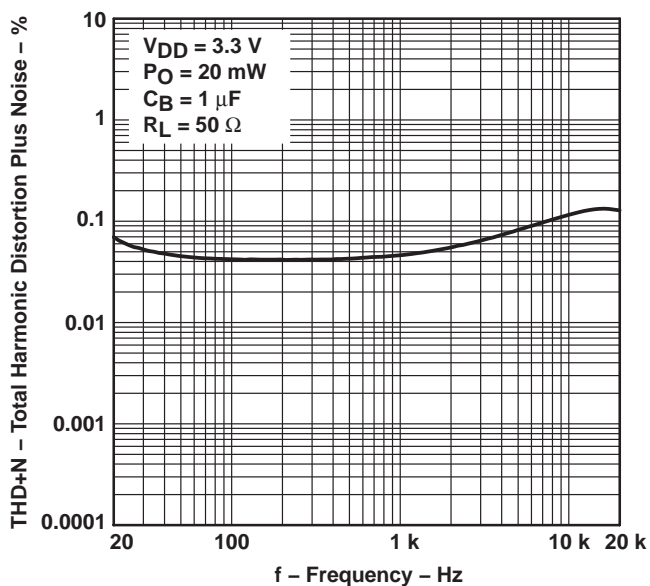

Figure 11

**TOTAL HARMONIC DISTORTION PLUS NOISE
vs
OUTPUT POWER**

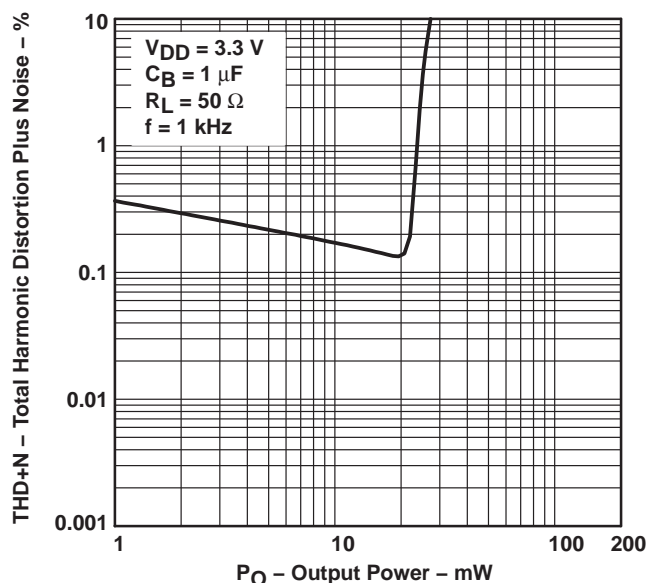

Figure 12

TYPICAL CHARACTERISTICS

TOTAL HARMONIC DISTORTION PLUS NOISE
vs
OUTPUT VOLTAGE

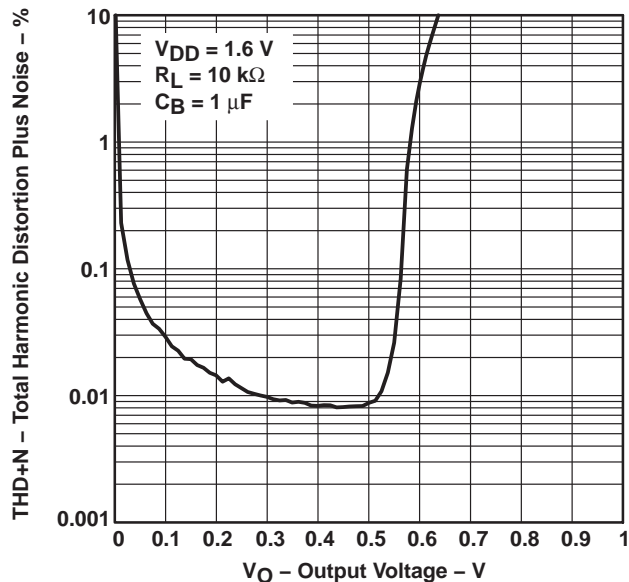

Figure 13

TOTAL HARMONIC DISTORTION PLUS NOISE
vs
OUTPUT VOLTAGE

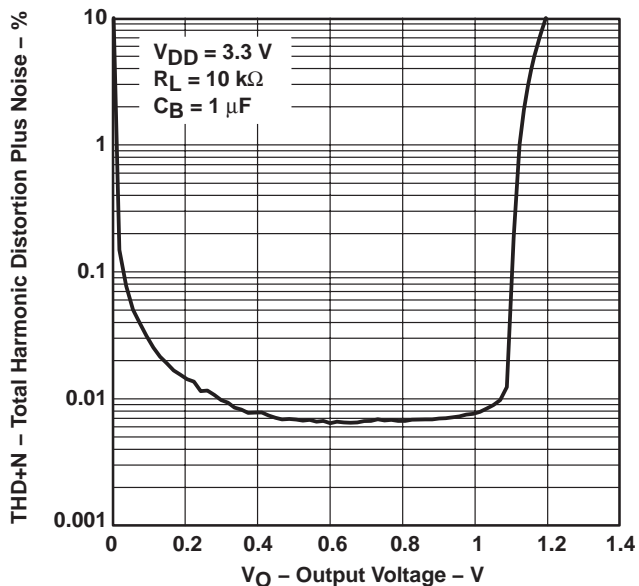

Figure 14

OUTPUT POWER
vs
LOAD RESISTANCE

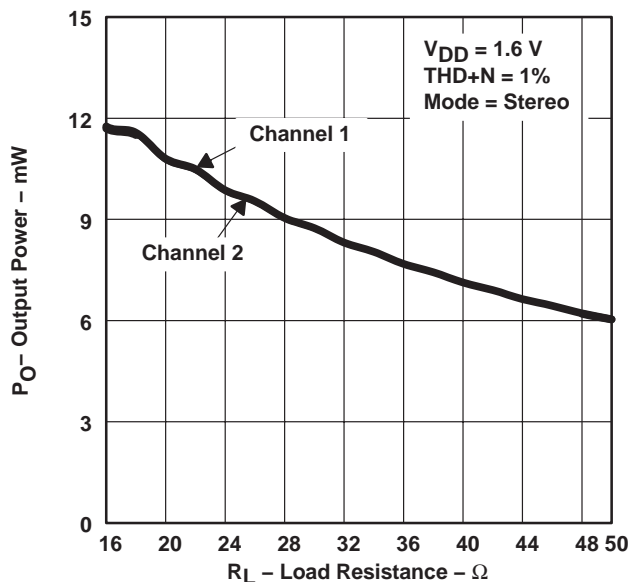

Figure 15

OUTPUT POWER
vs
LOAD RESISTANCE

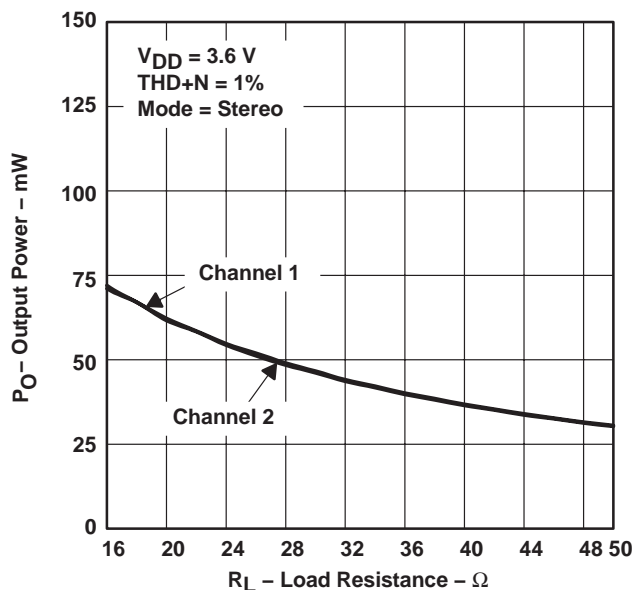
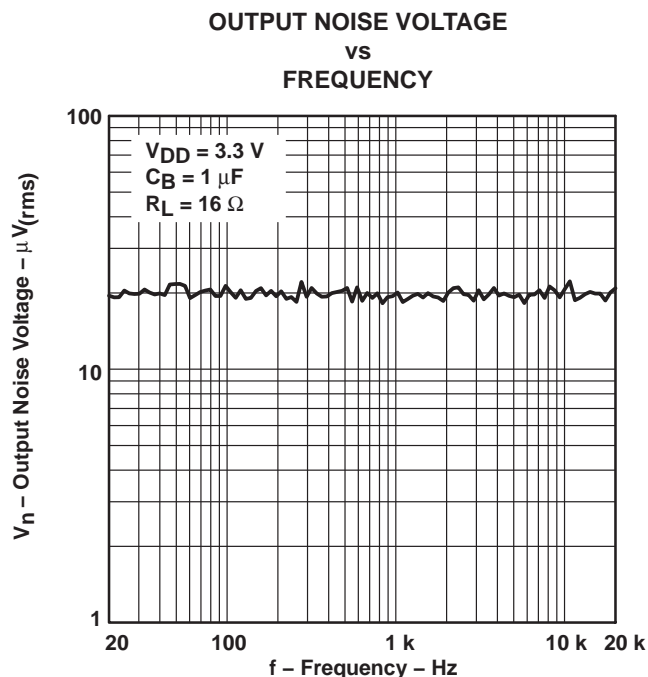
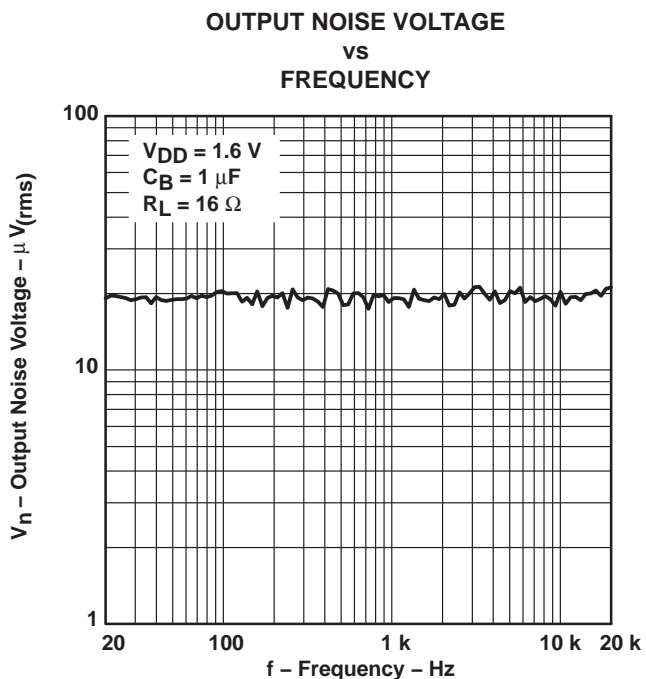
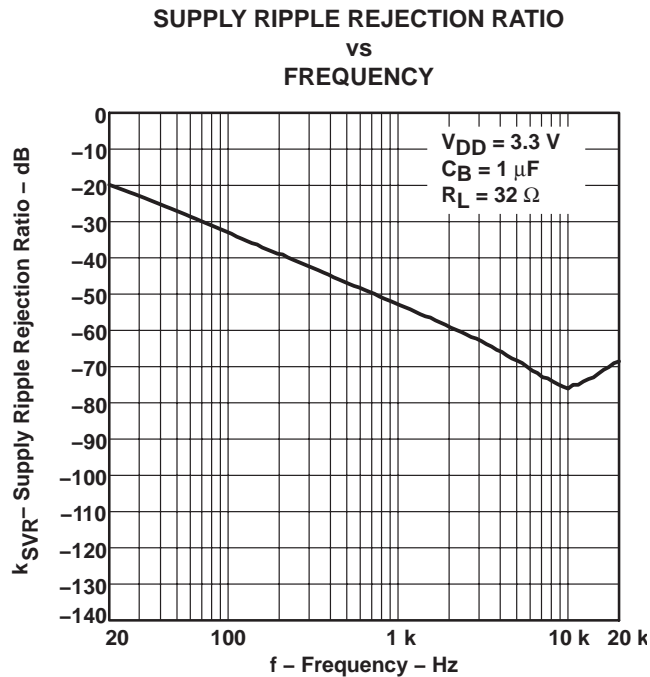
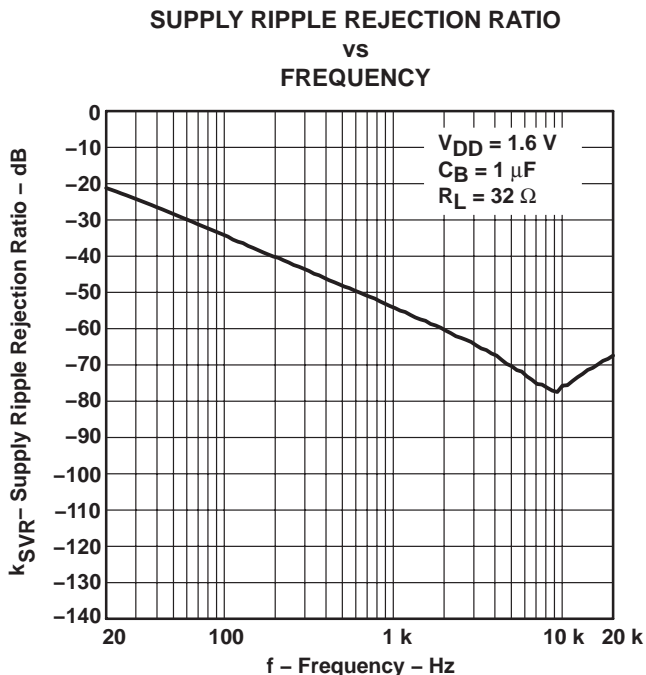

Figure 16

TPA6101A2
50-mW ULTRALOW-VOLTAGE, FIXED-GAIN STEREO HEADPHONE
AUDIO POWER AMPLIFIER

SLOS331B – AUGUST 2000 – REVISED SEPTEMBER 2004

TYPICAL CHARACTERISTICS



TYPICAL CHARACTERISTICS

CROSSTALK
vs
FREQUENCY

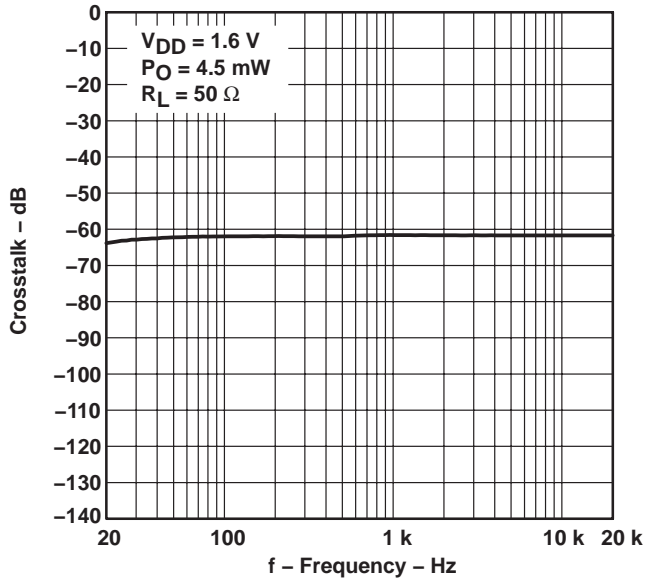

Figure 21

CROSSTALK
vs
FREQUENCY

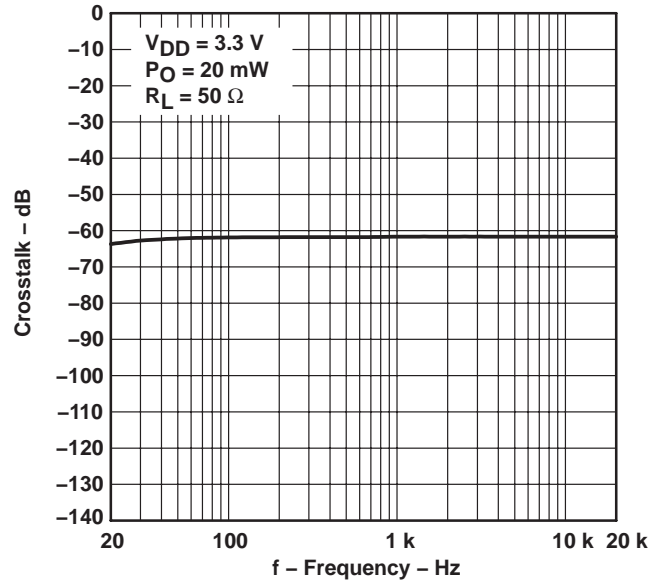

Figure 22

CLOSED-LOOP GAIN AND PHASE
vs
FREQUENCY

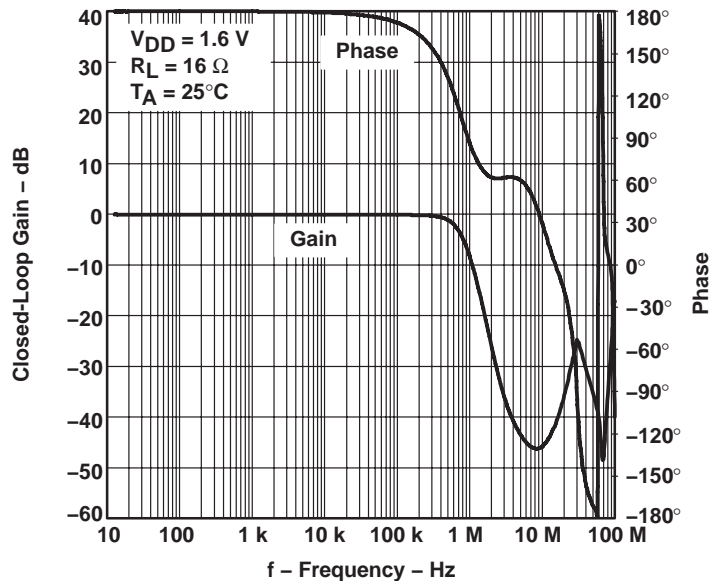

Figure 23

TYPICAL CHARACTERISTICS

**CLOSED-LOOP GAIN AND PHASE
 vs
 FREQUENCY**

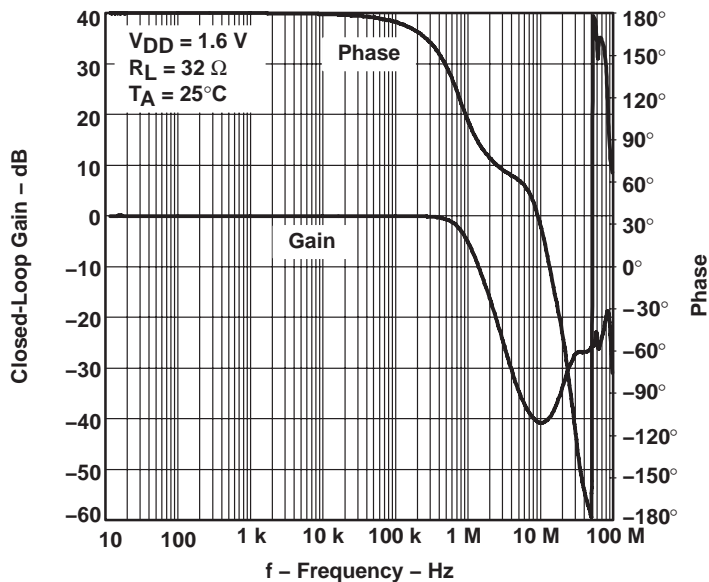

Figure 24

**CLOSED-LOOP GAIN AND PHASE
 vs
 FREQUENCY**

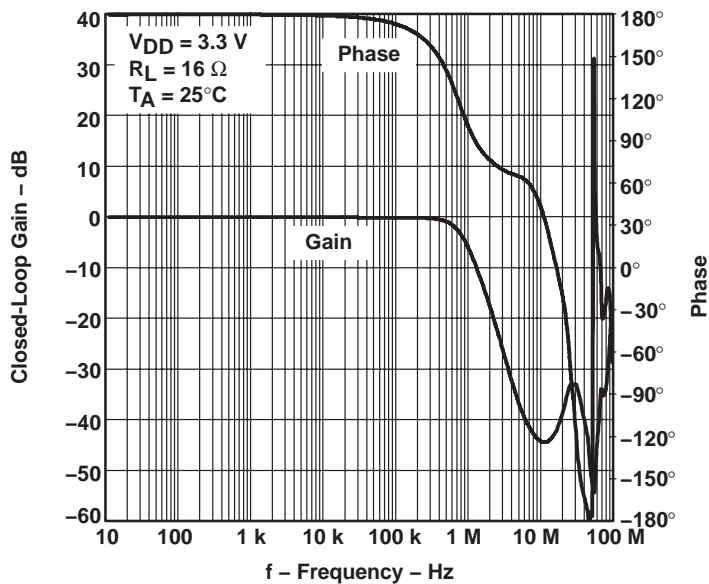

Figure 25

TPA6101A2
50-mW ULTRALOW-VOLTAGE, FIXED-GAIN STEREO HEADPHONE
AUDIO POWER AMPLIFIER

SLOS331B – AUGUST 2000 – REVISED SEPTEMBER 2004

TYPICAL CHARACTERISTICS

CLOSED-LOOP GAIN AND PHASE
vs
FREQUENCY

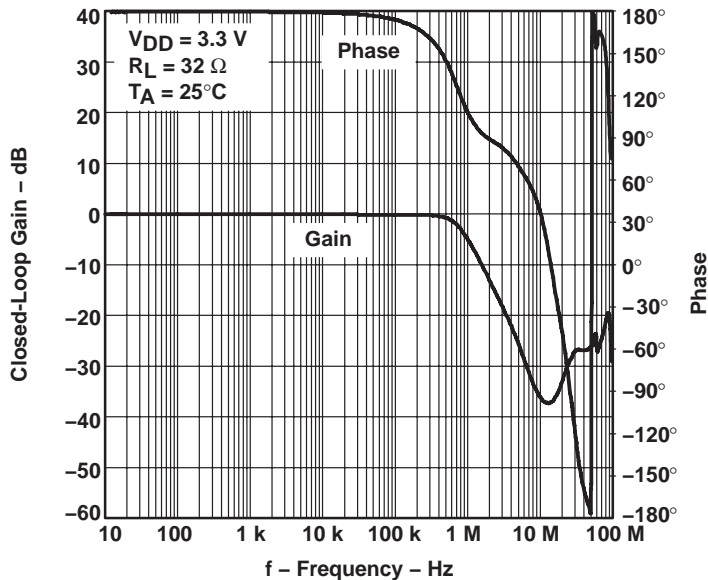

Figure 26

SUPPLY CURRENT
vs
SUPPLY VOLTAGE

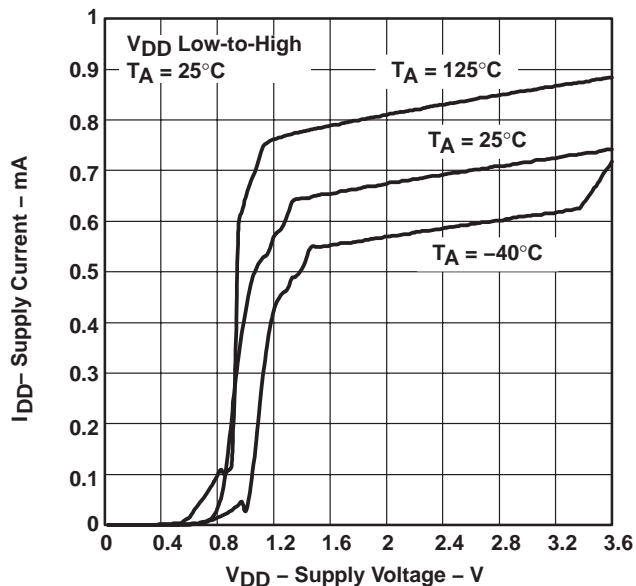

Figure 27

POWER DISSIPATION
vs
OUTPUT POWER

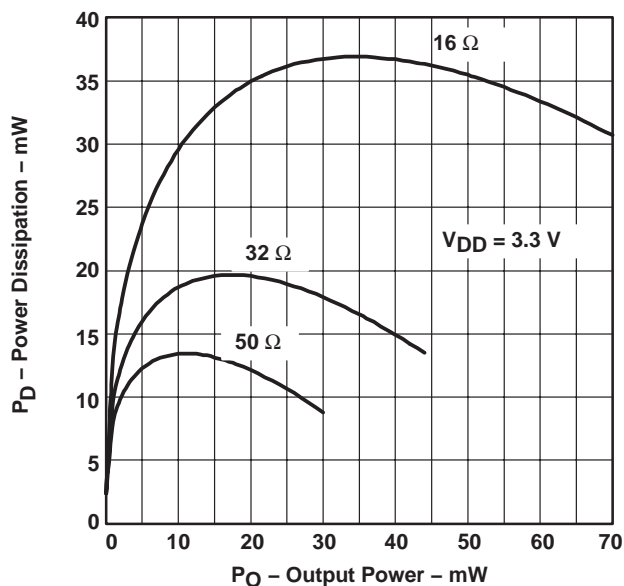

Figure 28



APPLICATION INFORMATION

input capacitor, C_I

In the typical application, an input capacitor (C_I) is required to allow the amplifier to bias the input signal to the proper dc level for optimum operation. In this case, C_I and R_I form a high-pass filter with the corner frequency determined in equation 1. R_I is set internally and is fixed at 80 k Ω .

$$f_c = \frac{1}{2\pi R_I C_I} \quad (1)$$

The value of C_I is important to consider, as it directly affects the bass (low frequency) performance of the circuit. Consider the example where the specification calls for a flat-bass response down to 20 Hz. Equation 1 is reconfigured as equation 2.

$$C_I = \frac{1}{2\pi R_I f_c} \quad (2)$$

In this example, C_I is approximately 0.1 μ F. A further consideration for this capacitor is the leakage path from the input source through the input network (R_I , C_I) and the feedback resistor (R_F) to the load. This leakage current creates a dc-offset voltage at the input to the amplifier that reduces useful headroom. For this reason a low-leakage tantalum or ceramic capacitor is the best choice. When polarized capacitors are used, the positive side of the capacitor should face the amplifier input in most applications, as the dc level there is held at $V_{DD}/4$, which is likely higher than the source dc level. It is important to confirm the capacitor polarity in the application.

power supply decoupling, C_S

The TPA6101A2 is a high-performance CMOS audio amplifier that requires adequate power supply decoupling to ensure that the output total harmonic distortion (THD) is as low as possible. Power supply decoupling also prevents oscillations for long lead lengths between the amplifier and the speaker. The optimum decoupling is achieved by using two capacitors of different types that target different types of noise on the power supply leads. For higher frequency transients, spikes, or digital hash on the line, a good low equivalent-series-resistance (ESR) ceramic capacitor, typically 0.1 μ F, placed as close as possible to the device V_{DD} lead, works best. For filtering lower-frequency noise signals, a larger, aluminum-electrolytic capacitor of 10 μ F or greater placed near the power amplifier is recommended.

midrail bypass capacitor, C_B

The midrail bypass capacitor (C_B) serves several important functions. During start-up, C_B determines the rate at which the amplifier starts up. This helps to push the start-up pop noise into the subaudible range (so low it can not be heard). The second function is to reduce noise produced by the power supply caused by coupling into the output drive signal. This noise is from the midrail generation circuit internal to the amplifier. The capacitor is fed from a 55-k Ω source inside the amplifier. To keep the start-up pop as low as possible, the relationship shown in equation 3 should be maintained.

$$\frac{1}{(C_B \times 55 \text{ k}\Omega)} \leq \frac{1}{(C_I R_I)} \quad (3)$$

As an example, consider a circuit where C_B is 1 μ F, C_I is 0.1 μ F, and R_I is 80 k Ω . Inserting these values into the equation 3 results in: $18.18 \leq 125$ which satisfies the rule. Bypass capacitor (C_B) values of 0.47- μ F to 1- μ F ceramic or tantalum low-ESR capacitors are recommended for the best THD and noise performance.

APPLICATION INFORMATION

output coupling capacitor, C_C

In the typical single-supply, single-ended (SE) configuration, an output coupling capacitor (C_C) is required to block the dc bias at the output of the amplifier, thus preventing dc currents in the load. As with the input coupling capacitor, the output coupling capacitor and impedance of the load from a high-pass filter is governed by equation 4.

$$f_c = \frac{1}{2\pi R_L C_C} \quad (4)$$

The main disadvantage, from a performance standpoint, is that the typically small-load impedances drive the low-frequency corner higher. Large values of C_C are required to pass low-frequencies into the load. Consider the example where a C_C of 68 μF is chosen and loads vary from 32 Ω to 47 k Ω . Table 1 summarizes the frequency response characteristics of each configuration.

Table 1. Common Load Impedances vs Low-Frequency Output Characteristics in SE Mode

R_L	C_C	LOWEST FREQUENCY
32 Ω	68 μF	73 Hz
10,000 Ω	68 μF	0.23 Hz
47,000 Ω	68 μF	0.05 Hz

As Table 1 indicates, headphone response is adequate and drive into line level inputs (a home stereo for example) is very good.

The output coupling capacitor required in single-supply SE mode also places additional constraints on the selection of other components in the amplifier circuit. With the rules described earlier still valid, add the following relationship:

$$\frac{1}{(C_B \times 55 \text{ k}\Omega)} \leq \frac{1}{(C_I R_I)} \ll \frac{1}{R_L C_C} \quad (5)$$

using low-ESR capacitors

Low-ESR capacitors are recommended throughout this application. A real capacitor can be modeled simply as a resistor in series with an ideal capacitor. The voltage drop across this resistor minimizes the beneficial effects of the capacitor in the circuit. The lower the equivalent value of this resistance, the more the real capacitor behaves like an ideal capacitor.

3.3-V versus 1.6-V operation

The TPA6101A2 was designed for operation over a supply range of 1.6 V to 3.6 V. There are no special considerations for 1.6-V versus 3.3-V operation as far as supply bypassing, gain setting, or stability. Supply current is slightly reduced from 0.75 mA (typical) to 0.65 mA (typical). The most important consideration is that of output power. Each amplifier can produce a maximum output voltage swing within a few hundred millivolts of the rails with a 10-k Ω load. However, this voltage swing decreases as the load resistance decreases and the $r_{DS(on)}$ as the output stage transistors becomes more significant. For example, for a 32- Ω load, the maximum peak output voltage with $V_{DD} = 1.6 \text{ V}$ is approximately 0.7 V with no clipping distortion. This reduced voltage swing effectively reduces the maximum undistorted output power.

TPA6101A2
50-mW ULTRALOW-VOLTAGE, FIXED-GAIN STEREO HEADPHONE
AUDIO POWER AMPLIFIER

SLOS331B – AUGUST 2000 – REVISED SEPTEMBER 2004

MECHANICAL DATA

D (R-PDSO-G)**

PLASTIC SMALL-OUTLINE PACKAGE

14 PIN SHOWN

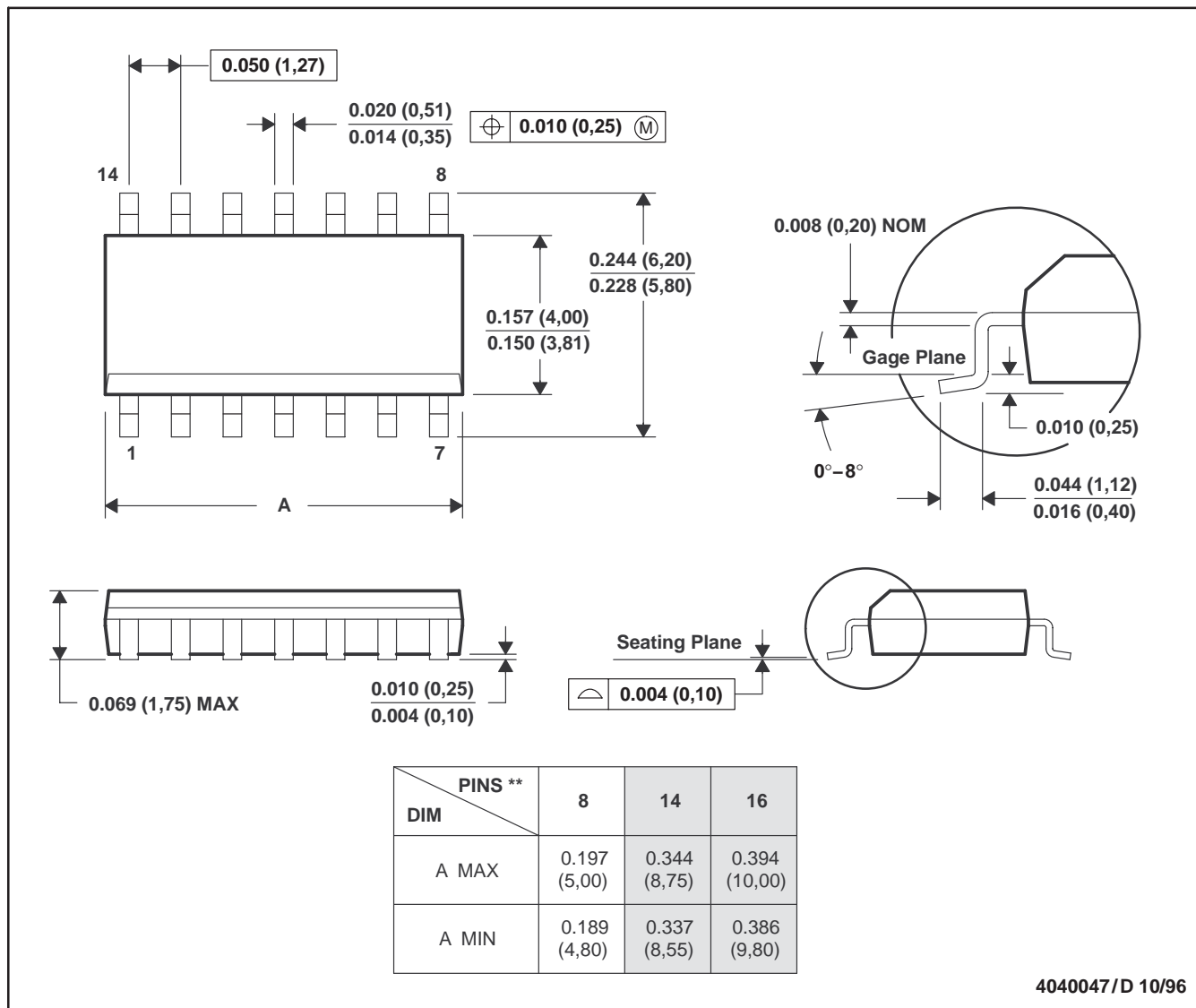

- NOTES: A. All linear dimensions are in inches (millimeters).
 B. This drawing is subject to change without notice.
 C. Body dimensions do not include mold flash or protrusion, not to exceed 0.006 (0,15).

TPA6101A2
50-mW ULTRALOW-VOLTAGE, FIXED-GAIN STEREO HEADPHONE
AUDIO POWER AMPLIFIER

SLOS331B – AUGUST 2000 – REVISED SEPTEMBER 2004

MECHANICAL INFORMATION

DGK (R-PDSO-G8)

PLASTIC SMALL-OUTLINE PACKAGE

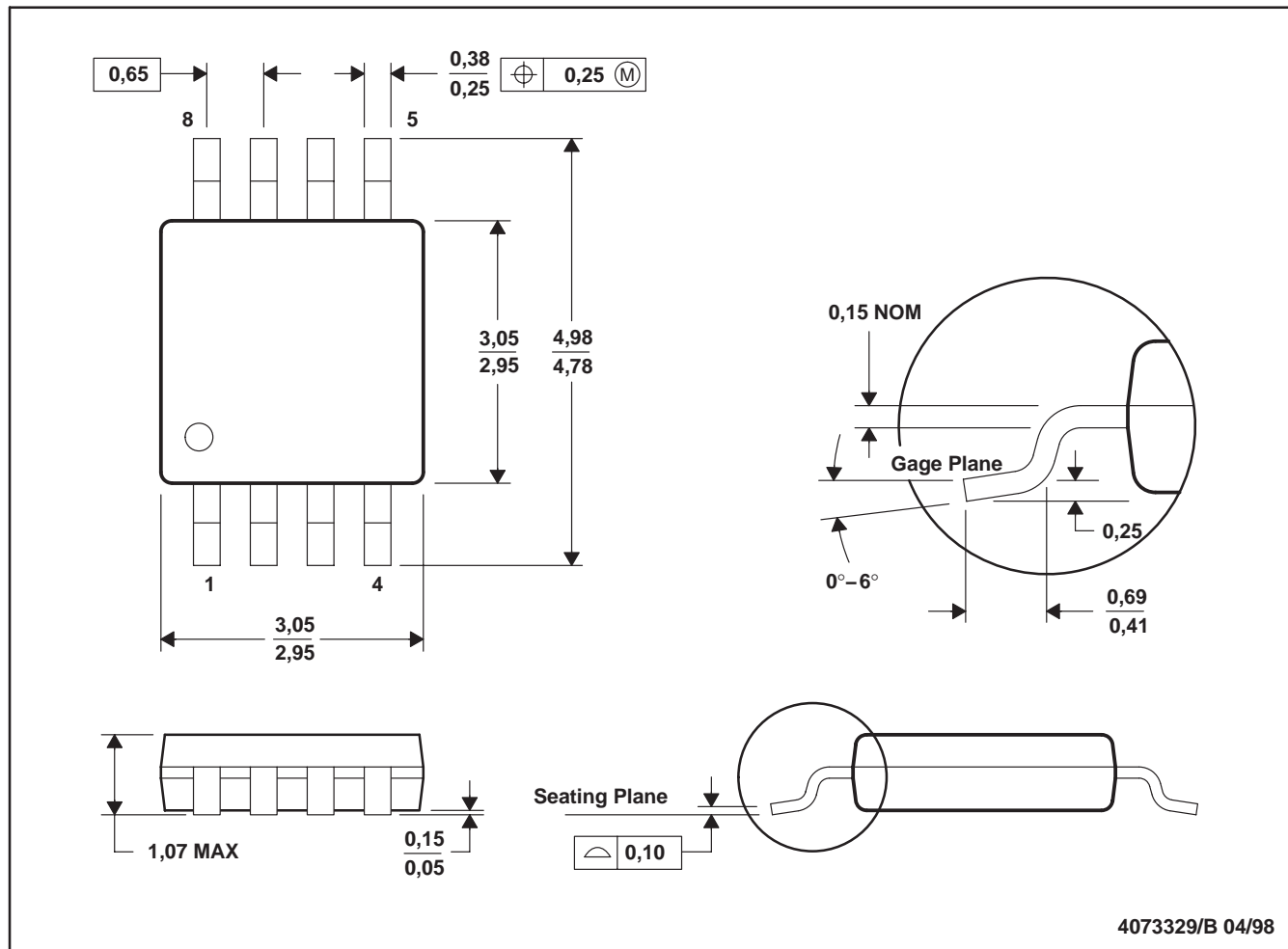

- NOTES: A. All linear dimensions are in millimeters.
 B. This drawing is subject to change without notice.
 C. Body dimensions do not include mold flash or protrusion.
 D. Falls within JEDEC MO-187

DGK (S-PDSO-G8)

PLASTIC SMALL-OUTLINE PACKAGE

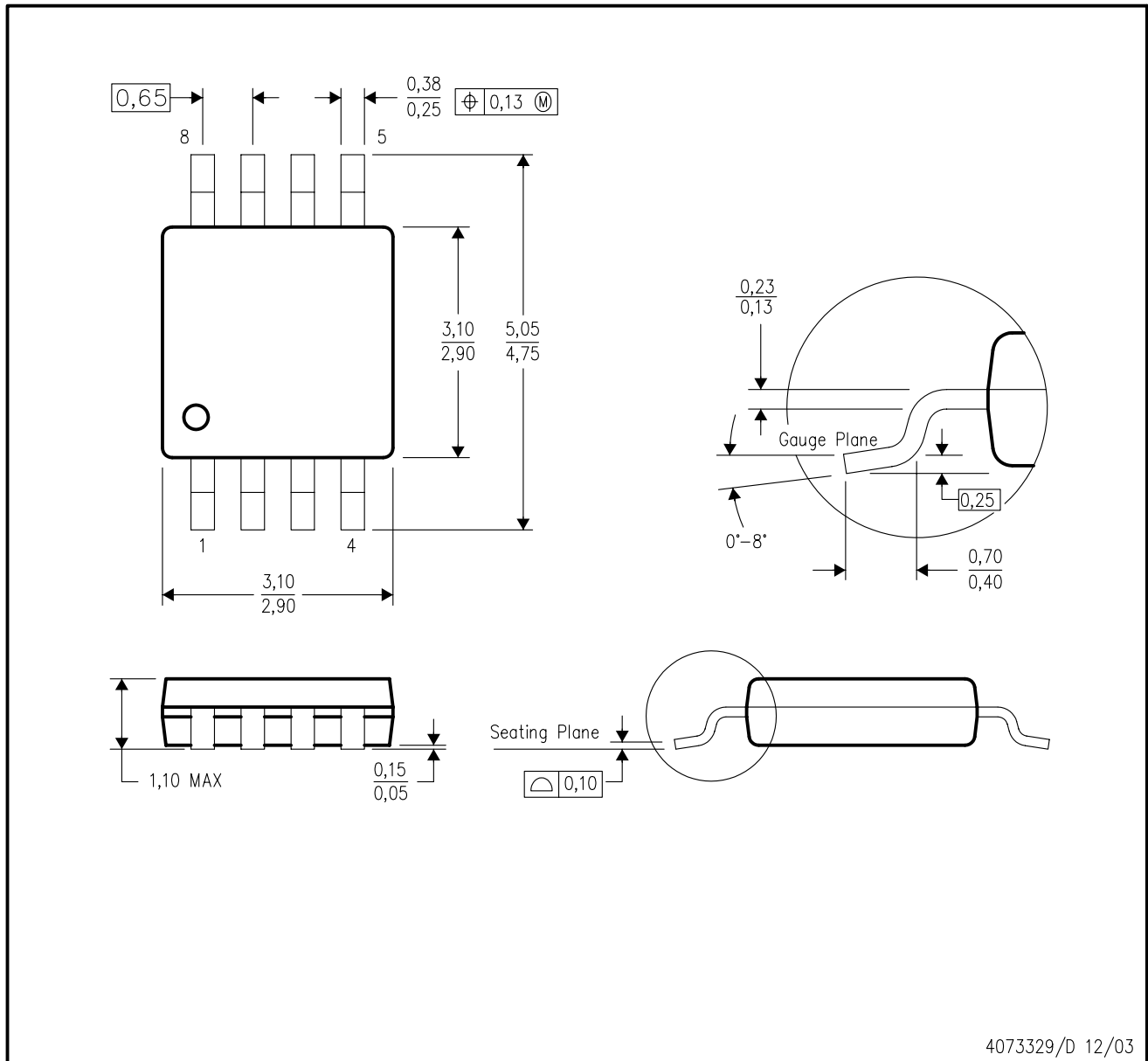

4073329/D 12/03

- NOTES:
- A. All linear dimensions are in millimeters.
 - B. This drawing is subject to change without notice.
 - C. Body dimensions do not include mold flash or protrusion.
 - D. Falls within JEDEC MO-187 variation AA.

D (R-PDSO-G8)

PLASTIC SMALL-OUTLINE PACKAGE

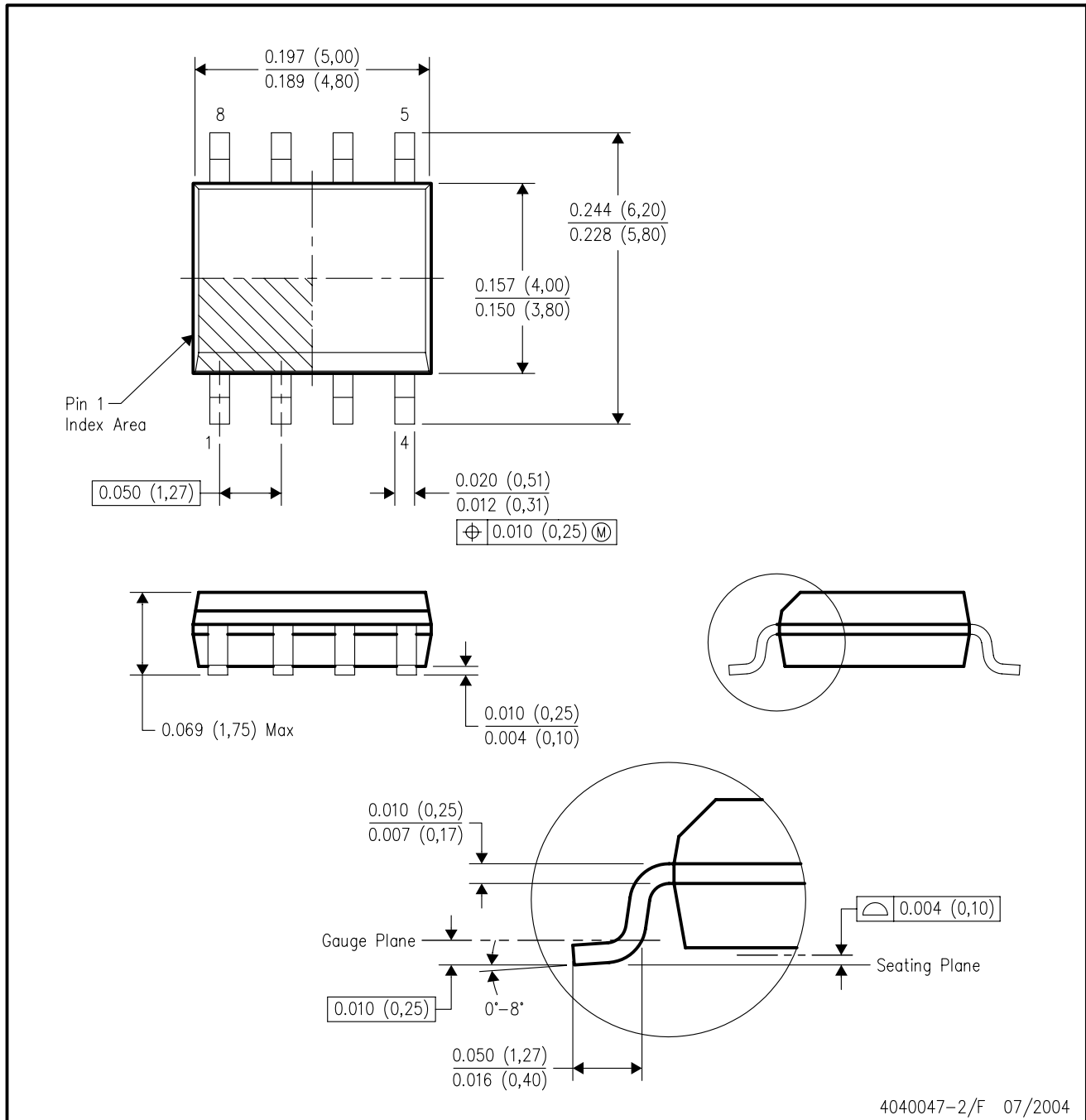

- NOTES:
- A. All linear dimensions are in inches (millimeters).
 - B. This drawing is subject to change without notice.
 - C. Body dimensions do not include mold flash or protrusion not to exceed 0.006 (0,15).
 - D. Falls within JEDEC MS-012 variation AA.

IMPORTANT NOTICE

Texas Instruments Incorporated and its subsidiaries (TI) reserve the right to make corrections, modifications, enhancements, improvements, and other changes to its products and services at any time and to discontinue any product or service without notice. Customers should obtain the latest relevant information before placing orders and should verify that such information is current and complete. All products are sold subject to TI's terms and conditions of sale supplied at the time of order acknowledgment.

TI warrants performance of its hardware products to the specifications applicable at the time of sale in accordance with TI's standard warranty. Testing and other quality control techniques are used to the extent TI deems necessary to support this warranty. Except where mandated by government requirements, testing of all parameters of each product is not necessarily performed.

TI assumes no liability for applications assistance or customer product design. Customers are responsible for their products and applications using TI components. To minimize the risks associated with customer products and applications, customers should provide adequate design and operating safeguards.

TI does not warrant or represent that any license, either express or implied, is granted under any TI patent right, copyright, mask work right, or other TI intellectual property right relating to any combination, machine, or process in which TI products or services are used. Information published by TI regarding third-party products or services does not constitute a license from TI to use such products or services or a warranty or endorsement thereof. Use of such information may require a license from a third party under the patents or other intellectual property of the third party, or a license from TI under the patents or other intellectual property of TI.

Reproduction of information in TI data books or data sheets is permissible only if reproduction is without alteration and is accompanied by all associated warranties, conditions, limitations, and notices. Reproduction of this information with alteration is an unfair and deceptive business practice. TI is not responsible or liable for such altered documentation.

Resale of TI products or services with statements different from or beyond the parameters stated by TI for that product or service voids all express and any implied warranties for the associated TI product or service and is an unfair and deceptive business practice. TI is not responsible or liable for any such statements.

Following are URLs where you can obtain information on other Texas Instruments products and application solutions:

Products		Applications	
Amplifiers	amplifier.ti.com	Audio	www.ti.com/audio
Data Converters	dataconverter.ti.com	Automotive	www.ti.com/automotive
DSP	dsp.ti.com	Broadband	www.ti.com/broadband
Interface	interface.ti.com	Digital Control	www.ti.com/digitalcontrol
Logic	logic.ti.com	Military	www.ti.com/military
Power Mgmt	power.ti.com	Optical Networking	www.ti.com/opticalnetwork
Microcontrollers	microcontroller.ti.com	Security	www.ti.com/security
		Telephony	www.ti.com/telephony
		Video & Imaging	www.ti.com/video
		Wireless	www.ti.com/wireless

Mailing Address: Texas Instruments
Post Office Box 655303 Dallas, Texas 75265