

- 150-mA Low-Dropout Regulator
- Output Voltage: 5 V, 3.8 V, 3.3 V, 3.0 V, 2.8 V, 2.7 V, 2.5 V, 1.8 V, 1.6 V and Variable
- Dropout Voltage, Typically 300 mV at 150 mA
- Thermal Protection
- Over Current Limitation
- Less Than 2- μ A Quiescent Current in Shutdown Mode
- -40°C to 125°C Operating Junction Temperature Range
- 5-Pin SOT-23 (DBV) Package



description

The TPS763xx family of low-dropout (LDO) voltage regulators offers the benefits of low-dropout voltage, low-power operation, and miniaturized packaging. These regulators feature low dropout voltages and quiescent currents compared to conventional LDO regulators. Offered in a 5-terminal, small outline integrated-circuit SOT-23 package, the TPS763xx series devices are ideal for cost-sensitive designs and for applications where board space is at a premium.

A combination of new circuit design and process innovation has enabled the usual pnp pass transistor to be replaced by a PMOS pass element. Because the PMOS pass element behaves as a low-value resistor, the dropout voltage is very low—typically 300 mV at 150 mA of load current (TPS76333)—and is directly proportional to the load current. Since the PMOS pass element is a voltage-driven device, the quiescent current is very low (140 μ A maximum) and is stable over the entire range of output load current (0 mA to 150 mA). Intended for use in portable systems such as laptops and cellular phones, the low-dropout voltage feature and low-power operation result in a significant increase in system battery operating life.

The TPS763xx also features a logic-enabled sleep mode to shut down the regulator, reducing quiescent current to 1 μ A maximum at $T_J = 25^\circ\text{C}$. The TPS763xx is offered in 1.6-V, 1.8-V, 2.5-V, 2.7-V, 2.8-V, 3.0-V, 3.3-V, 3.8-V, and 5-V fixed-voltage versions and in a variable version (programmable over the range of 1.5 V to 6.5 V).

AVAILABLE OPTIONS

T_J	VOLTAGE	PACKAGE	PART NUMBER		SYMBOL
-40°C to 125°C	Variable	SOT-23 (DBV)	TPS76301DBVT ⁽¹⁾	TPS76301DBVR ⁽²⁾	PAZI
	1.6 V		TPS76316DBVT	TPS76316DBVR	PBHI
	1.8 V		TPS76318DBVT	TPS76318DBVR	PBAI
	2.5 V		TPS76325DBVT	TPS76325DBVR	PBBI
	2.7 V		TPS76327DBVT	TPS76327DBVR	PBCI
	2.8 V		TPS76328DBVT	TPS76328DBVR	PBDI
	3.0 V		TPS76330DBVT	TPS76330DBVR	PBII
	3.3 V		TPS76333DBVT	TPS76333DBVR	PBEI
	3.8 V		TPS76338DBVT	TPS76338DBVR	PBFI
	5.0 V		TPS76350DBVT	TPS76350DBVR	PBGI

(1) The DBVT passive indicates tape and reel of 250 parts.

(2) The DBVR passive indicates tape and reel of 3000 parts.



Please be aware that an important notice concerning availability, standard warranty, and use in critical applications of Texas Instruments semiconductor products and disclaimers thereto appears at the end of this data sheet.

All trademarks are the property of their respective owners.

FUNCTIONAL BLOCK DIAGRAM

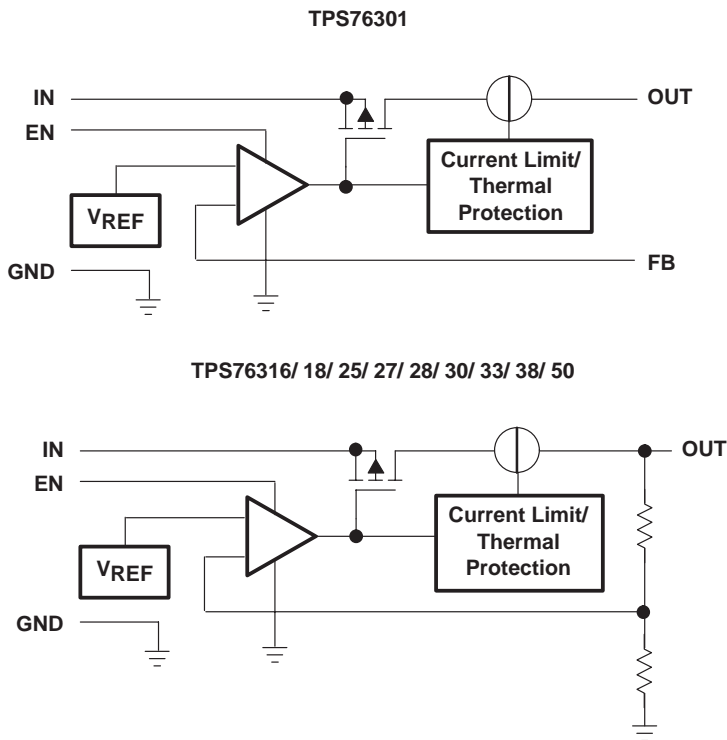

Terminal Functions

TERMINAL NAME	DESCRIPTION
GND	Ground
EN	Enable input
FB	Feedback voltage (TPS76301 only)
IN	Input supply voltage
NC	No connection (fixed-voltage option only)
OUT	Regulated output voltage

absolute maximum ratings over operating free-air temperature range (unless otherwise noted)¹

Input voltage range ⁽²⁾	–0.3 V to 10 V
Voltage range at EN	–0.3 V to $V_I + 0.3$ V
Voltage on OUT, FB	7 V
Peak output current	Internally limited
ESD rating, HBM	2 kV
Continuous total power dissipation	See Dissipation Rating Tables
Operating junction temperature range, T_J	–40°C to 150°C
Storage temperature range, T_{stg}	–65°C to 150°C

- (1) Stresses beyond those listed under *absolute maximum ratings* may cause permanent damage to the device. These are stress ratings only, and functional operation of the device at these or any other conditions beyond those indicated under *recommended operating conditions* is not implied. Exposure to absolute-maximum-rated conditions for extended periods may affect device reliability.
- (2) All voltage values are with respect to network ground terminal.

DISSIPATION RATING TABLE

BOARD	PACKAGE	$R_{\theta JC}$	$R_{\theta JA}$	DERATING FACTOR ABOVE $T_A = 25^\circ\text{C}$	$T_A \leq 25^\circ\text{C}$ POWER RATING	$T_A = 70^\circ\text{C}$ POWER RATING	$T_A = 85^\circ\text{C}$ POWER RATING
Low K ⁽¹⁾	DBV	65.8 °C/W	259 °C/W	3.9 mW/°C	386 mW	212 mW	154 mW
High K ⁽²⁾	DBV	65.8 °C/W	180 °C/W	5.6 mW/°C	555 mW	305 mW	222 mW

- (1) The JEDEC Low K (1s) board design used to derive this data was a 3 inch x 3 inch, two layer board with 2 ounce copper traces on top of the board.
- (2) The JEDEC High K (2s2p) board design used to derive this data was a 3 inch x 3 inch, multilayer board with 1 ounce internal power and ground planes and 2 ounce copper traces on top and bottom of the board.

recommended operating conditions

	MIN	NOM	MAX	UNIT
Input voltage, V_I ⁽¹⁾	2.7		10	V
Continuous output current, I_O		0	150	mA
Operating junction temperature, T_J	–40		125	°C

- (1) To calculate the minimum input voltage for your maximum output current, use the following equation:

$$V_{I(\min)} = V_{O(\max)} + V_{DO(\max \text{ load})}$$

TPS76301, TPS76316, TPS76318, TPS76325, TPS76327
TPS76328, TPS76330, TPS76333, TPS76338, TPS76350
LOW-POWER 150-mA LOW-DROPOUT LINEAR REGULATORS



SLVS181H – DECEMBER 1998 – REVISED JANUARY 2004

electrical characteristics over recommended operating free-air temperature range,
 $V_I = V_O(\text{typ}) + 1 \text{ V}$, $I_O = 1 \text{ mA}$, $EN = IN$, $C_O = 4.7 \mu\text{F}$ (unless otherwise noted)

PARAMETER		TEST CONDITIONS		MIN	TYP	MAX	UNIT	
V_O	Output voltage	TPS76301	$3.25 \text{ V} > V_I \geq 2.7 \text{ V}$, $2.5 \text{ V} \geq V_O \geq 1.5 \text{ V}$,	$I_O = 1 \text{ mA}$ to 75 mA , $T_J = 25^\circ\text{C}$	$0.98 V_O$	V_O	$1.02 V_O$	V
			$3.25 \text{ V} > V_I \geq 2.7 \text{ V}$, $2.5 \text{ V} \geq V_O \geq 1.5 \text{ V}$	$I_O = 1 \text{ mA}$ to 75 mA ,	$0.97 V_O$	V_O	$1.03 V_O$	
			$V_I \geq 3.25 \text{ V}$, $5 \text{ V} \geq V_O \geq 1.5 \text{ V}$	$I_O = 1 \text{ mA}$ to 100 mA , $T_J = 25^\circ\text{C}$	$0.98 V_O$	V_O	$1.02 V_O$	
			$V_I \geq 3.25 \text{ V}$, $5 \text{ V} \geq V_O \geq 1.5 \text{ V}$	$I_O = 1 \text{ mA}$ to 100 mA ,	$0.97 V_O$	V_O	$1.03 V_O$	
			$V_I \geq 3.25 \text{ V}$, $5 \text{ V} \geq V_O \geq 1.5 \text{ V}$	$I_O = 1 \text{ mA}$ to 150 mA , $T_J = 25^\circ\text{C}$	$0.975 V_O$	V_O	$1.025 V_O$	
			$V_I \geq 3.25 \text{ V}$, $5 \text{ V} \geq V_O \geq 1.5 \text{ V}$	$I_O = 1 \text{ mA}$ to 150 mA ,	$0.9625 V_O$	V_O	$1.0375 V_O$	
		TPS76316	$V_I = 2.7 \text{ V}$,	$1 \text{ mA} < I_O < 75 \text{ mA}$, $T_J = 25^\circ\text{C}$	1.568	1.6	1.632	V
			$V_I = 2.7 \text{ V}$,	$1 \text{ mA} < I_O < 75 \text{ mA}$	1.552	1.6	1.648	
			$V_I = 3.25 \text{ V}$,	$1 \text{ mA} < I_O < 100 \text{ mA}$, $T_J = 25^\circ\text{C}$	1.568	1.6	1.632	
			$V_I = 3.25 \text{ V}$,	$1 \text{ mA} < I_O < 100 \text{ mA}$	1.552	1.6	1.648	
			$V_I = 3.25 \text{ V}$,	$1 \text{ mA} < I_O < 150 \text{ mA}$, $T_J = 25^\circ\text{C}$	1.560	1.6	1.640	
			$V_I = 3.25 \text{ V}$,	$1 \text{ mA} < I_O < 150 \text{ mA}$	1.536	1.6	1.664	
		TPS76318	$V_I = 2.7 \text{ V}$,	$1 \text{ mA} < I_O < 75 \text{ mA}$, $T_J = 25^\circ\text{C}$	1.764	1.8	1.836	V
			$V_I = 2.7 \text{ V}$,	$1 \text{ mA} < I_O < 75 \text{ mA}$	1.746	1.8	1.854	
			$V_I = 3.25 \text{ V}$,	$1 \text{ mA} < I_O < 100 \text{ mA}$, $T_J = 25^\circ\text{C}$	1.764	1.8	1.836	
			$V_I = 3.25 \text{ V}$,	$1 \text{ mA} < I_O < 100 \text{ mA}$	1.746	1.8	1.854	
			$V_I = 3.25 \text{ V}$,	$1 \text{ mA} < I_O < 150 \text{ mA}$, $T_J = 25^\circ\text{C}$	1.755	1.8	1.845	
			$V_I = 3.25 \text{ V}$,	$1 \text{ mA} < I_O < 150 \text{ mA}$	1.733	1.8	1.867	
		TPS76325	$I_O = 1 \text{ mA}$ to 100 mA , $T_J = 25^\circ\text{C}$		2.45	2.5	2.55	V
			$I_O = 1 \text{ mA}$ to 100 mA		2.425	2.5	2.575	
			$I_O = 1 \text{ mA}$ to 150 mA , $T_J = 25^\circ\text{C}$		2.438	2.5	2.562	
			$I_O = 1 \text{ mA}$ to 150 mA		2.407	2.5	2.593	
		TPS76327	$I_O = 1 \text{ mA}$ to 100 mA , $T_J = 25^\circ\text{C}$		2.646	2.7	2.754	V
			$I_O = 1 \text{ mA}$ to 100 mA		2.619	2.7	2.781	
			$I_O = 1 \text{ mA}$ to 150 mA , $T_J = 25^\circ\text{C}$		2.632	2.7	2.767	
			$I_O = 1 \text{ mA}$ to 150 mA		2.599	2.7	2.801	
		TPS76328	$I_O = 1 \text{ mA}$ to 100 mA , $T_J = 25^\circ\text{C}$		2.744	2.8	2.856	V
			$I_O = 1 \text{ mA}$ to 100 mA		2.716	2.8	2.884	
			$I_O = 1 \text{ mA}$ to 150 mA , $T_J = 25^\circ\text{C}$		2.73	2.8	2.87	
			$I_O = 1 \text{ mA}$ to 150 mA		2.695	2.8	2.905	
TPS76330	$I_O = 1 \text{ mA}$ to 100 mA , $T_J = 25^\circ\text{C}$		2.94	3.0	3.06	V		
	$I_O = 1 \text{ mA}$ to 100 mA		2.91	3.0	3.09			
	$I_O = 1 \text{ mA}$ to 150 mA , $T_J = 25^\circ\text{C}$		2.925	3.0	3.075			
	$I_O = 1 \text{ mA}$ to 150 mA		2.888	3.0	3.112			

electrical characteristics over recommended operating free-air temperature range,
 $V_I = V_{O(\text{typ})} + 1 \text{ V}$, $I_O = 1 \text{ mA}$, $EN = IN$, $C_O = 4.7 \mu\text{F}$ (unless otherwise noted) (continued)

PARAMETER		TEST CONDITIONS	MIN	TYP	MAX	UNIT	
V_O	Output voltage	TPS76333	$I_O = 1 \text{ mA to } 100 \text{ mA}$, $T_J = 25^\circ\text{C}$		3.234	3.3	3.366
			$I_O = 1 \text{ mA to } 100 \text{ mA}$		3.201	3.3	3.399
			$I_O = 1 \text{ mA to } 150 \text{ mA}$, $T_J = 25^\circ\text{C}$		3.218	3.3	3.382
			$I_O = 1 \text{ mA to } 150 \text{ mA}$		3.177	3.3	3.423
		TPS76338	$I_O = 1 \text{ mA to } 100 \text{ mA}$, $T_J = 25^\circ\text{C}$		3.724	3.8	3.876
			$I_O = 1 \text{ mA to } 100 \text{ mA}$		3.705	3.8	3.895
			$I_O = 1 \text{ mA to } 150 \text{ mA}$, $T_J = 25^\circ\text{C}$		3.686	3.8	3.914
			$I_O = 1 \text{ mA to } 150 \text{ mA}$		3.667	3.8	3.933
		TPS76350	$I_O = 1 \text{ mA to } 100 \text{ mA}$, $T_J = 25^\circ\text{C}$		4.875	5	5.125
			$I_O = 1 \text{ mA to } 100 \text{ mA}$		4.825	5	5.175
			$I_O = 1 \text{ mA to } 150 \text{ mA}$, $T_J = 25^\circ\text{C}$		4.750	5	5.15
			$I_O = 1 \text{ mA to } 150 \text{ mA}$		4.80	5	5.20
$I_{(Q)}$	Quiescent current (GND terminal current)	$I_O = 0 \text{ to } 150 \text{ mA}$, $T_J = 25^\circ\text{C}$ (1)		85	100	μA	
		$I_O = 0 \text{ to } 150 \text{ mA}$ (2)			140		
	Standby current	$EN < 0.5 \text{ V}$, $T_J = 25^\circ\text{C}$		0.5	1	μA	
		$EN < 0.5 \text{ V}$			2		
V_n	Output noise voltage	BW = 300 Hz to 50 kHz, $C_O = 10 \mu\text{F}$ (2) $T_J = 25^\circ\text{C}$,		140		μV	
PSRR	Ripple rejection	f = 1 kHz, $C_O = 10 \mu\text{F}$, $T_J = 25^\circ\text{C}$ (2)		60		dB	
	Current limit	$T_J = 25^\circ\text{C}$ (3)		0.5	0.8	1.5	
	Output voltage line regulation ($\Delta V_O/V_O$) (see Note 3)	$V_O + 1 \text{ V} < V_I \leq 10 \text{ V}$, $V_I \geq 3.5 \text{ V}$, $T_J = 25^\circ\text{C}$		0.04	0.07	%/V	
		$V_O + 1 \text{ V} < V_I \leq 10 \text{ V}$, $V_I \geq 3.5 \text{ V}$			0.1		
V_{IH}	EN high level input	(2)		1.4	2	V	
V_{IL}	EN low level input	(2)		0.5	1.2		
I_I	EN input current	EN = 0 V		-0.01	-0.5	μA	
		EN = IN		-0.01	-0.5		

(1) Minimum IN operating voltage is 2.7 V or $V_{O(\text{typ})} + 1 \text{ V}$, whichever is greater.

(2) Test condition includes, output voltage $V_O=0$ volts (for variable device FB is shorted to V_O), and pulse duration = 10 mS.

(3) If $V_O < 2.5 \text{ V}$ and $V_{I\text{max}} = 10 \text{ V}$, $V_{I\text{min}} = 3.5 \text{ V}$:

$$\text{Line Reg. (mV)} = (\%/V) \times \frac{V_O(V_{I\text{max}} - 3.5 \text{ V})}{100} \times 1000$$

If $V_O > 2.5 \text{ V}$ and $V_{I\text{max}} = 10 \text{ V}$, $V_{I\text{min}} = V_O + 1 \text{ V}$:

$$\text{Line Reg. (mV)} = (\%/V) \times \frac{V_O(V_{I\text{max}} - (V_O + 1))}{100} \times 1000$$

**TPS76301, TPS76316, TPS76318, TPS76325, TPS76327
 TPS76328, TPS76330, TPS76333, TPS76338, TPS76350
 LOW-POWER 150-mA LOW-DROPOUT LINEAR REGULATORS**

SLVS181H – DECEMBER 1998 – REVISED JANUARY 2004

**electrical characteristics over recommended operating free-air temperature range,
 $V_I = V_{O(typ)} + 1\text{ V}$, $I_O = 1\text{ mA}$, $EN = IN$, $C_O = 4.7\text{ }\mu\text{F}$ (unless otherwise noted) (continued)**

PARAMETER		TEST CONDITIONS	MIN	TYP	MAX	UNIT	
V _{DO}	Dropout voltage	TPS76325	I _O = 0 mA, T _J = 25°C	0.2		mV	
			I _O = 1 mA, T _J = 25°C	3			
			I _O = 50 mA, T _J = 25°C	120	150		
			I _O = 50 mA	200			
			I _O = 75 mA, T _J = 25°C	180	225		
			I _O = 75 mA	300			
			I _O = 100 mA, T _J = 25°C	240	300		
			I _O = 100 mA	400			
			I _O = 150 mA, T _J = 25°C	360	450		
	I _O = 150 mA	600					
	Dropout voltage	TPS76333	TPS76333	I _O = 0 mA, T _J = 25°C	0.2		mV
				I _O = 1 mA, T _J = 25°C	3		
				I _O = 50 mA, T _J = 25°C	100	125	
				I _O = 50 mA	166		
				I _O = 75 mA, T _J = 25°C	150	188	
				I _O = 75 mA	250		
				I _O = 100 mA, T _J = 25°C	200	250	
				I _O = 100 mA	333		
				I _O = 150 mA, T _J = 25°C	300	375	
	I _O = 150 mA	500					
	Dropout voltage	TPS76350	TPS76350	I _O = 0 mA, T _J = 25°C	0.2		mV
				I _O = 1 mA, T _J = 25°C	2		
				I _O = 50 mA, T _J = 25°C	60	75	
				I _O = 50 mA	100		
				I _O = 75 mA, T _J = 25°C	90	113	
				I _O = 75 mA	150		
				I _O = 100 mA, T _J = 25°C	120	150	
I _O = 100 mA				200			
I _O = 150 mA, T _J = 25°C				180	225		
I _O = 150 mA	300						

TYPICAL CHARACTERISTICS



Figure 1

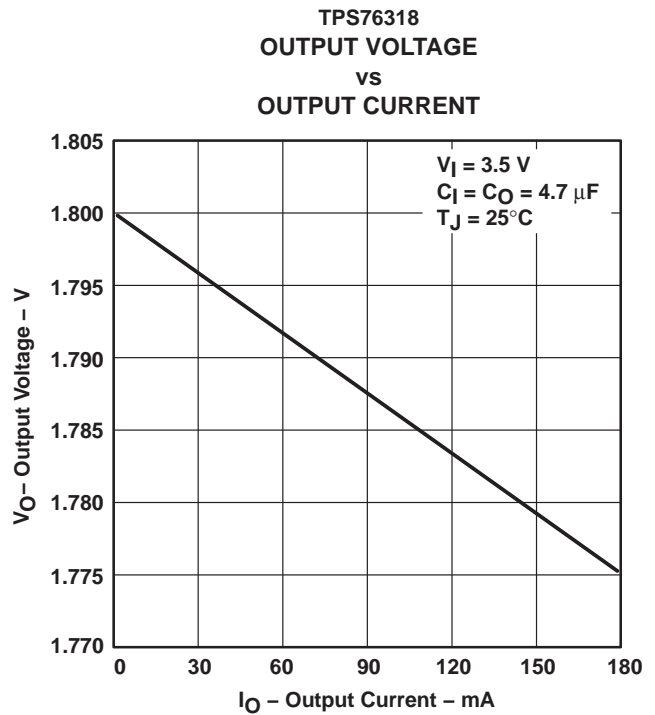

Figure 2



Figure 3

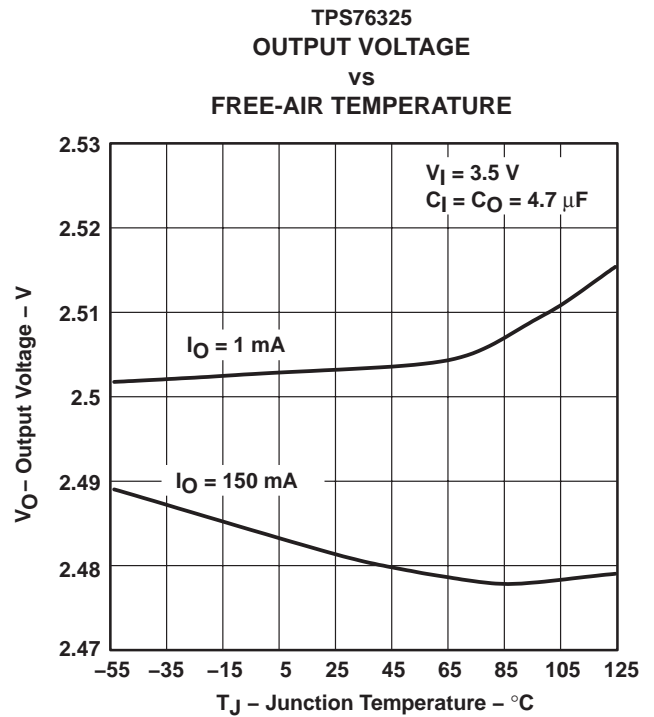
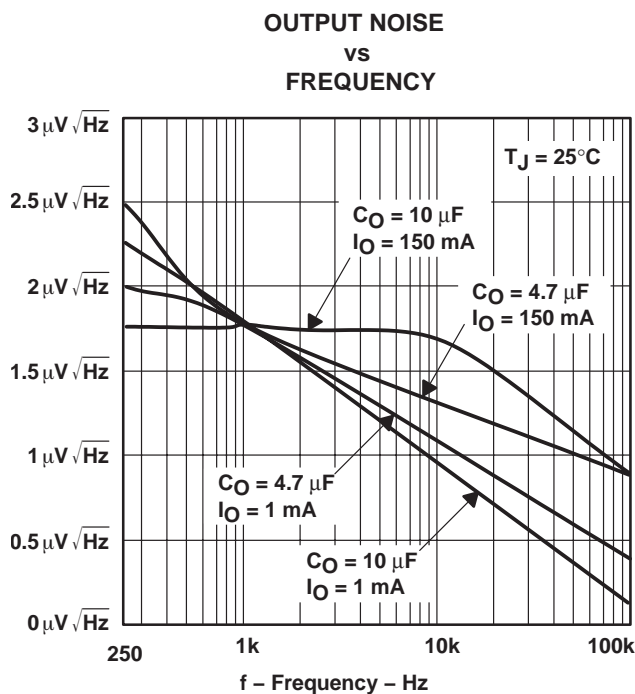
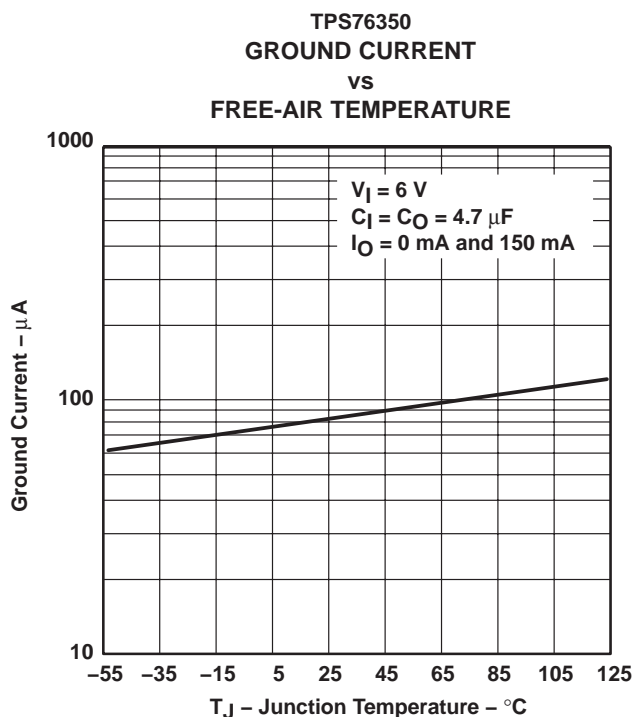
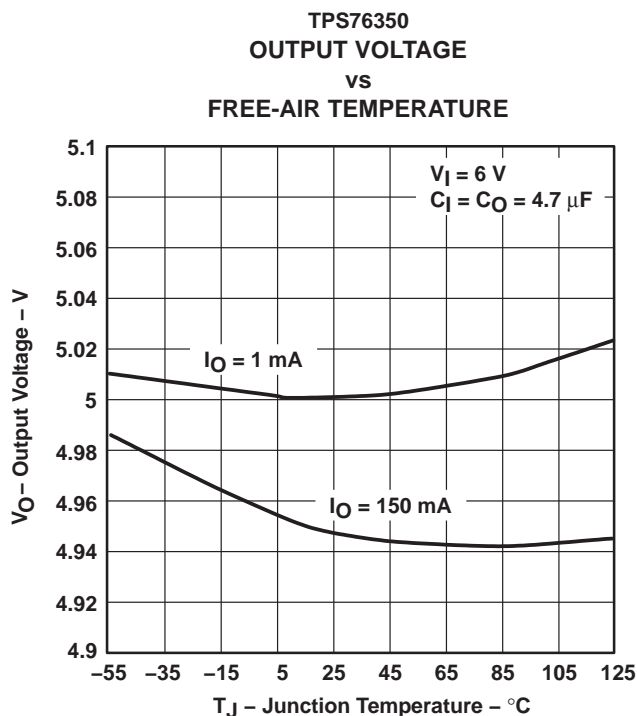
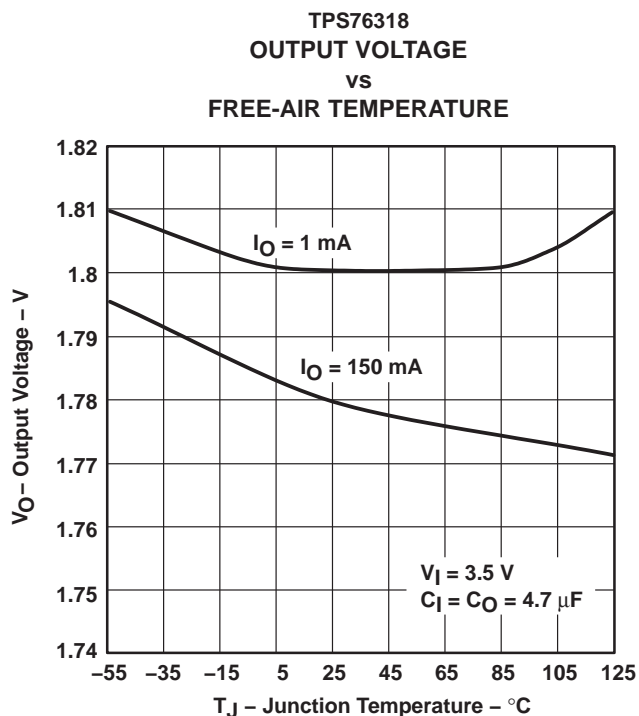

Figure 4

TYPICAL CHARACTERISTICS



TYPICAL CHARACTERISTICS

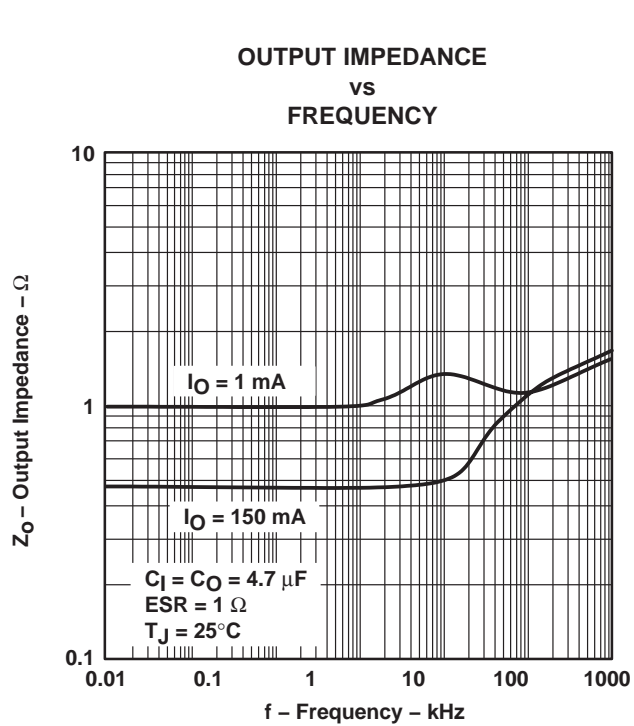

Figure 9

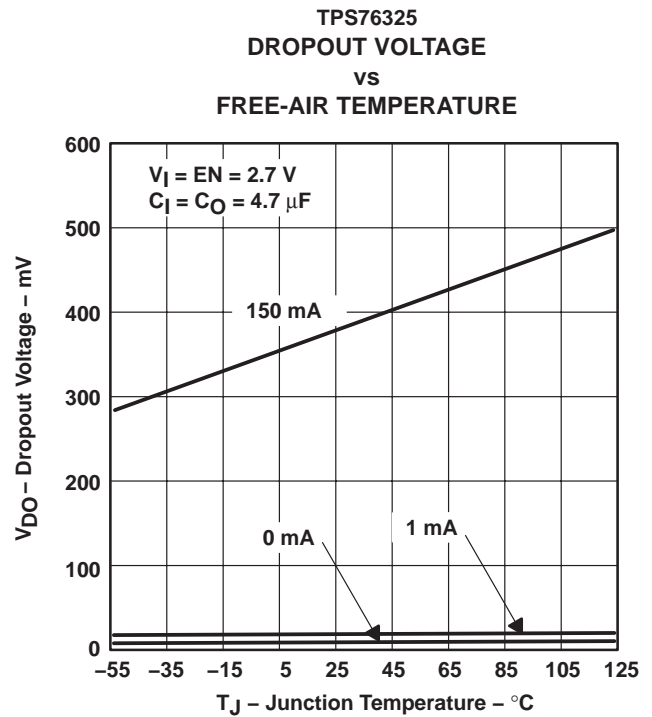

Figure 10



Figure 11

TYPICAL CHARACTERISTICS



Figure 12

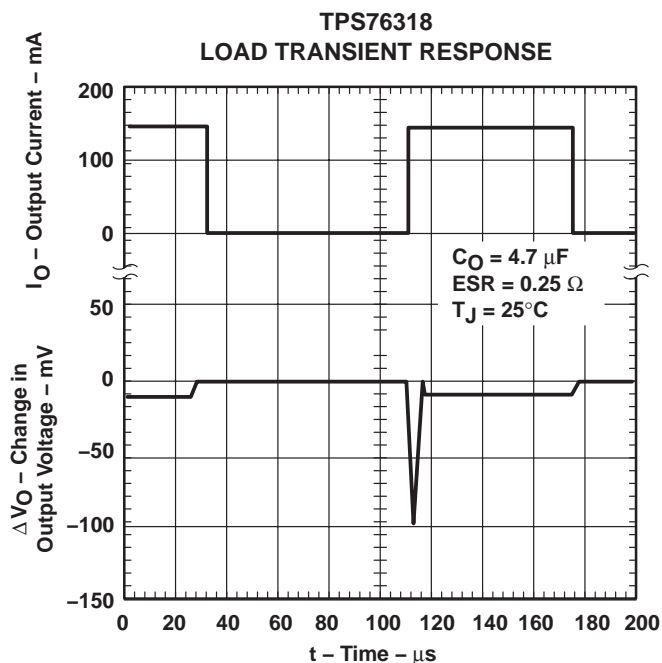

Figure 13



Figure 14

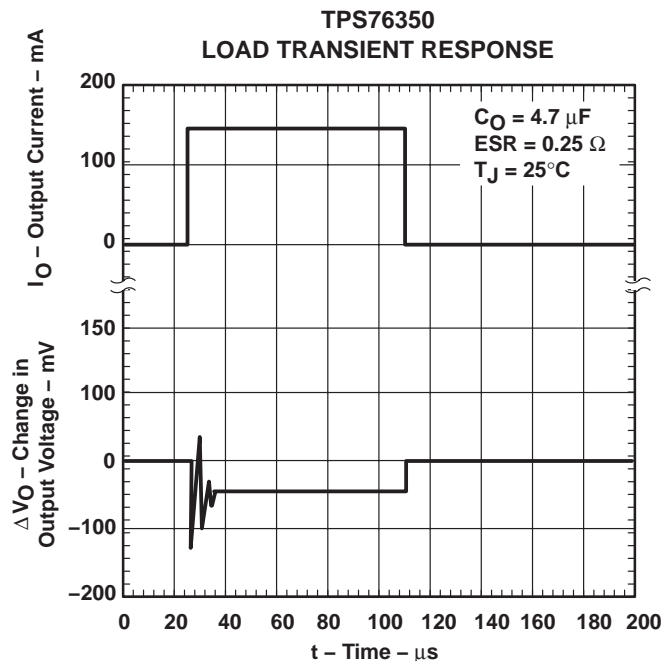

Figure 15

TYPICAL CHARACTERISTICS

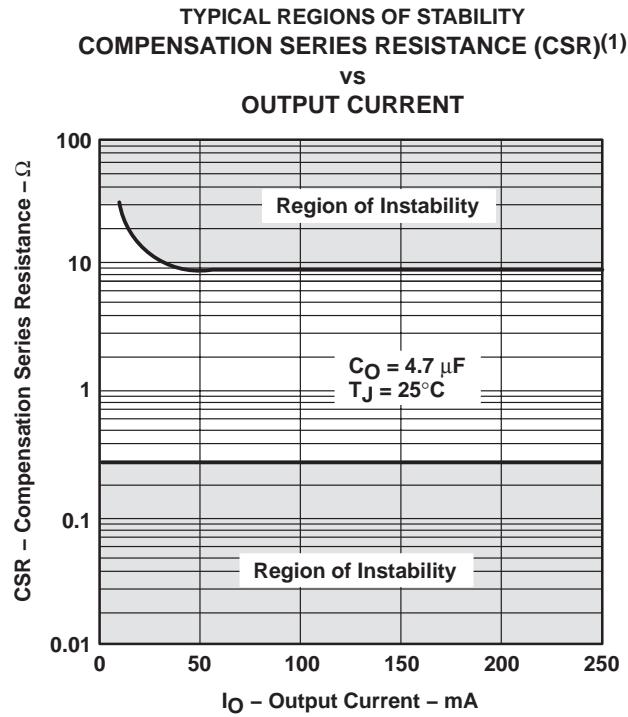

Figure 16

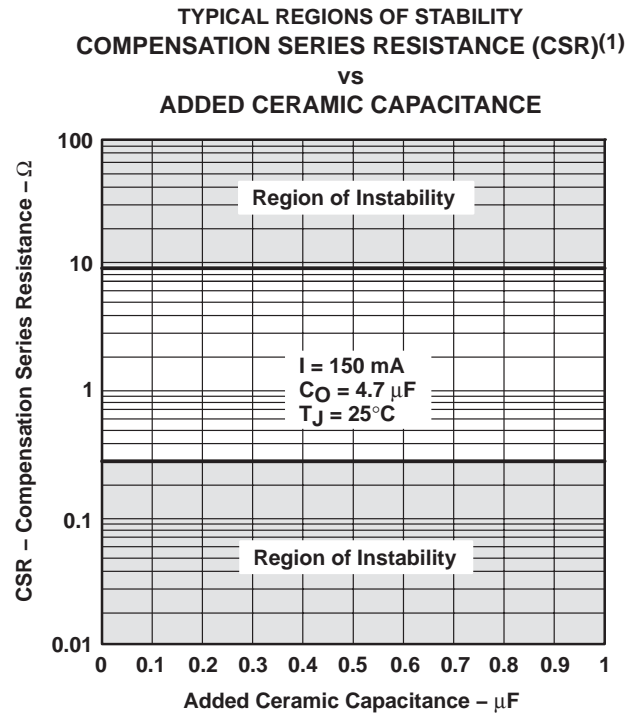

Figure 17

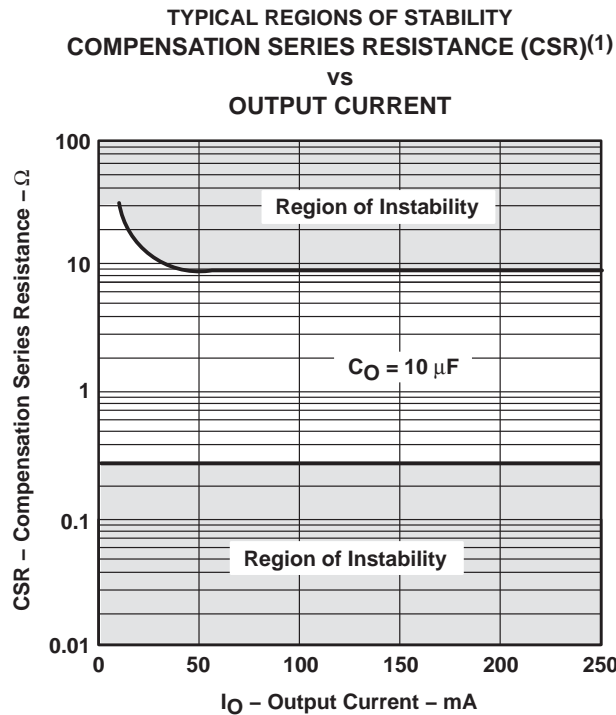

Figure 18

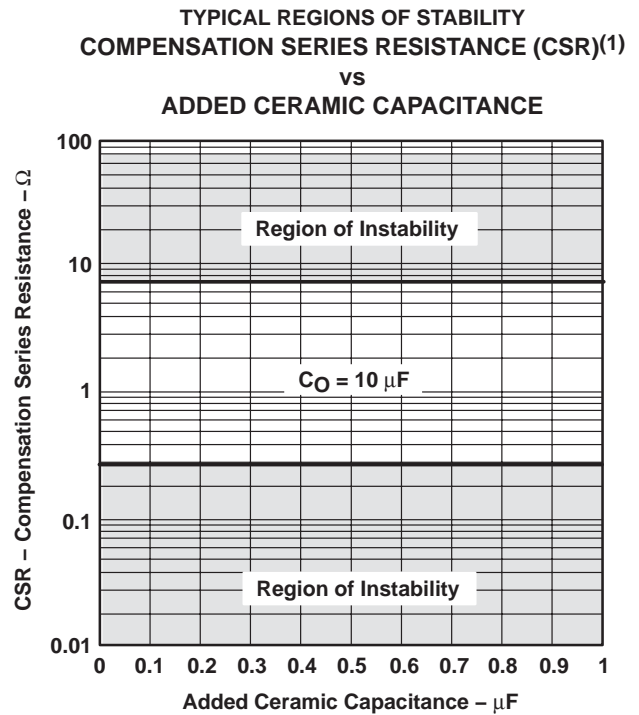

Figure 19

(1) CSR refers to the total series resistance, including the ESR of the capacitor, any series resistance added externally, and PWB trace resistance to C_O .

APPLICATION INFORMATION

The TPS763xx low-dropout (LDO) regulators are new families of regulators which have been optimized for use in battery-operated equipment and feature extremely low dropout voltages, low quiescent current (140 μ A), and an enable input to reduce supply currents to less than 2 μ A when the regulator is turned off.

device operation

The TPS763xx uses a PMOS pass element to dramatically reduce both dropout voltage and supply current over more conventional PNP pass element LDO designs. The PMOS pass element is a voltage-controlled device that, unlike a PNP transistor, does not require increased drive current as output current increases. Supply current in the TPS763xx is essentially constant from no-load to maximum load.

Current limiting and thermal protection prevent damage by excessive output current and/or power dissipation. The device switches into a constant-current mode at approximately 1 A; further load reduces the output voltage instead of increasing the output current. The thermal protection shuts the regulator off if the junction temperature rises above 165°C. Recovery is automatic when the junction temperature drops approximately 25°C below the high temperature trip point. The PMOS pass element includes a back diode that safely conducts reverse current when the input voltage level drops below the output voltage level.

A logic low on the enable input, EN shuts off the output and reduces the supply current to less than 2 μ A. EN should be tied high in applications where the shutdown feature is not used.

A typical application circuit is shown in Figure 20.



(1) TPS76316, TPS76318, TPS76325, TPS76327, TPS76328, TPS76330, TPS76333, TPS76338, TPS76350 (fixed-voltage options).

Figure 20. Typical Application Circuit

APPLICATION INFORMATION

external capacitor requirements

Although not required, a 0.047 μF or larger ceramic bypass input capacitor, connected between IN and GND and located close to the TPS763xx, is recommended to improve transient response and noise rejection. A higher-value electrolytic input capacitor may be necessary if large, fast-rise-time load transients are anticipated and the device is located several inches from the power source.

Like all low dropout regulators, the TPS763xx requires an output capacitor connected between OUT and GND to stabilize the internal loop control. The minimum recommended capacitance value is 4.7 μF and the ESR (equivalent series resistance) must be between 0.3 Ω and 10 Ω . Capacitor values 4.7 μF or larger are acceptable, provided the ESR is less than 10 Ω . Solid tantalum electrolytic, aluminum electrolytic, and multilayer ceramic capacitors are all suitable, provided they meet the requirements described above. Most of the commercially available 4.7 μF surface-mount solid tantalum capacitors, including devices from Sprague, Kemet, and Nichico, meet the ESR requirements stated above.

CAPACITOR SELECTION

PART NO.	MFR.	VALUE	MAX ESR ⁽¹⁾	SIZE (H \times L \times W) [†]
T494B475K016AS	KEMET	4.7 μF	1.5 Ω	1.9 \times 3.5 \times 2.8
195D106x0016x2T	SPRAGUE	10 μF	1.5 Ω	1.3 \times 7.0 \times 2.7
695D106x003562T	SPRAGUE	10 μF	1.3 Ω	2.5 \times 7.6 \times 2.5
TPSC475K035R0600	AVX	4.7 μF	0.6 Ω	2.6 \times 6.0 \times 3.2

(1) Size is in mm. ESR is maximum resistance in ohms at 100 kHz and $T_A = 25^\circ\text{C}$. Listings are sorted by height.

output voltage programming

The output voltage of the TPS76301 adjustable regulator is programmed using an external resistor divider as shown in Figure 21. The output voltage is calculated using:

$$V_O = 0.995 \times V_{\text{ref}} \times \left(1 + \frac{R1}{R2}\right) \quad (1)$$

Where:

$V_{\text{ref}} = 1.192 \text{ V typ}$ (the internal reference voltage)

0.995 is a constant used to center the load regulator (1%)

Resistors R1 and R2 should be chosen for approximately 7- μA divider current. Lower value resistors can be used but offer no inherent advantage and waste more power. Higher values should be avoided as leakage currents at FB increase the output voltage error. The recommended design procedure is to choose $R2 = 169 \text{ k}\Omega$ to set the divider current at 7 μA and then calculate R1 using:

$$R1 = \left(\frac{V_O}{0.995 \times V_{\text{ref}}} - 1 \right) \times R2 \quad (2)$$

APPLICATION INFORMATION



Figure 21. TPS76301 Adjustable LDO Regulator Programming

power dissipation and junction temperature

Specified regulator operation is assured to a junction temperature of 125°C; the maximum junction temperature allowable to avoid damaging the device is 150°C. This restriction limits the power dissipation the regulator can handle in any given application. To ensure the junction temperature is within acceptable limits, calculate the maximum allowable dissipation, $P_{D(max)}$, and the actual dissipation, P_D , which must be less than or equal to $P_{D(max)}$.

The maximum-power-dissipation limit is determined using the following equation:

$$P_{D(max)} = \frac{T_{Jmax} - T_A}{R_{\theta JA}}$$

Where:

T_{Jmax} is the maximum allowable junction temperature

$R_{\theta JA}$ is the thermal resistance junction-to-ambient for the package, see the dissipation rating table.

T_A is the ambient temperature.

The regulator dissipation is calculated using:

$$P_D = (V_I - V_O) \times I_O$$

Power dissipation resulting from quiescent current is negligible.

APPLICATION INFORMATION

regulator protection

The TPS763xx pass element has a built-in back diode that safely conducts reverse currents when the input voltage drops below the output voltage (e.g., during power down). Current is conducted from the output to the input and is not internally limited. If extended reverse voltage is anticipated, external limiting might be appropriate.

The TPS763xx also features internal current limiting and thermal protection. During normal operation, the TPS763xx limits output current to approximately 800 mA. When current limiting engages, the output voltage scales back linearly until the overcurrent condition ends. While current limiting is designed to prevent gross device failure, care should be taken not to exceed the power dissipation ratings of the package. If the temperature of the device exceeds 165°C, thermal-protection circuitry shuts it down. Once the device has cooled down to below 140°C, regulator operation resumes.

DBV (R-PDSO-G5)

PLASTIC SMALL-OUTLINE PACKAGE

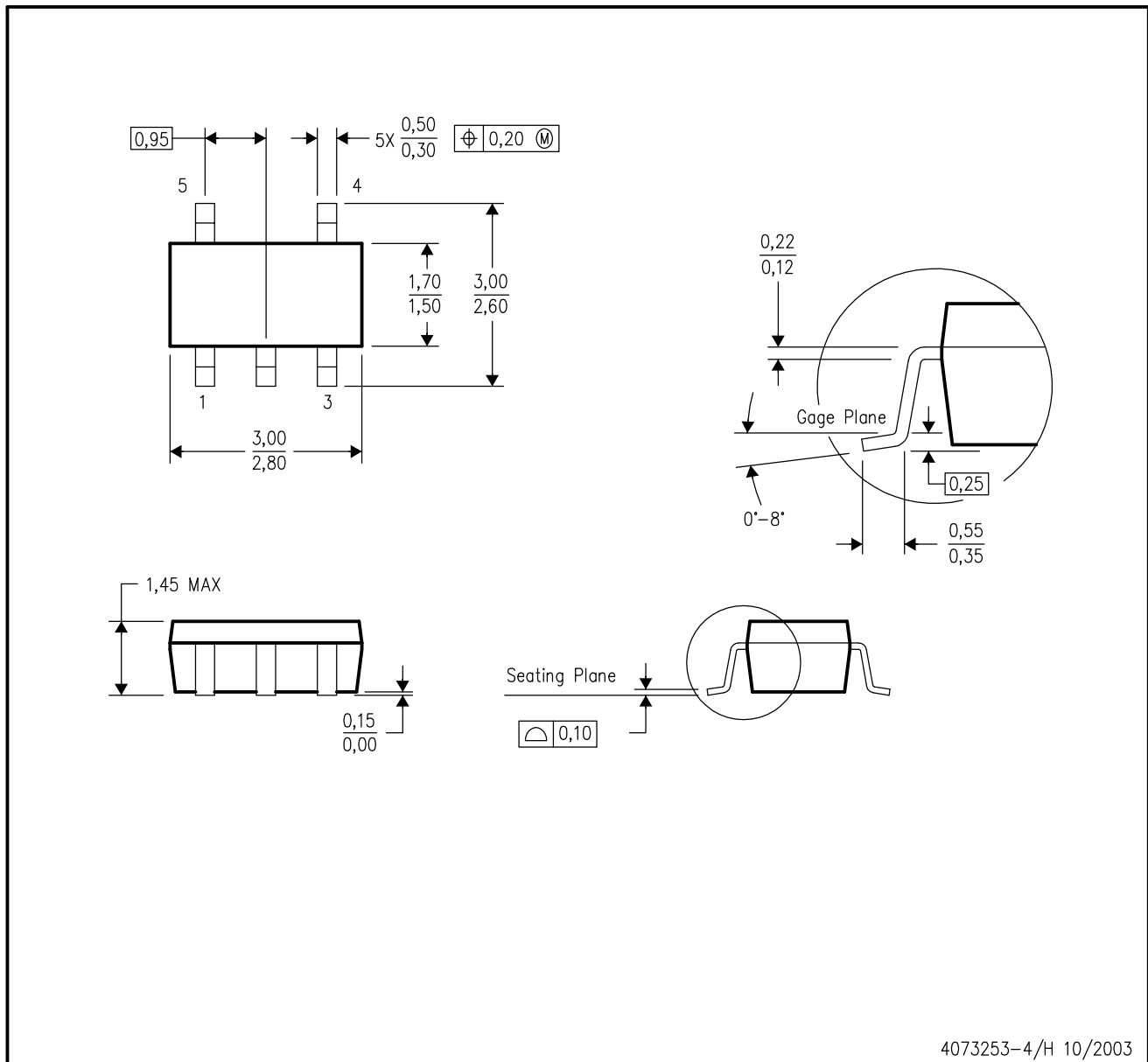

- NOTES:
- A. All linear dimensions are in millimeters.
 - B. This drawing is subject to change without notice.
 - C. Body dimensions do not include mold flash or protrusion.
 - D. Falls within JEDEC MO-178 Variation AA.

IMPORTANT NOTICE

Texas Instruments Incorporated and its subsidiaries (TI) reserve the right to make corrections, modifications, enhancements, improvements, and other changes to its products and services at any time and to discontinue any product or service without notice. Customers should obtain the latest relevant information before placing orders and should verify that such information is current and complete. All products are sold subject to TI's terms and conditions of sale supplied at the time of order acknowledgment.

TI warrants performance of its hardware products to the specifications applicable at the time of sale in accordance with TI's standard warranty. Testing and other quality control techniques are used to the extent TI deems necessary to support this warranty. Except where mandated by government requirements, testing of all parameters of each product is not necessarily performed.

TI assumes no liability for applications assistance or customer product design. Customers are responsible for their products and applications using TI components. To minimize the risks associated with customer products and applications, customers should provide adequate design and operating safeguards.

TI does not warrant or represent that any license, either express or implied, is granted under any TI patent right, copyright, mask work right, or other TI intellectual property right relating to any combination, machine, or process in which TI products or services are used. Information published by TI regarding third-party products or services does not constitute a license from TI to use such products or services or a warranty or endorsement thereof. Use of such information may require a license from a third party under the patents or other intellectual property of the third party, or a license from TI under the patents or other intellectual property of TI.

Reproduction of information in TI data books or data sheets is permissible only if reproduction is without alteration and is accompanied by all associated warranties, conditions, limitations, and notices. Reproduction of this information with alteration is an unfair and deceptive business practice. TI is not responsible or liable for such altered documentation.

Resale of TI products or services with statements different from or beyond the parameters stated by TI for that product or service voids all express and any implied warranties for the associated TI product or service and is an unfair and deceptive business practice. TI is not responsible or liable for any such statements.

Following are URLs where you can obtain information on other Texas Instruments products and application solutions:

Products		Applications	
Amplifiers	amplifier.ti.com	Audio	www.ti.com/audio
Data Converters	dataconverter.ti.com	Automotive	www.ti.com/automotive
DSP	dsp.ti.com	Broadband	www.ti.com/broadband
Interface	interface.ti.com	Digital Control	www.ti.com/digitalcontrol
Logic	logic.ti.com	Military	www.ti.com/military
Power Mgmt	power.ti.com	Optical Networking	www.ti.com/opticalnetwork
Microcontrollers	microcontroller.ti.com	Security	www.ti.com/security
		Telephony	www.ti.com/telephony
		Video & Imaging	www.ti.com/video
		Wireless	www.ti.com/wireless

Mailing Address: Texas Instruments
Post Office Box 655303 Dallas, Texas 75265