

TOSHIBA BIPOLAR LINEAR INTEGRATED CIRCUIT SILICON MONOLITHIC  
 TA78L005AP, TA78L006AP, TA78L007AP, TA78L075AP, TA78L008AP  
 TA78L009AP, TA78L010AP, TA78L012AP, TA78L132AP  
 TA78L015AP, TA78L018AP, TA78L020AP, TA78L024AP

**THREE TERMINAL POSITIVE REGULATORS**

**5 V, 6 V, 7 V, 7.5 V, 8 V, 9 V, 10 V, 12 V, 13.2 V, 15 V, 18 V, 20 V, 24 V**

**FEATURES**

- Suitable for TTL, C<sup>2</sup>MOS Power Supply
- Internal Short-Circuit Current Limiting
- Internal Thermal Overload Protection
- Maximum Output Current of 150 mA ( $T_j = 25^\circ\text{C}$ )
- Available in the Plastic TO-92MOD Package

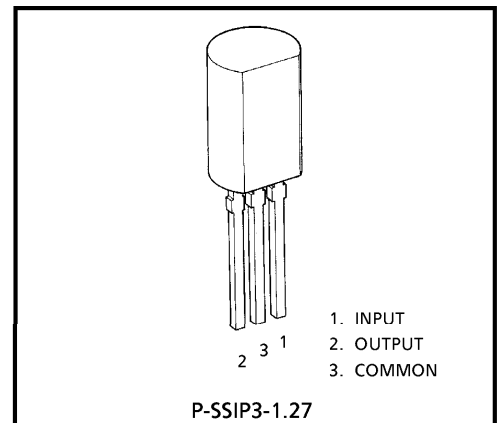

Weight : 0.36 g (Typ.)

**EQUIVALENT CIRCUIT**

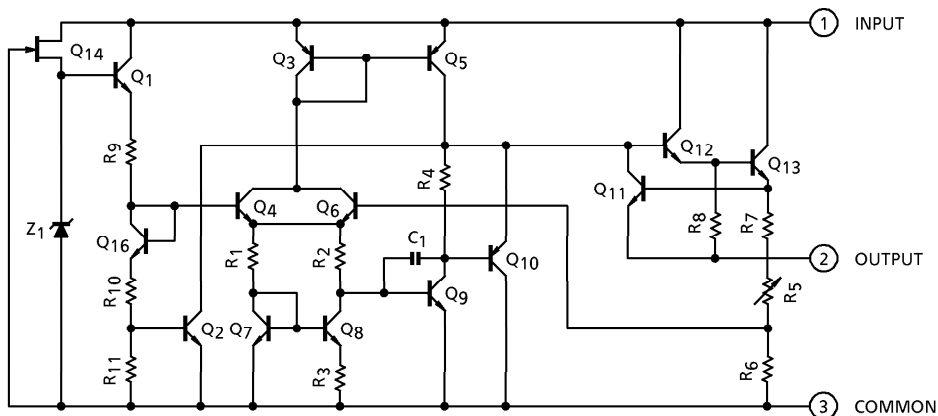

980910EBA1

- TOSHIBA is continually working to improve the quality and the reliability of its products. Nevertheless, semiconductor devices in general can malfunction or fail due to their inherent electrical sensitivity and vulnerability to physical stress. It is the responsibility of the buyer, when utilizing TOSHIBA products, to observe standards of safety, and to avoid situations in which a malfunction or failure of a TOSHIBA product could cause loss of human life, bodily injury or damage to property. In developing your designs, please ensure that TOSHIBA products are used within specified operating ranges as set forth in the most recent products specifications. Also, please keep in mind the precautions and conditions set forth in the TOSHIBA Semiconductor Reliability Handbook.
- The products described in this document are subject to the foreign exchange and foreign trade laws.
- The information contained herein is presented only as a guide for the applications of our products. No responsibility is assumed by TOSHIBA CORPORATION for any infringements of intellectual property or other rights of the third parties which may result from its use. No license is granted by implication or otherwise under any intellectual property or other rights of TOSHIBA CORPORATION or others.
- The information contained herein is subject to change without notice.

**MAXIMUM RATINGS (Ta = 25°C)**

CHARACTERISTIC		SYMBOL	RATING	UNIT
Input Voltage	TA78L005AP	V <sub>IN</sub>	35	V
	TA78L006AP			
	TA78L007AP			
	TA78L075AP			
	TA78L008AP			
	TA78L009AP			
	TA78L010AP			
	TA78L012AP			
	TA78L132AP			
	TA78L015AP			
	TA78L018AP		40	
	TA78L020AP			
	TA78L024AP			
Power Dissipation	(Ta = 25°C)	P <sub>D</sub>	800	mW
Operating Temperature		T <sub>opr</sub>	- 30~85	°C
Storage Temperature		T <sub>stg</sub>	- 55~150	°C
Junction Temperature		T <sub>j</sub>	150	°C
Thermal Resistance		R <sub>th(j-a)</sub>	156	°C/W

TA78L005AP

**ELECTRICAL CHARACTERISTICS**

(Unless otherwise specified,  $V_{IN} = 10\text{ V}$ ,  $I_{OUT} = 40\text{ mA}$ ,  $C_{IN} = 0.33\ \mu\text{F}$ ,  $C_{OUT} = 0.1\ \mu\text{F}$ ,  $0^\circ\text{C} \leq T_j \leq 125^\circ\text{C}$ )

CHARACTERISTIC	SYMBOL	TEST CIR-CUIT	TEST CONDITION	MIN.	TYP.	MAX.	UNIT	
Output Voltage	$V_{OUT}$	1	$T_j = 25^\circ\text{C}$	4.8	5.0	5.2	V	
Line Regulation	Reg·line	1	$T_j = 25^\circ\text{C}$	$7.0\text{ V} \leq V_{IN} \leq 20\text{ V}$	—	55	150	mV
				$8.0\text{ V} \leq V_{IN} \leq 20\text{ V}$	—	45	100	
Load Regulation	Reg·load	1	$T_j = 25^\circ\text{C}$	$1.0\text{ mA} \leq I_{OUT} \leq 100\text{ mA}$	—	11	60	mV
				$1.0\text{ mA} \leq I_{OUT} \leq 40\text{ mA}$	—	5.0	30	
Output Voltage	$V_{OUT}$	1	$T_j = 25^\circ\text{C}$	$7.0\text{ V} \leq V_{IN} \leq 20\text{ V}$ , $1.0\text{ mA} \leq I_{OUT} \leq 40\text{ mA}$	4.75	—	5.25	V
				$1.0\text{ mA} \leq I_{OUT} \leq 70\text{ mA}$	4.75	—	5.25	
Quiescent Current	$I_B$	1	$T_j = 25^\circ\text{C}$	—	3.1	6.0	mA	
			$T_j = 125^\circ\text{C}$	—	—	5.5		
Quiescent Current Change	$\Delta I_B$	1	$T_j = 25^\circ\text{C}$	$8.0\text{ V} \leq V_{IN} \leq 20\text{ V}$	—	—	1.5	mA
				$1.0\text{ mA} \leq I_{OUT} \leq 40\text{ mA}$	—	—	0.1	
Output Noise Voltage	$V_{NO}$	2	$T_a = 25^\circ\text{C}$ , $10\text{ Hz} \leq f \leq 100\text{ kHz}$	—	40	—	$\mu\text{V}_{rms}$	
Long Term Stability	$\Delta V_{OUT} / \Delta t$	1	—	—	12	—	mV/kh	
Ripple Rejection	R.R.	3	$f = 120\text{ Hz}$ , $8.0\text{ V} \leq V_{IN} \leq 18\text{ V}$ , $T_j = 25^\circ\text{C}$	41	49	—	dB	
Dropout Voltage	$V_D$	1	$T_j = 25^\circ\text{C}$ , $I_{OUT} = 150\text{ mA}$	—	1.7	—	V	
Average Temperature Coefficient of Output Voltage	$T_{CVO}$	1	$I_{OUT} = 5\text{ mA}$	—	-0.6	—	mV/ $^\circ\text{C}$	

TA78L006AP

**ELECTRICAL CHARACTERISTICS**

(Unless otherwise specified,  $V_{IN} = 11\text{ V}$ ,  $I_{OUT} = 40\text{ mA}$ ,  $C_{IN} = 0.33\ \mu\text{F}$ ,  $C_{OUT} = 0.1\ \mu\text{F}$ ,  $0^\circ\text{C} \leq T_j \leq 125^\circ\text{C}$ )

CHARACTERISTIC	SYMBOL	TEST CIR-CUIT	TEST CONDITION	MIN.	TYP.	MAX.	UNIT	
Output Voltage	$V_{OUT}$	1	$T_j = 25^\circ\text{C}$	5.76	6.0	6.24	V	
Line Regulation	Reg·line	1	$T_j = 25^\circ\text{C}$	$8.1\text{ V} \leq V_{IN} \leq 21\text{ V}$	—	50	150	mV
				$9.0\text{ V} \leq V_{IN} \leq 21\text{ V}$	—	45	110	
Load Regulation	Reg·load	1	$T_j = 25^\circ\text{C}$	$1.0\text{ mA} \leq I_{OUT} \leq 100\text{ mA}$	—	12	70	mV
				$1.0\text{ mA} \leq I_{OUT} \leq 40\text{ mA}$	—	5.5	35	
Output Voltage	$V_{OUT}$	1	$T_j = 25^\circ\text{C}$	$8.1\text{ V} \leq V_{IN} \leq 21\text{ V}$	5.7	—	6.3	V
				$1.0\text{ mA} \leq I_{OUT} \leq 40\text{ mA}$	5.7	—	6.3	
				$1.0\text{ mA} \leq I_{OUT} \leq 70\text{ mA}$	5.7	—	6.3	
Quiescent Current	$I_B$	1	$T_j = 25^\circ\text{C}$	—	3.1	6.0	mA	
			$T_j = 125^\circ\text{C}$	—	—	5.5		
Quiescent Current Change	$\Delta I_B$	1	$T_j = 25^\circ\text{C}$	$9.0\text{ V} \leq V_{IN} \leq 20\text{ V}$	—	—	1.5	mA
				$1.0\text{ mA} \leq I_{OUT} \leq 40\text{ mA}$	—	—	0.1	
Output Noise Voltage	$V_{NO}$	2	$T_a = 25^\circ\text{C}$ , $10\text{ Hz} \leq f \leq 100\text{ kHz}$	—	40	—	$\mu\text{V}_{rms}$	
Long Term Stability	$\Delta V_{OUT} / \Delta t$	1	—	—	14	—	mV/kh	
Ripple Rejection	R.R.	3	$f = 120\text{ Hz}$ , $9.0\text{ V} \leq V_{IN} \leq 19\text{ V}$ , $T_j = 25^\circ\text{C}$	39	47	—	dB	
Dropout Voltage	$V_D$	1	$T_j = 25^\circ\text{C}$ , $I_{OUT} = 150\text{ mA}$	—	1.7	—	V	
Average Temperature Coefficient of Output Voltage	$T_{CVO}$	1	$I_{OUT} = 5\text{ mA}$	—	-0.7	—	mV/°C	

TA78L007AP

**ELECTRICAL CHARACTERISTICS**

(Unless otherwise specified,  $V_{IN} = 12\text{ V}$ ,  $I_{OUT} = 40\text{ mA}$ ,  $C_{IN} = 0.33\ \mu\text{F}$ ,  $C_{OUT} = 0.1\ \mu\text{F}$ ,  $0^\circ\text{C} \leq T_j \leq 125^\circ\text{C}$ )

CHARACTERISTIC	SYMBOL	TEST CIR-CUIT	TEST CONDITION	MIN.	TYP.	MAX.	UNIT	
Output Voltage	$V_{OUT}$	1	$T_j = 25^\circ\text{C}$	6.72	7.0	7.28	V	
Line Regulation	Reg·line	1	$T_j = 25^\circ\text{C}$	$9.2\text{ V} \leq V_{IN} \leq 22\text{ V}$	—	50	160	mV
				$10\text{ V} \leq V_{IN} \leq 22\text{ V}$	—	45	115	
Load Regulation	Reg·load	1	$T_j = 25^\circ\text{C}$	$1.0\text{ mA} \leq I_{OUT} \leq 100\text{ mA}$	—	13	75	mV
				$1.0\text{ mA} \leq I_{OUT} \leq 40\text{ mA}$	—	6.0	40	
Output Voltage	$V_{OUT}$	1	$T_j = 25^\circ\text{C}$	$9.2\text{ V} \leq V_{IN} \leq 22\text{ V}$	6.65	—	7.35	V
				$1.0\text{ mA} \leq I_{OUT} \leq 40\text{ mA}$	6.65	—	7.35	
				$1.0\text{ mA} \leq I_{OUT} \leq 70\text{ mA}$	6.65	—	7.35	
Quiescent Current	$I_B$	1	$T_j = 25^\circ\text{C}$	—	3.1	6.5	mA	
			$T_j = 125^\circ\text{C}$	—	—	6.0		
Quiescent Current Change	$\Delta I_B$	1	$T_j = 25^\circ\text{C}$	$10\text{ V} \leq V_{IN} \leq 22\text{ V}$	—	—	1.5	mA
				$1.0\text{ mA} \leq I_{OUT} \leq 40\text{ mA}$	—	—	0.1	
Output Noise Voltage	$V_{NO}$	2	$T_a = 25^\circ\text{C}$ , $10\text{ Hz} \leq f \leq 100\text{ kHz}$	—	50	—	$\mu\text{V}_{rms}$	
Long Term Stability	$\Delta V_{OUT} / \Delta t$	1	—	—	17	—	mV/kh	
Ripple Rejection	R.R.	3	$f = 120\text{ Hz}$ , $10\text{ V} \leq V_{IN} \leq 20\text{ V}$ , $T_j = 25^\circ\text{C}$	37	46	—	dB	
Dropout Voltage	$V_D$	1	$T_j = 25^\circ\text{C}$ , $I_{OUT} = 150\text{ mA}$	—	1.7	—	V	
Average Temperature Coefficient of Output Voltage	$T_{CVO}$	1	$I_{OUT} = 5\text{ mA}$	—	-0.75	—	mV/°C	

TA78L075AP

**ELECTRICAL CHARACTERISTICS**

(Unless otherwise specified,  $V_{IN} = 13\text{ V}$ ,  $I_{OUT} = 40\text{ mA}$ ,  $C_{IN} = 0.33\ \mu\text{F}$ ,  $C_{OUT} = 0.1\ \mu\text{F}$ ,  $0^\circ\text{C} \leq T_j \leq 125^\circ\text{C}$ )

CHARACTERISTIC	SYMBOL	TEST CIR-CUIT	TEST CONDITION	MIN.	TYP.	MAX.	UNIT	
Output Voltage	$V_{OUT}$	1	$T_j = 25^\circ\text{C}$	7.21	7.5	7.79	V	
Line Regulation	Reg·line	1	$T_j = 25^\circ\text{C}$	$9.8\text{ V} \leq V_{IN} \leq 23\text{ V}$	—	40	170	mV
				$10.5\text{ V} \leq V_{IN} \leq 23\text{ V}$	—	40	120	
Load Regulation	Reg·load	1	$T_j = 25^\circ\text{C}$	$1.0\text{ mA} \leq I_{OUT} \leq 100\text{ mA}$	—	14	80	mV
				$1.0\text{ mA} \leq I_{OUT} \leq 40\text{ mA}$	—	6.5	40	
Output Voltage	$V_{OUT}$	1	$T_j = 25^\circ\text{C}$	$9.8\text{ V} \leq V_{IN} \leq 23\text{ V}$ , $1.0\text{ mA} \leq I_{OUT} \leq 40\text{ mA}$	7.125	—	7.875	V
				$1.0\text{ mA} \leq I_{OUT} \leq 70\text{ mA}$	7.125	—	7.875	
Quiescent Current	$I_B$	1	$T_j = 25^\circ\text{C}$	—	3.1	6.5	mA	
			$T_j = 125^\circ\text{C}$	—	—	6.0		
Quiescent Current Change	$\Delta I_B$	1	$T_j = 25^\circ\text{C}$	$10.5\text{ V} \leq V_{IN} \leq 23\text{ V}$	—	—	1.5	mA
				$1.0\text{ mA} \leq I_{OUT} \leq 40\text{ mA}$	—	—	0.1	
Output Noise Voltage	$V_{NO}$	2	$T_a = 25^\circ\text{C}$ , $10\text{ Hz} \leq f \leq 100\text{ kHz}$	—	60	—	$\mu\text{V}_{rms}$	
Long Term Stability	$\Delta V_{OUT} / \Delta t$	1	—	—	19	—	mV/kh	
Ripple Rejection	R.R.	3	$f = 120\text{ Hz}$ , $11\text{ V} \leq V_{IN} \leq 21\text{ V}$ , $T_j = 25^\circ\text{C}$	37	45	—	dB	
Dropout Voltage	$V_D$	1	$T_j = 25^\circ\text{C}$ , $I_{OUT} = 150\text{ mA}$	—	1.7	—	V	
Average Temperature Coefficient of Output Voltage	$T_{CVO}$	1	$I_{OUT} = 5\text{ mA}$	—	-0.75	—	mV/°C	

TA78L008AP

**ELECTRICAL CHARACTERISTICS**

(Unless otherwise specified,  $V_{IN} = 14\text{ V}$ ,  $I_{OUT} = 40\text{ mA}$ ,  $C_{IN} = 0.33\text{ }\mu\text{F}$ ,  $C_{OUT} = 0.1\text{ }\mu\text{F}$ ,  $0^\circ\text{C} \leq T_j \leq 125^\circ\text{C}$ )

CHARACTERISTIC	SYMBOL	TEST CIR-CUIT	TEST CONDITION	MIN.	TYP.	MAX.	UNIT	
Output Voltage	$V_{OUT}$	1	$T_j = 25^\circ\text{C}$	7.7	8.0	8.3	V	
Line Regulation	Reg·line	1	$T_j = 25^\circ\text{C}$	$10.5\text{ V} \leq V_{IN} \leq 23\text{ V}$	—	20	175	mV
				$11\text{ V} \leq V_{IN} \leq 23\text{ V}$	—	12	125	
Load Regulation	Reg·load	1	$T_j = 25^\circ\text{C}$	$1.0\text{ mA} \leq I_{OUT} \leq 100\text{ mA}$	—	15	80	mV
				$1.0\text{ mA} \leq I_{OUT} \leq 40\text{ mA}$	—	7.0	40	
Output Voltage	$V_{OUT}$	1	$T_j = 25^\circ\text{C}$	$10.5\text{ V} \leq V_{IN} \leq 23\text{ V}$ , $1.0\text{ mA} \leq I_{OUT} \leq 40\text{ mA}$	7.6	—	8.4	V
				$1.0\text{ mA} \leq I_{OUT} \leq 70\text{ mA}$	7.6	—	8.4	
Quiescent Current	$I_B$	1	$T_j = 25^\circ\text{C}$	—	3.1	6.5	mA	
			$T_j = 125^\circ\text{C}$	—	—	6.0		
Quiescent Current Change	$\Delta I_B$	1	$T_j = 25^\circ\text{C}$	$11\text{ V} \leq V_{IN} \leq 23\text{ V}$	—	—	1.5	mA
				$1.0\text{ mA} \leq I_{OUT} \leq 40\text{ mA}$	—	—	0.1	
Output Noise Voltage	$V_{NO}$	2	$T_a = 25^\circ\text{C}$ , $10\text{ Hz} \leq f \leq 100\text{ kHz}$	—	60	—	$\mu\text{V}_{rms}$	
Long Term Stability	$\Delta V_{OUT} / \Delta t$	1	—	—	20	—	mV/kh	
Ripple Rejection	R.R.	3	$f = 120\text{ Hz}$ , $12\text{ V} \leq V_{IN} \leq 23\text{ V}$ , $T_j = 25^\circ\text{C}$	37	45	—	dB	
Dropout Voltage	$V_D$	1	$T_j = 25^\circ\text{C}$ , $I_{OUT} = 150\text{ mA}$	—	1.7	—	V	
Average Temperature Coefficient of Output Voltage	$T_{CVO}$	1	$I_{OUT} = 5\text{ mA}$	—	-0.8	—	mV/ $^\circ\text{C}$	

TA78L009AP

**ELECTRICAL CHARACTERISTICS**

(Unless otherwise specified,  $V_{IN} = 15\text{ V}$ ,  $I_{OUT} = 40\text{ mA}$ ,  $C_{IN} = 0.33\ \mu\text{F}$ ,  $C_{OUT} = 0.1\ \mu\text{F}$ ,  $0^\circ\text{C} \leq T_j \leq 125^\circ\text{C}$ )

CHARACTERISTIC	SYMBOL	TEST CIR-CUIT	TEST CONDITION	MIN.	TYP.	MAX.	UNIT	
Output Voltage	$V_{OUT}$	1	$T_j = 25^\circ\text{C}$	8.64	9.0	9.36	V	
Line Regulation	Reg·line	1	$T_j = 25^\circ\text{C}$	$11.4\text{ V} \leq V_{IN} \leq 24\text{ V}$	—	80	200	mV
				$12\text{ V} \leq V_{IN} \leq 24\text{ V}$	—	20	160	
Load Regulation	Reg·load	1	$T_j = 25^\circ\text{C}$	$1.0\text{ mA} \leq I_{OUT} \leq 100\text{ mA}$	—	17	90	mV
				$1.0\text{ mA} \leq I_{OUT} \leq 40\text{ mA}$	—	8.0	45	
Output Voltage	$V_{OUT}$	1	$T_j = 25^\circ\text{C}$	$11.4\text{ V} \leq V_{IN} \leq 24\text{ V}$ , $1.0\text{ mA} \leq I_{OUT} \leq 40\text{ mA}$	8.55	—	9.45	V
				$1.0\text{ mA} \leq I_{OUT} \leq 70\text{ mA}$	8.55	—	9.45	
Quiescent Current	$I_B$	1	$T_j = 25^\circ\text{C}$	—	3.2	6.5	mA	
			$T_j = 125^\circ\text{C}$	—	—	6.0		
Quiescent Current Change	$\Delta I_B$	1	$T_j = 25^\circ\text{C}$	$12\text{ V} \leq V_{IN} \leq 24\text{ V}$	—	—	1.5	mA
				$1.0\text{ mA} \leq I_{OUT} \leq 40\text{ mA}$	—	—	0.1	
Output Noise Voltage	$V_{NO}$	2	$T_a = 25^\circ\text{C}$ , $10\text{ Hz} \leq f \leq 100\text{ kHz}$	—	65	—	$\mu\text{V}_{rms}$	
Long Term Stability	$\Delta V_{OUT} / \Delta t$	1	—	—	21	—	mV/kh	
Ripple Rejection	R.R.	3	$f = 120\text{ Hz}$ , $12\text{ V} \leq V_{IN} \leq 24\text{ V}$ , $T_j = 25^\circ\text{C}$	36	44	—	dB	
Dropout Voltage	$V_D$	1	$T_j = 25^\circ\text{C}$ , $I_{OUT} = 150\text{ mA}$	—	1.7	—	V	
Average Temperature Coefficient of Output Voltage	$T_{CVO}$	1	$I_{OUT} = 5\text{ mA}$	—	-0.85	—	mV/°C	



TA78L010AP

**ELECTRICAL CHARACTERISTICS**

(Unless otherwise specified,  $V_{IN} = 16\text{ V}$ ,  $I_{OUT} = 40\text{ mA}$ ,  $C_{IN} = 0.33\ \mu\text{F}$ ,  $C_{OUT} = 0.1\ \mu\text{F}$ ,  $0^\circ\text{C} \leq T_j \leq 125^\circ\text{C}$ )

CHARACTERISTIC	SYMBOL	TEST CIR-CUIT	TEST CONDITION	MIN.	TYP.	MAX.	UNIT	
Output Voltage	$V_{OUT}$	1	$T_j = 25^\circ\text{C}$	9.6	10	10.4	V	
Line Regulation	Reg·line	1	$T_j = 25^\circ\text{C}$	$12.5\text{ V} \leq V_{IN} \leq 25\text{ V}$	—	80	230	mV
				$13\text{ V} \leq V_{IN} \leq 25\text{ V}$	—	30	170	
Load Regulation	Reg·load	1	$T_j = 25^\circ\text{C}$	$1.0\text{ mA} \leq I_{OUT} \leq 100\text{ mA}$	—	18	90	mV
				$1.0\text{ mA} \leq I_{OUT} \leq 40\text{ mA}$	—	8.5	45	
Output Voltage	$V_{OUT}$	1	$T_j = 25^\circ\text{C}$	$12.5\text{ V} \leq V_{IN} \leq 25\text{ V}$ , $1.0\text{ mA} \leq I_{OUT} \leq 40\text{ mA}$	9.5	—	10.5	V
				$1.0\text{ mA} \leq I_{OUT} \leq 70\text{ mA}$	9.5	—	10.5	
Quiescent Current	$I_B$	1	$T_j = 25^\circ\text{C}$	—	3.2	6.5	mA	
			$T_j = 125^\circ\text{C}$	—	—	6.0		
Quiescent Current Change	$\Delta I_B$	1	$T_j = 25^\circ\text{C}$	$13\text{ V} \leq V_{IN} \leq 25\text{ V}$	—	—	1.5	mA
				$1.0\text{ mA} \leq I_{OUT} \leq 40\text{ mA}$	—	—	0.1	
Output Noise Voltage	$V_{NO}$	2	$T_a = 25^\circ\text{C}$ , $10\text{ Hz} \leq f \leq 100\text{ kHz}$	—	70	—	$\mu\text{V}_{rms}$	
Long Term Stability	$\Delta V_{OUT} / \Delta t$	1	—	—	22	—	mV/kh	
Ripple Rejection	R.R.	3	$f = 120\text{ Hz}$ , $13\text{ V} \leq V_{IN} \leq 24\text{ V}$ , $T_j = 25^\circ\text{C}$	36	43	—	dB	
Dropout Voltage	$V_D$	1	$T_j = 25^\circ\text{C}$ , $I_{OUT} = 150\text{ mA}$	—	1.7	—	V	
Average Temperature Coefficient of Output Voltage	$T_{CVO}$	1	$I_{OUT} = 5\text{ mA}$	—	-0.9	—	mV/ $^\circ\text{C}$	

TA78L012AP

**ELECTRICAL CHARACTERISTICS**

(Unless otherwise specified,  $V_{IN} = 19\text{ V}$ ,  $I_{OUT} = 40\text{ mA}$ ,  $C_{IN} = 0.33\ \mu\text{F}$ ,  $C_{OUT} = 0.1\ \mu\text{F}$ ,  $0^\circ\text{C} \leq T_j \leq 125^\circ\text{C}$ )

CHARACTERISTIC	SYMBOL	TEST CIR-CUIT	TEST CONDITION	MIN.	TYP.	MAX.	UNIT	
Output Voltage	$V_{OUT}$	1	$T_j = 25^\circ\text{C}$	11.5	12	12.5	V	
Line Regulation	Reg·line	1	$T_j = 25^\circ\text{C}$	$14.5\text{ V} \leq V_{IN} \leq 27\text{ V}$	—	120	250	mV
				$16\text{ V} \leq V_{IN} \leq 27\text{ V}$	—	100	200	
Load Regulation	Reg·load	1	$T_j = 25^\circ\text{C}$	$1.0\text{ mA} \leq I_{OUT} \leq 100\text{ mA}$	—	20	100	mV
				$1.0\text{ mA} \leq I_{OUT} \leq 40\text{ mA}$	—	10	50	
Output Voltage	$V_{OUT}$	1	$T_j = 25^\circ\text{C}$	$14.5\text{ V} \leq V_{IN} \leq 27\text{ V}$ , $1.0\text{ mA} \leq I_{OUT} \leq 40\text{ mA}$	11.4	—	12.6	V
				$1.0\text{ mA} \leq I_{OUT} \leq 70\text{ mA}$	11.4	—	12.6	
Quiescent Current	$I_B$	1	$T_j = 25^\circ\text{C}$	—	3.2	6.5	mA	
			$T_j = 125^\circ\text{C}$	—	—	6.0		
Quiescent Current Change	$\Delta I_B$	1	$T_j = 25^\circ\text{C}$	$16\text{ V} \leq V_{IN} \leq 27\text{ V}$	—	—	1.5	mA
				$1.0\text{ mA} \leq I_{OUT} \leq 40\text{ mA}$	—	—	0.1	
Output Noise Voltage	$V_{NO}$	2	$T_a = 25^\circ\text{C}$ , $10\text{ Hz} \leq f \leq 100\text{ kHz}$	—	80	—	$\mu\text{V}_{rms}$	
Long Term Stability	$\Delta V_{OUT} / \Delta t$	1	—	—	24	—	mV/kh	
Ripple Rejection	R.R.	3	$f = 120\text{ Hz}$ , $15\text{ V} \leq V_{IN} \leq 25\text{ V}$ , $T_j = 25^\circ\text{C}$	36	41	—	dB	
Dropout Voltage	$V_D$	1	$T_j = 25^\circ\text{C}$ , $I_{OUT} = 150\text{ mA}$	—	1.7	—	V	
Average Temperature Coefficient of Output Voltage	$T_{CVO}$	1	$I_{OUT} = 5\text{ mA}$	—	-1.0	—	mV/°C	

TA78L132AP

**ELECTRICAL CHARACTERISTICS**

(Unless otherwise specified,  $V_{IN} = 21\text{ V}$ ,  $I_{OUT} = 40\text{ mA}$ ,  $C_{IN} = 0.33\ \mu\text{F}$ ,  $C_{OUT} = 0.1\ \mu\text{F}$ ,  $0^\circ\text{C} \leq T_j \leq 125^\circ\text{C}$ )

CHARACTERISTIC	SYMBOL	TEST CIR-CUIT	TEST CONDITION	MIN.	TYP.	MAX.	UNIT	
Output Voltage	$V_{OUT}$	1	$T_j = 25^\circ\text{C}$	12.67	13.2	13.73	V	
Line Regulation	Reg·line	1	$T_j = 25^\circ\text{C}$	$16\text{ V} \leq V_{IN} \leq 28\text{ V}$	—	125	270	mV
				$17\text{ V} \leq V_{IN} \leq 28\text{ V}$	—	105	225	
Load Regulation	Reg·load	1	$T_j = 25^\circ\text{C}$	$1.0\text{ mA} \leq I_{OUT} \leq 100\text{ mA}$	—	22	120	mV
				$1.0\text{ mA} \leq I_{OUT} \leq 40\text{ mA}$	—	11	60	
Output Voltage	$V_{OUT}$	1	$T_j = 25^\circ\text{C}$	$16\text{ V} \leq V_{IN} \leq 28\text{ V}$ , $1.0\text{ mA} \leq I_{OUT} \leq 40\text{ mA}$	12.54	—	13.86	V
				$1.0\text{ mA} \leq I_{OUT} \leq 70\text{ mA}$	12.54	—	13.86	
Quiescent Current	$I_B$	1	$T_j = 25^\circ\text{C}$	—	3.2	6.5	mA	
			$T_j = 125^\circ\text{C}$	—	—	6.0		
Quiescent Current Change	$\Delta I_B$	1	$T_j = 25^\circ\text{C}$	$17\text{ V} \leq V_{IN} \leq 28\text{ V}$	—	—	1.5	mA
				$1.0\text{ mA} \leq I_{OUT} \leq 40\text{ mA}$	—	—	0.1	
Output Noise Voltage	$V_{NO}$	2	$T_a = 25^\circ\text{C}$ , $10\text{ Hz} \leq f \leq 100\text{ kHz}$	—	90	—	$\mu\text{V}_{rms}$	
Long Term Stability	$\Delta V_{OUT} / \Delta t$	1	—	—	28	—	mV/kh	
Ripple Rejection	R.R.	3	$f = 120\text{ Hz}$ , $17\text{ V} \leq V_{IN} \leq 27\text{ V}$ , $T_j = 25^\circ\text{C}$	34	41	—	dB	
Dropout Voltage	$V_D$	1	$T_j = 25^\circ\text{C}$ , $I_{OUT} = 150\text{ mA}$	—	1.7	—	V	
Average Temperature Coefficient of Output Voltage	$T_{CVO}$	1	$I_{OUT} = 5\text{ mA}$	—	-1.2	—	mV/°C	

TA78L015AP

**ELECTRICAL CHARACTERISTICS**

(Unless otherwise specified,  $V_{IN} = 23\text{ V}$ ,  $I_{OUT} = 40\text{ mA}$ ,  $C_{IN} = 0.33\ \mu\text{F}$ ,  $C_{OUT} = 0.1\ \mu\text{F}$ ,  $0^\circ\text{C} \leq T_j \leq 125^\circ\text{C}$ )

CHARACTERISTIC	SYMBOL	TEST CIR-CUIT	TEST CONDITION	MIN.	TYP.	MAX.	UNIT	
Output Voltage	$V_{OUT}$	1	$T_j = 25^\circ\text{C}$	14.4	15	15.6	V	
Line Regulation	Reg·line	1	$T_j = 25^\circ\text{C}$	$17.5\text{ V} \leq V_{IN} \leq 30\text{ V}$	—	130	300	mV
				$20\text{ V} \leq V_{IN} \leq 30\text{ V}$	—	110	250	
Load Regulation	Reg·load	1	$T_j = 25^\circ\text{C}$	$1.0\text{ mA} \leq I_{OUT} \leq 100\text{ mA}$	—	25	150	mV
				$1.0\text{ mA} \leq I_{OUT} \leq 40\text{ mA}$	—	12	75	
Output Voltage	$V_{OUT}$	1	$T_j = 25^\circ\text{C}$	$17.5\text{ V} \leq V_{IN} \leq 30\text{ V}$ , $1.0\text{ mA} \leq I_{OUT} \leq 40\text{ mA}$	14.25	—	15.75	V
				$1.0\text{ mA} \leq I_{OUT} \leq 70\text{ mA}$	14.25	—	15.75	
Quiescent Current	$I_B$	1	$T_j = 25^\circ\text{C}$	—	3.3	6.5	mA	
			$T_j = 125^\circ\text{C}$	—	—	6.0		
Quiescent Current Change	$\Delta I_B$	1	$T_j = 25^\circ\text{C}$	$20\text{ V} \leq V_{IN} \leq 30\text{ V}$	—	—	1.5	mA
				$1.0\text{ mA} \leq I_{OUT} \leq 40\text{ mA}$	—	—	0.1	
Output Noise Voltage	$V_{NO}$	2	$T_a = 25^\circ\text{C}$ , $10\text{ Hz} \leq f \leq 100\text{ kHz}$	—	90	—	$\mu\text{V}_{rms}$	
Long Term Stability	$\Delta V_{OUT} / \Delta t$	1	—	—	30	—	mV/kh	
Ripple Rejection	R.R.	3	$f = 120\text{ Hz}$ , $18.5\text{ V} \leq V_{IN} \leq 28.5\text{ V}$ , $T_j = 25^\circ\text{C}$	34	40	—	dB	
Dropout Voltage	$V_D$	1	$T_j = 25^\circ\text{C}$ , $I_{OUT} = 150\text{ mA}$	—	1.7	—	V	
Average Temperature Coefficient of Output Voltage	$T_{CVO}$	1	$I_{OUT} = 5\text{ mA}$	—	-1.3	—	mV/ $^\circ\text{C}$	

TA78L018AP

**ELECTRICAL CHARACTERISTICS**

(Unless otherwise specified,  $V_{IN} = 27\text{ V}$ ,  $I_{OUT} = 40\text{ mA}$ ,  $C_{IN} = 0.33\ \mu\text{F}$ ,  $C_{OUT} = 0.1\ \mu\text{F}$ ,  $0^\circ\text{C} \leq T_j \leq 125^\circ\text{C}$ )

CHARACTERISTIC	SYMBOL	TEST CIR-CUIT	TEST CONDITION	MIN.	TYP.	MAX.	UNIT	
Output Voltage	$V_{OUT}$	1	$T_j = 25^\circ\text{C}$	17.3	18	18.7	V	
Line Regulation	Reg·line	1	$T_j = 25^\circ\text{C}$	$21.4\text{ V} \leq V_{IN} \leq 33\text{ V}$	—	32	325	mV
				$22\text{ V} \leq V_{IN} \leq 33\text{ V}$	—	27	275	
Load Regulation	Reg·load	1	$T_j = 25^\circ\text{C}$	$1.0\text{ mA} \leq I_{OUT} \leq 100\text{ mA}$	—	30	170	mV
				$1.0\text{ mA} \leq I_{OUT} \leq 40\text{ mA}$	—	15	75	
Output Voltage	$V_{OUT}$	1	$T_j = 25^\circ\text{C}$	$21.4\text{ V} \leq V_{IN} \leq 33\text{ V}$ , $1.0\text{ mA} \leq I_{OUT} \leq 40\text{ mA}$	17.1	—	18.9	V
				$1.0\text{ mA} \leq I_{OUT} \leq 70\text{ mA}$	17.1	—	18.9	
Quiescent Current	$I_B$	1	$T_j = 25^\circ\text{C}$	—	3.3	6.5	mA	
			$T_j = 125^\circ\text{C}$	—	—	6.0		
Quiescent Current Change	$\Delta I_B$	1	$T_j = 25^\circ\text{C}$	$22\text{ V} \leq V_{IN} \leq 33\text{ V}$	—	—	1.5	mA
				$1.0\text{ mA} \leq I_{OUT} \leq 40\text{ mA}$	—	—	0.1	
Output Noise Voltage	$V_{NO}$	2	$T_a = 25^\circ\text{C}$ , $10\text{ Hz} \leq f \leq 100\text{ kHz}$	—	150	—	$\mu\text{V}_{rms}$	
Long Term Stability	$\Delta V_{OUT} / \Delta t$	1	—	—	45	—	mV/kh	
Ripple Rejection	R.R.	3	$f = 120\text{ Hz}$ , $23\text{ V} \leq V_{IN} \leq 33\text{ V}$ , $T_j = 25^\circ\text{C}$	32	38	—	dB	
Dropout Voltage	$V_D$	1	$T_j = 25^\circ\text{C}$ , $I_{OUT} = 150\text{ mA}$	—	1.7	—	V	
Average Temperature Coefficient of Output Voltage	$T_{CVO}$	1	$I_{OUT} = 5\text{ mA}$	—	-1.5	—	mV/°C	

TA78L020AP

**ELECTRICAL CHARACTERISTICS**

(Unless otherwise specified,  $V_{IN} = 29\text{ V}$ ,  $I_{OUT} = 40\text{ mA}$ ,  $C_{IN} = 0.33\ \mu\text{F}$ ,  $C_{OUT} = 0.1\ \mu\text{F}$ ,  $0^\circ\text{C} \leq T_j \leq 125^\circ\text{C}$ )

CHARACTERISTIC	SYMBOL	TEST CIR-CUIT	TEST CONDITION	MIN.	TYP.	MAX.	UNIT	
Output Voltage	$V_{OUT}$	1	$T_j = 25^\circ\text{C}$	19.2	20	20.8	V	
Line Regulation	Reg·line	1	$T_j = 25^\circ\text{C}$	$23.5\text{ V} \leq V_{IN} \leq 35\text{ V}$	—	33	330	mV
				$24\text{ V} \leq V_{IN} \leq 35\text{ V}$	—	28	285	
Load Regulation	Reg·load	1	$T_j = 25^\circ\text{C}$	$1.0\text{ mA} \leq I_{OUT} \leq 100\text{ mA}$	—	33	180	mV
				$1.0\text{ mA} \leq I_{OUT} \leq 40\text{ mA}$	—	17	90	
Output Voltage	$V_{OUT}$	1	$T_j = 25^\circ\text{C}$	$23.5\text{ V} \leq V_{IN} \leq 35\text{ V}$ , $1.0\text{ mA} \leq I_{OUT} \leq 40\text{ mA}$	19.0	—	21.0	V
				$1.0\text{ mA} \leq I_{OUT} \leq 70\text{ mA}$	19.0	—	21.0	
Quiescent Current	$I_B$	1	$T_j = 25^\circ\text{C}$	—	3.3	6.5	mA	
			$T_j = 125^\circ\text{C}$	—	—	6.0		
Quiescent Current Change	$\Delta I_B$	1	$T_j = 25^\circ\text{C}$	$24\text{ V} \leq V_{IN} \leq 35\text{ V}$	—	—	1.5	mA
				$1.0\text{ mA} \leq I_{OUT} \leq 40\text{ mA}$	—	—	0.1	
Output Noise Voltage	$V_{NO}$	2	$T_a = 25^\circ\text{C}$ , $10\text{ Hz} \leq f \leq 100\text{ kHz}$	—	170	—	$\mu\text{V}_{rms}$	
Long Term Stability	$\Delta V_{OUT} / \Delta t$	1	—	—	49	—	mV/kh	
Ripple Rejection	R.R.	3	$f = 120\text{ Hz}$ , $25\text{ V} \leq V_{IN} \leq 35\text{ V}$ , $T_j = 25^\circ\text{C}$	31	37	—	dB	
Dropout Voltage	$V_D$	1	$T_j = 25^\circ\text{C}$ , $I_{OUT} = 150\text{ mA}$	—	1.7	—	V	
Average Temperature Coefficient of Output Voltage	$T_{CVO}$	1	$I_{OUT} = 5\text{ mA}$	—	-1.7	—	mV/ $^\circ\text{C}$	

TA78L024AP

**ELECTRICAL CHARACTERISTICS**

(Unless otherwise specified,  $V_{IN} = 33\text{ V}$ ,  $I_{OUT} = 40\text{ mA}$ ,  $C_{IN} = 0.33\ \mu\text{F}$ ,  $C_{OUT} = 0.1\ \mu\text{F}$ ,  $0^\circ\text{C} \leq T_j \leq 125^\circ\text{C}$ )

CHARACTERISTIC	SYMBOL	TEST CIR-CUIT	TEST CONDITION	MIN.	TYP.	MAX.	UNIT	
Output Voltage	$V_{OUT}$	1	$T_j = 25^\circ\text{C}$	23	24	25	V	
Line Regulation	Reg·line	1	$T_j = 25^\circ\text{C}$	$27.5\text{ V} \leq V_{IN} \leq 38\text{ V}$	—	35	350	mV
				$28\text{ V} \leq V_{IN} \leq 38\text{ V}$	—	30	300	
Load Regulation	Reg·load	1	$T_j = 25^\circ\text{C}$	$1.0\text{ mA} \leq I_{OUT} \leq 100\text{ mA}$	—	40	200	mV
				$1.0\text{ mA} \leq I_{OUT} \leq 40\text{ mA}$	—	20	100	
Output Voltage	$V_{OUT}$	1	$T_j = 25^\circ\text{C}$	$27.5\text{ V} \leq V_{IN} \leq 38\text{ V}$ , $1.0\text{ mA} \leq I_{OUT} \leq 40\text{ mA}$	22.8	—	25.2	V
				$1.0\text{ mA} \leq I_{OUT} \leq 70\text{ mA}$	22.8	—	25.2	
Quiescent Current	$I_B$	1	$T_j = 25^\circ\text{C}$	—	3.5	6.5	mA	
			$T_j = 125^\circ\text{C}$	—	—	6.0		
Quiescent Current Change	$\Delta I_B$	1	$T_j = 25^\circ\text{C}$	$28\text{ V} \leq V_{IN} \leq 38\text{ V}$	—	—	1.5	mA
				$1.0\text{ mA} \leq I_{OUT} \leq 40\text{ mA}$	—	—	0.1	
Output Noise Voltage	$V_{NO}$	2	$T_a = 25^\circ\text{C}$ , $10\text{ Hz} \leq f \leq 100\text{ kHz}$	—	200	—	$\mu\text{V}_{rms}$	
Long Term Stability	$\Delta V_{OUT} / \Delta t$	1	—	—	56	—	mV/kh	
Ripple Rejection	R.R.	3	$f = 120\text{ Hz}$ , $29\text{ V} \leq V_{IN} \leq 39\text{ V}$ , $T_j = 25^\circ\text{C}$	31	35	—	dB	
Dropout Voltage	$V_D$	1	$T_j = 25^\circ\text{C}$ , $I_{OUT} = 150\text{ mA}$	—	1.7	—	V	
Average Temperature Coefficient of Output Voltage	$T_{CVO}$	1	$I_{OUT} = 5\text{ mA}$	—	-2.0	—	mV/ $^\circ\text{C}$	

**TEST CIRCUIT 1 / STANDARD APPLICATION**

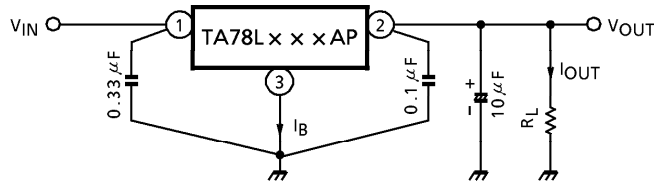

**TEST CIRCUIT 2  $V_{NO}$**

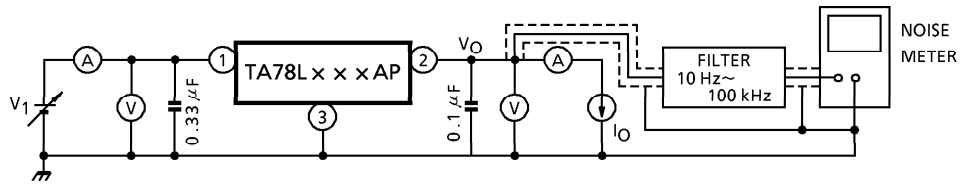

**TEST CIRCUIT 3 R.R.**

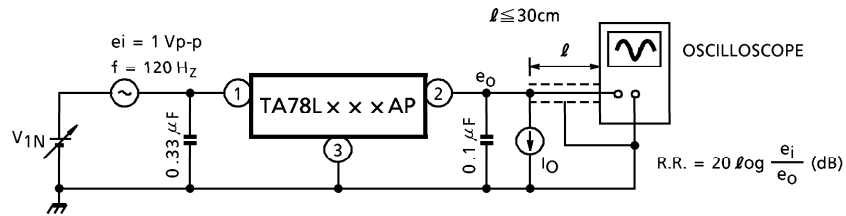



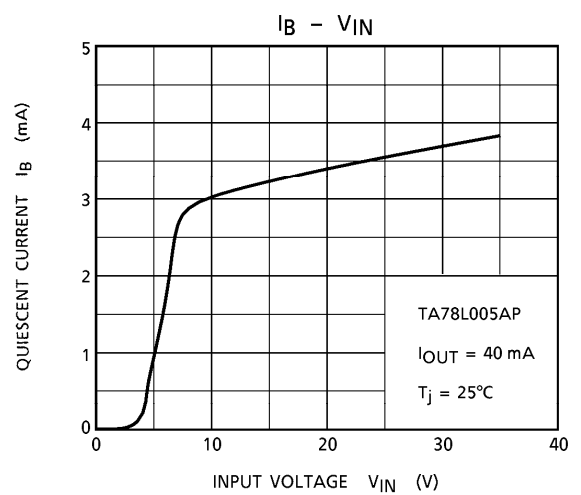
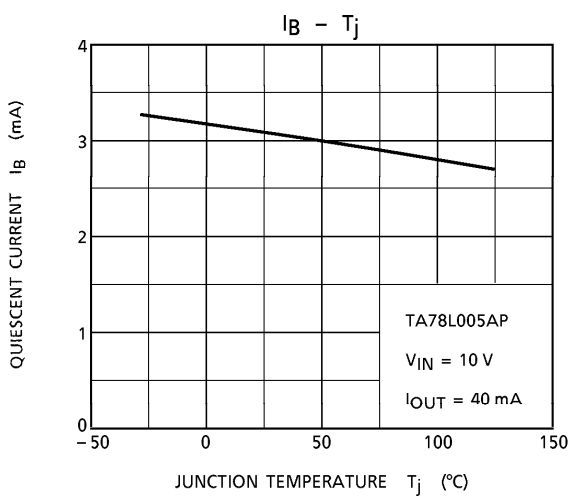
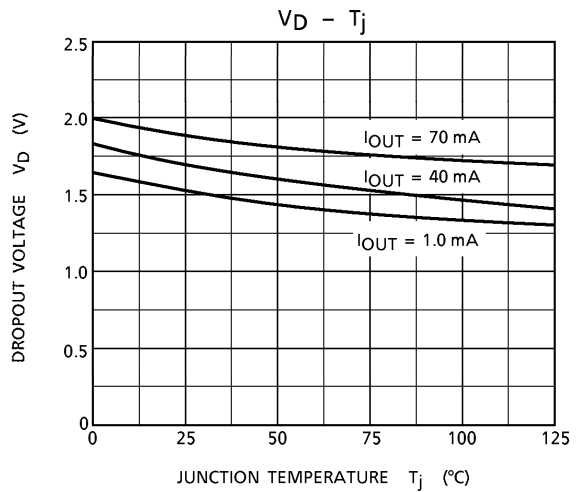
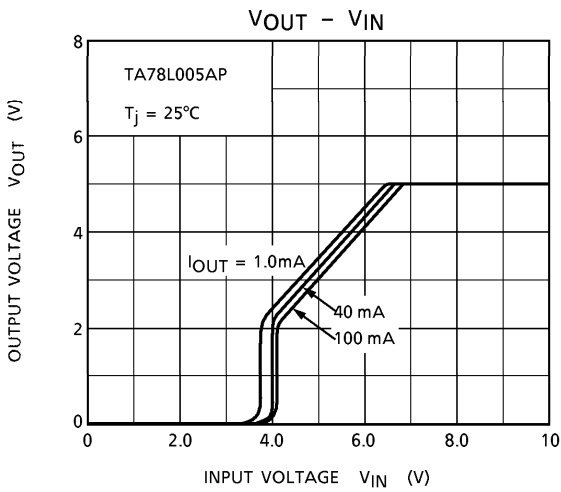
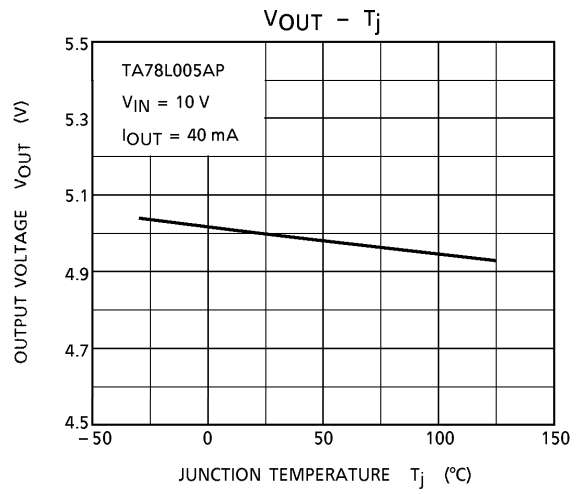
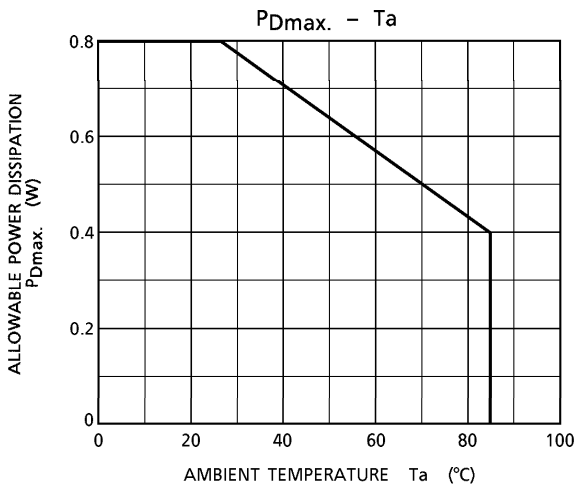

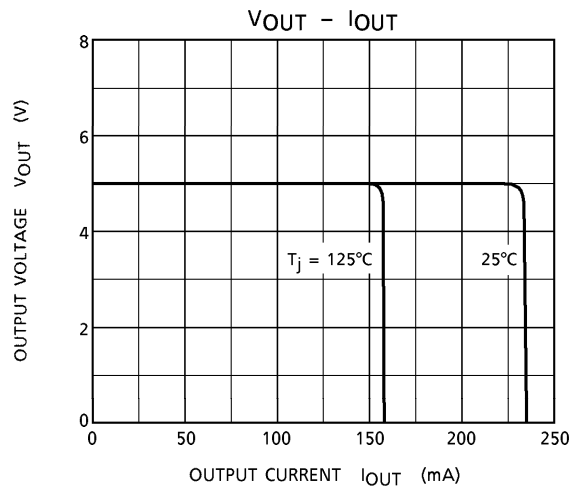
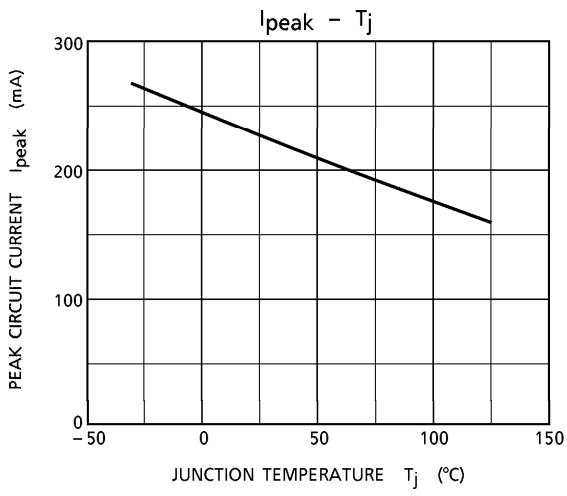

**Precautions for Use**

If high voltage in excess of output voltage (TYP. value) of IC is applied to its output terminal, IC may be destroyed. In this case, connect a Zener diode between the output terminal and GND to prevent application of excessive voltage. In particular, in such a current boosting circuit as shown in Application Circuit Example (2), if input voltage is suddenly applied by stages and furthermore, load is light, excessive voltage may be applied transiently to the output terminal of IC. In such a case as this, it may become necessary to increase capacity of output capacitor as appropriate, use a smaller R<sub>1</sub> (a resistor for bypassing IC bias current) or gradually rise input voltage in addition to use of a Zener diode as mentioned above.

**APPLICATION CIRCUIT**

**(1) STANDARD APPLICATION**

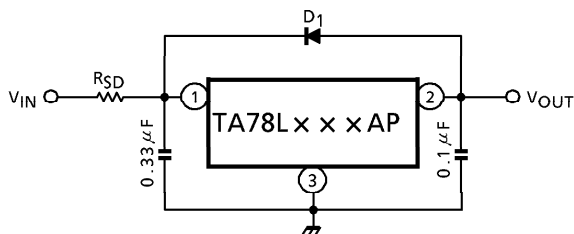

D<sub>1</sub> : IC protective diode  
 When surge voltage is applied to IC output terminal or V<sub>IN</sub> < V<sub>OUT</sub> at the time of power ON/OFF, always connect the high speed swithing diode D<sub>1</sub>.  
 R<sub>SD</sub> : Power limiting resistor  
 If V<sub>IN</sub> is too high, always connect R<sub>SD</sub> in order to reduce power consumption of IC.

**(2) A. CURRENT BOOST VOLTAGE REGULATOR**

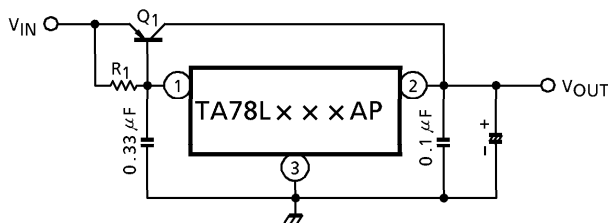

Use a required rediation plate for Q<sub>1</sub>.  

$$R_1 \leq \frac{V_{BE1}}{I_B \text{ MAX}}$$
 where, V<sub>BE1</sub> : V<sub>BE</sub> of external transistor Q<sub>1</sub>.  
 I<sub>B</sub> MAX : Max. bias current of IC.

**B. SHORT-CIRCUIT PROTECTION**

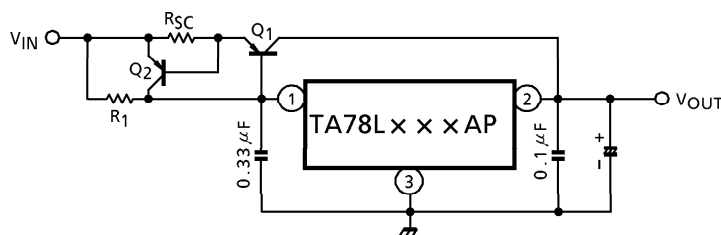

$$R_{SC} = \frac{V_{BE2}}{I_{SC}}$$
 where, I<sub>SC</sub> : Short-Circuit current

(3) CURRENT REGULATOR

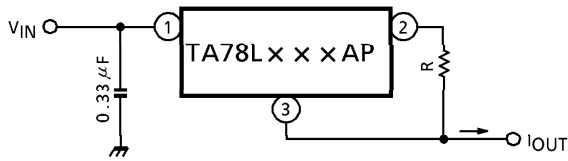

$$I_{OUT} = \frac{V_{OUT}}{R} + I_B$$

(4) VOLTAGE BOOST REGULATOR

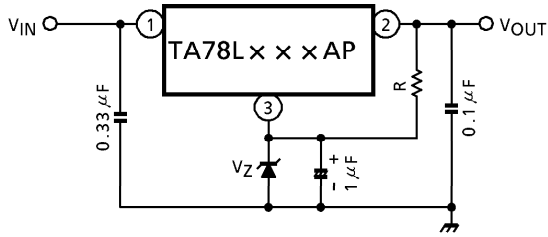

$V_{OUT} = V_Z + V_{OUT}(\text{of IC})$   
A little of current in resistor R is needed.

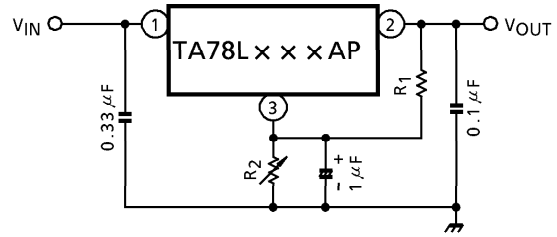

$$V_{OUT} = R_2 (I_B \cdot \frac{V_{OUT}(\text{of IC})}{R_1}) + V_{OUT}(\text{of IC})$$

(5) NEGATIVE REGULATOR

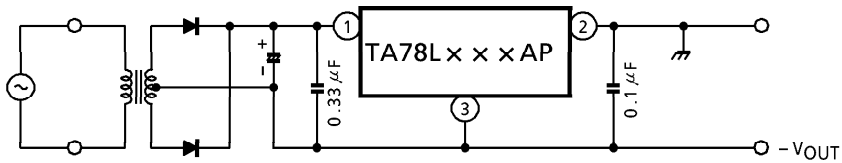

(6) POSITIVE AND NEGATIVE REGULATOR

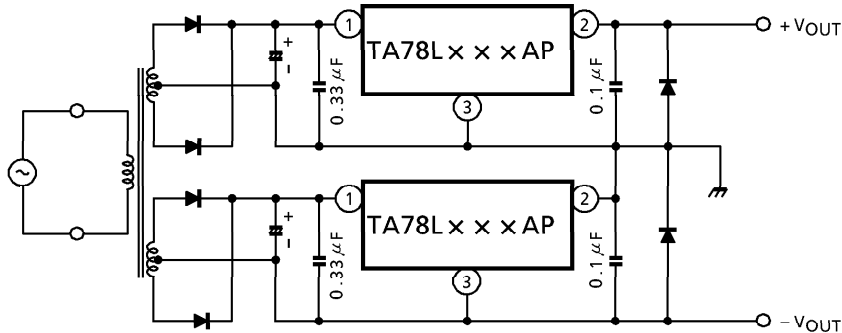

**PACKAGE DIMENSIONS**  
P-SSIP3-1.27

Unit : mm

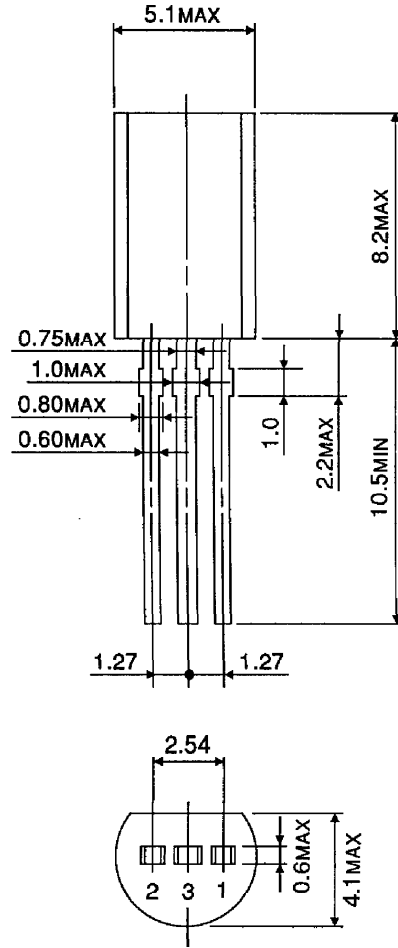

Weight : 0.36g (Typ.)